

SKiiP 38GB17E4V1

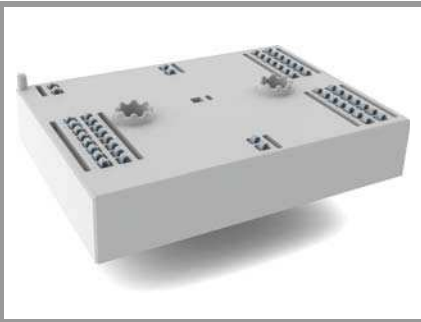

MiniSKiiP® 3 Dual

SKiiP 38GB17E4V1

Features

- Trench IGBTs
- Robust and soft freewheeling diodes in CAL technology
- Highly reliable spring contacts for electrical connections
- UL recognised: File no. E63532
- NTC T-Sensor

Remarks

- Max. case temperature limited to $T_C=125^\circ\text{C}$
- Product reliability results valid for $T_j \leq 150^\circ\text{C}$ (recommended $T_{j,op} = -40 \dots +150^\circ\text{C}$)

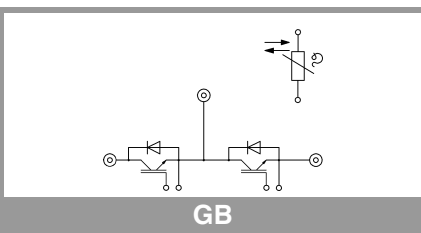

Absolute Maximum Ratings				
Symbol	Conditions	Values	Unit	
Inverter - IGBT				
V_{CES}	$T_j = 25^\circ\text{C}$	1700	V	
I_C	$T_j = 175^\circ\text{C}$	$T_s = 25^\circ\text{C}$	341	A
		$T_s = 70^\circ\text{C}$	277	A
I_{Cnom}		300	A	
I_{CRM}	$I_{CRM} = 3 \times I_{Cnom}$	900	A	
V_{GES}		-20 ... 20	V	
t_{psc}	$V_{CC} = 1000\text{ V}$ $V_{GE} \leq 15\text{ V}$ $V_{CES} \leq 1700\text{ V}$	$T_j = 150^\circ\text{C}$	10	μs
T_j		-40 ... 175	$^\circ\text{C}$	
Inverse - Diode				
I_F	$T_j = 175^\circ\text{C}$	$T_s = 25^\circ\text{C}$	267	A
		$T_s = 70^\circ\text{C}$	209	A
I_{Fnom}		300	A	
I_{FRM}	$I_{FRM} = 2 \times I_{Fnom}$	600	A	
I_{FSM}	10 ms, sin 180°, $T_j = 150^\circ\text{C}$	1566	A	
T_j		-40 ... 175	$^\circ\text{C}$	
Module				
$I_{t(RMS)}$	$T_{terminal} = 80^\circ\text{C}$, 20 A per spring	280	A	
T_{stg}		-40 ... 125	$^\circ\text{C}$	
V_{isol}	AC sinus 50 Hz, t = 1 min	2500	V	

Characteristics					
Symbol	Conditions	min.	typ.	max.	Unit
Inverter - IGBT					
$V_{CE(sat)}$	$I_C = 300\text{ A}$ $V_{GE} = 15\text{ V}$ chipelevel	$T_j = 25^\circ\text{C}$	1.90	2.20	V
		$T_j = 150^\circ\text{C}$	2.30	2.60	V
V_{CE0}	chipelevel	$T_j = 25^\circ\text{C}$	0.8	0.9	V
		$T_j = 150^\circ\text{C}$	0.7	0.8	V
r_{CE}	$V_{GE} = 15\text{ V}$ chipelevel	$T_j = 25^\circ\text{C}$	3.7	4.3	m Ω
		$T_j = 150^\circ\text{C}$	5.3	6	m Ω
$V_{GE(th)}$	$V_{GE} = V_{CE}$, $I_C = 12\text{ mA}$	5.2	5.8	6.4	V
I_{CES}	$V_{GE} = 0\text{ V}$ $V_{CE} = 1700\text{ V}$	$T_j = 25^\circ\text{C}$	0.1	0.3	mA
					mA
C_{ies}	$V_{CE} = 25\text{ V}$		27.20		nF
C_{oes}	$V_{GE} = 0\text{ V}$		1.06		nF
C_{res}			0.88		nF
Q_G	- 8 V...+ 15 V		2400		nC
R_{Gint}	$T_j = 25^\circ\text{C}$		2.1		Ω
$t_{d(on)}$	$V_{CC} = 900\text{ V}$ $I_C = 300\text{ A}$		216		ns
t_r	$R_{Gon} = 2\ \Omega$		52		ns
E_{on}	$R_{Goff} = 2\ \Omega$		47		mJ
$t_{d(off)}$	$di/dt_{on} = 7900\text{ A}/\mu\text{s}$		697		ns
t_f	$di/dt_{off} = 2025\text{ A}/\mu\text{s}$		167		ns
E_{off}	$du/dt = 5084\text{ V}/\mu\text{s}$ $V_{GE} = +15/-15\text{ V}$ $L_s = 25\text{ nH}$		102		mJ
$R_{th(j-s)}$	per IGBT, $\lambda_{paste} = 0.8\text{ W}/\text{K} \cdot \text{m}$		0.15		K/W

SKiiP 38GB17E4V1

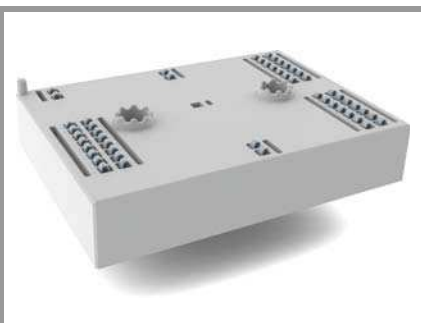

MiniSKiiP® 3 Dual

SKiiP 38GB17E4V1

Features

- Trench IGBTs
- Robust and soft freewheeling diodes in CAL technology
- Highly reliable spring contacts for electrical connections
- UL recognised: File no. E63532
- NTC T-Sensor

Remarks

- Max. case temperature limited to $T_C=125^\circ\text{C}$
- Product reliability results valid for $T_j \leq 150^\circ\text{C}$ (recommended $T_{j,op} = -40 \dots +150^\circ\text{C}$)

Characteristics						
Symbol	Conditions		min.	typ.	max.	Unit
Inverse - Diode						
$V_F = V_{EC}$	$I_F = 300 \text{ A}$ $V_{GE} = 0 \text{ V}$ chipelevel	$T_j = 25^\circ\text{C}$		2	2.4	V
		$T_j = 150^\circ\text{C}$		2.2	2.6	V
V_{F0}	chipelevel	$T_j = 25^\circ\text{C}$		1.3	1.6	V
		$T_j = 150^\circ\text{C}$		1.1	1.2	V
r_F	chipelevel	$T_j = 25^\circ\text{C}$		2.3	2.8	m Ω
		$T_j = 150^\circ\text{C}$		3.6	4.5	m Ω
I_{RRM}	$I_F = 300 \text{ A}$			517		A
Q_{rr}	$di/dt_{off} = 8569 \text{ A}/\mu\text{s}$			100		μC
E_{rr}	$V_{GE} = -15 \text{ V}$ $V_{CC} = 900 \text{ V}$			69		mJ
$R_{th(j-s)}$	per Diode, $\lambda_{paste}=0.8 \text{ W}/\text{K}\cdot\text{m}$			0.24		K/W
Module						
L_{CE}				15		nH
M_s	to heat sink		2		2.5	Nm
w				76		g
Temperature Sensor						
R_{100}	$T_c=100^\circ\text{C}$ ($R_{25}=5 \text{ k}\Omega$)			$493 \pm 5\%$		Ω
$B_{25/85}$	$R(T)=R_{25} \cdot \exp[B_{25/85} \cdot (1/T - 1/298)]$, [T]=K			3420		K

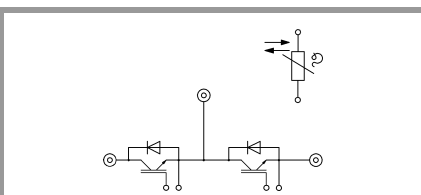

GB

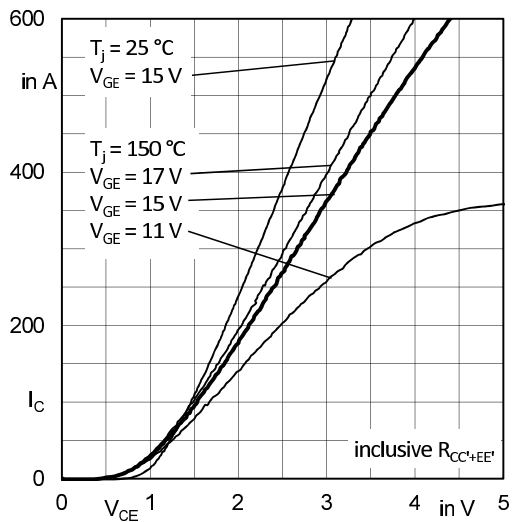

Fig. 1: Typ. output characteristic, inclusive $R_{CC+EE'}$

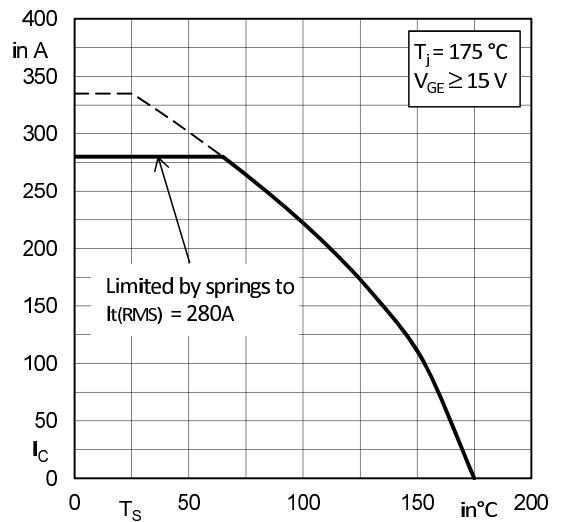

Fig. 2: Rated current vs. temperature $I_C = f(T_S)$

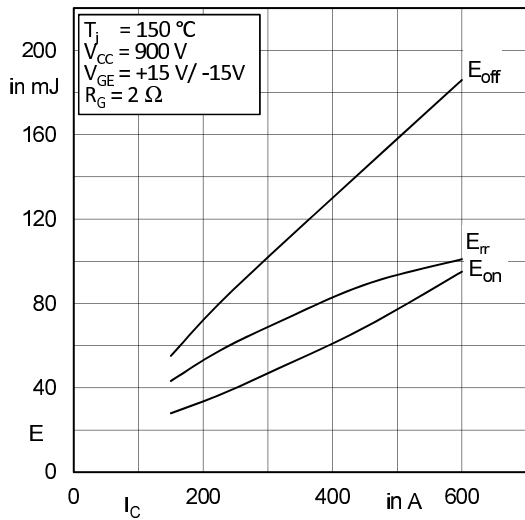

Fig. 3: Typ. turn-on /-off energy = $f(I_C)$

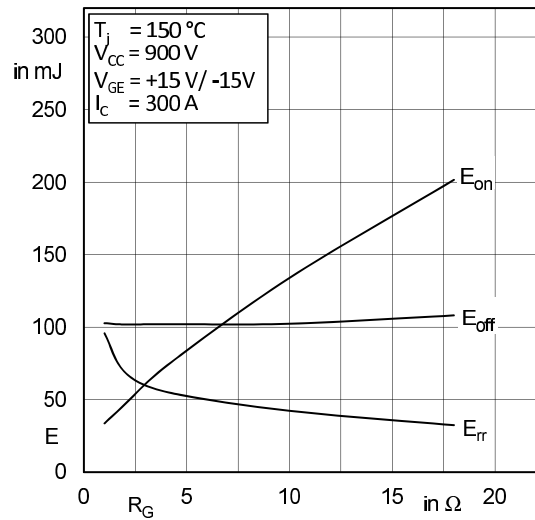

Fig. 4: Typ. turn-on /-off energy = $f(R_G)$

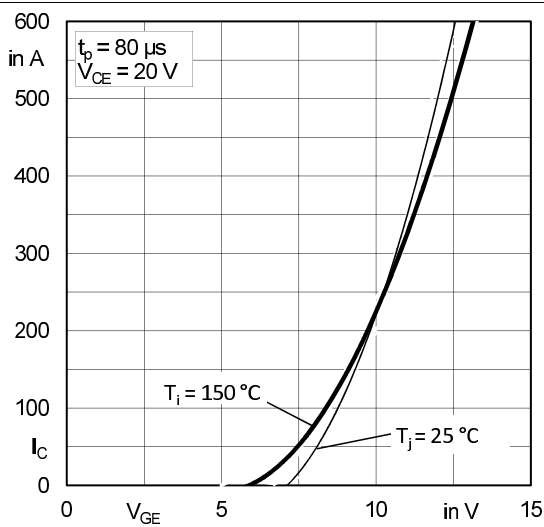

Fig. 5: Typ. transfer characteristic

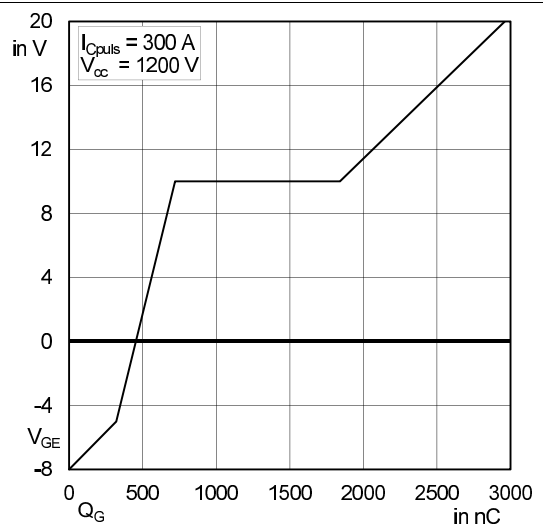

Fig. 6: Typ. gate charge characteristic

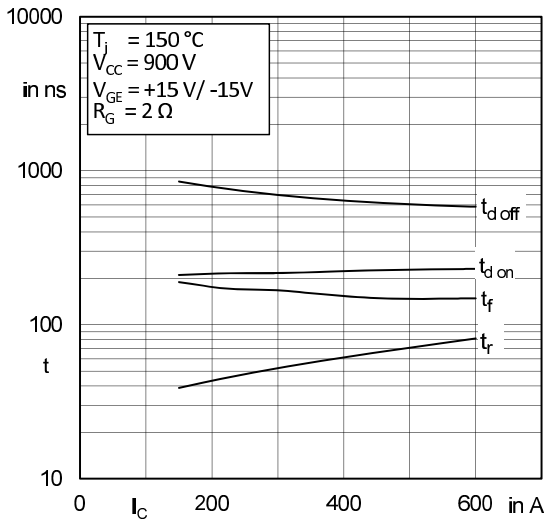

Fig. 7: Typ. switching times vs. I_C

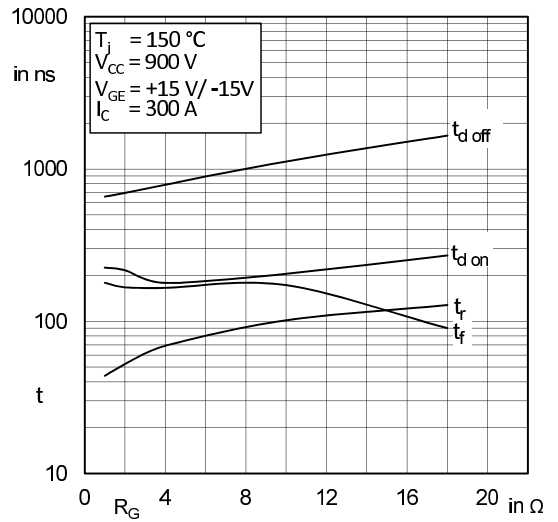

Fig. 8: Typ. switching times vs. gate resistor R_G

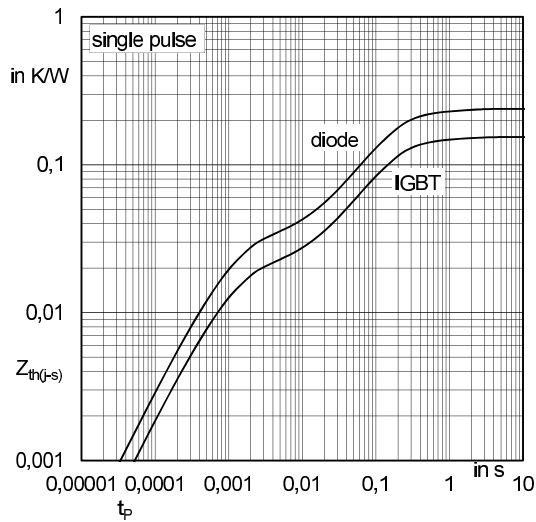

Fig. 9: Transient thermal impedance of IGBT and Diode

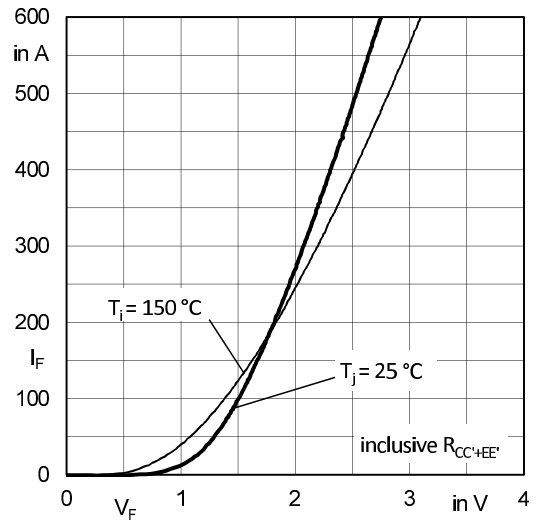

Fig. 10: CAL diode forward characteristic

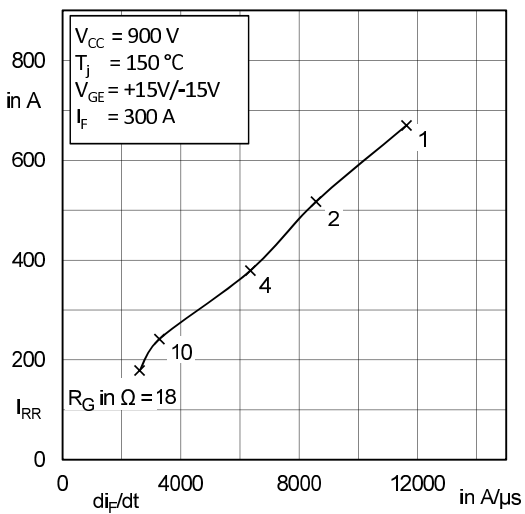

Fig. 11: Typ. CAL diode peak reverse recovery current

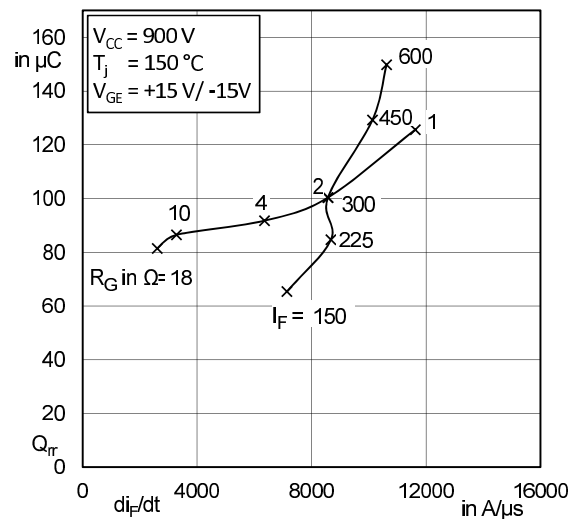
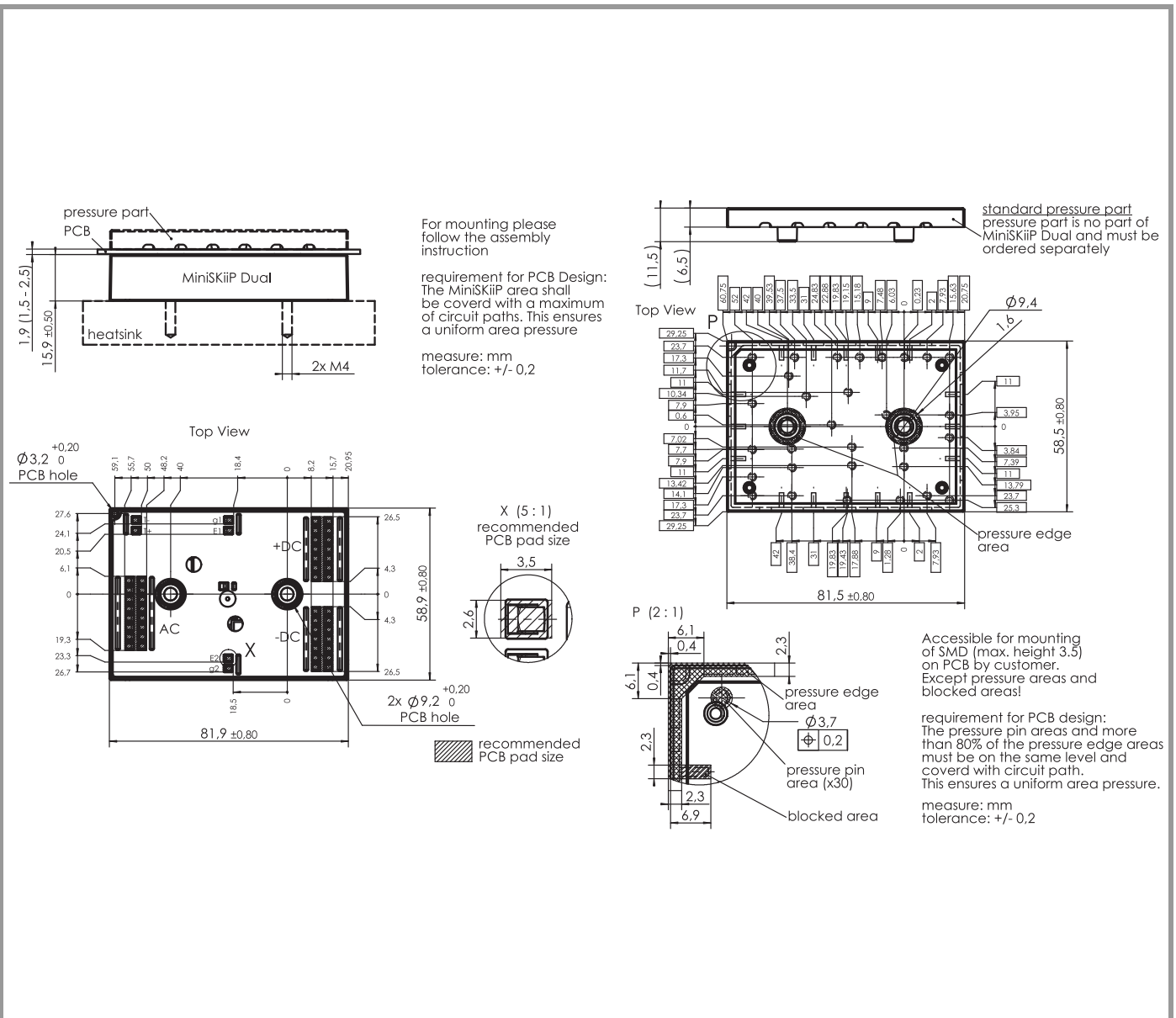
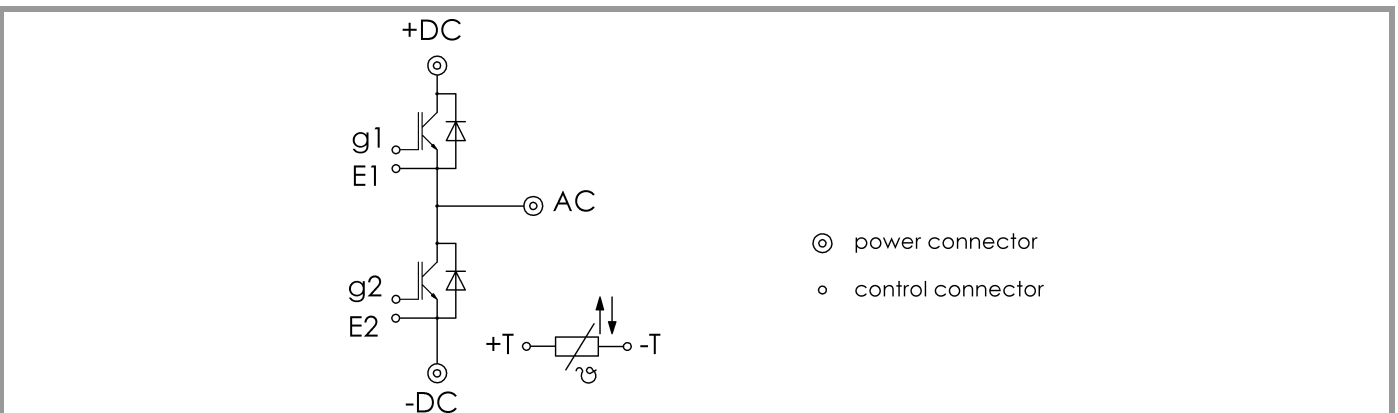

Fig. 12: Typ. CAL diode recovery charge

SKiIP 38GB17E4V1



pinout, dimensions



pinout

This is an electrostatic discharge sensitive device (ESDS), international standard IEC 60747-1, Chapter IX

* The specifications of our components may not be considered as an assurance of component characteristics. Components have to be tested for the respective application. Adjustments may be necessary. The use of SEMIKRON products in life support appliances and systems is subject to prior specification and written approval by SEMIKRON. We therefore strongly recommend prior consultation of our staff.