

SKiIP 39MLI12T4V1

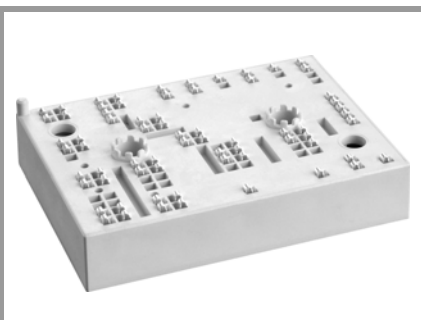

MiniSKiIP® 3

3-Level NPC IGBT-Module

SKiIP 39MLI12T4V1

Features

- Trench 4 IGBTs
- Robust and soft freewheeling diodes in CAL technology
- Highly reliable spring contacts for electrical connections
- UL recognised: File no. E63532
- NTC T-Sensor

Remarks*

- Max. case temperature limited to $T_C = 125^\circ\text{C}$
- Product reliability results valid for $T_j \leq 150^\circ\text{C}$ (recommended $T_{j,op} = -40 \dots +150^\circ\text{C}$)
- IGBT1: outer IGBTs T1 & T4
- IGBT2: inner IGBTs T2 & T3
- Diode1: outer diodes D1 & D4
- Diode2: inner diodes D2 & D3
- Diode5: clamping diodes D5 & D6

Footnotes

¹⁾ Please find further technical information on the SEMIKRON website.

Absolute Maximum Ratings				
Symbol	Conditions	Values	Unit	
IGBT1				
V_{CES}	$T_j = 25^\circ\text{C}$	1200	V	
I_C	$\lambda_{paste}=0.8 \text{ W/(mK)}$	$T_s = 25^\circ\text{C}$	159	A
	$T_j = 175^\circ\text{C}$	$T_s = 70^\circ\text{C}$	128	A
I_C	$\lambda_{paste}=2.5 \text{ W/(mK)}$	$T_s = 25^\circ\text{C}$	196	A
	$T_j = 175^\circ\text{C}$	$T_s = 70^\circ\text{C}$	160	A
I_{Cnom}		150	A	
I_{CRM}	$I_{CRM} = 3 \times I_{Cnom}$	450	A	
V_{GES}		-20 ... 20	V	
t_{psc}	$V_{CC} = 800 \text{ V}, V_{GE} \leq 15 \text{ V}, T_j = 150^\circ\text{C}, V_{CES} \leq 1200 \text{ V}$	10	μs	
T_j		-40 ... 175	$^\circ\text{C}$	
IGBT2				
V_{CES}	$T_j = 25^\circ\text{C}$	1200	V	
I_C	$\lambda_{paste}=0.8 \text{ W/(mK)}$	$T_s = 25^\circ\text{C}$	164	A
	$T_j = 175^\circ\text{C}$	$T_s = 70^\circ\text{C}$	133	A
I_C	$\lambda_{paste}=2.5 \text{ W/(mK)}$	$T_s = 25^\circ\text{C}$	201	A
	$T_j = 175^\circ\text{C}$	$T_s = 70^\circ\text{C}$	163	A
I_{Cnom}		150	A	
I_{CRM}	$I_{CRM} = 3 \times I_{Cnom}$	450	A	
V_{GES}		-20 ... 20	V	
t_{psc}	$V_{CC} = 800 \text{ V}, V_{GE} \leq 15 \text{ V}, T_j = 150^\circ\text{C}, V_{CES} \leq 1200 \text{ V}$	10	μs	
T_j		-40 ... 175	$^\circ\text{C}$	
Diode1				
V_{RRM}	$T_j = 25^\circ\text{C}$	1200	V	
I_F	$\lambda_{paste}=0.8 \text{ W/(mK)}$	$T_s = 25^\circ\text{C}$	120	A
	$T_j = 175^\circ\text{C}$	$T_s = 70^\circ\text{C}$	94	A
I_F	$\lambda_{paste}=2.5 \text{ W/(mK)}$	$T_s = 25^\circ\text{C}$	145	A
	$T_j = 175^\circ\text{C}$	$T_s = 70^\circ\text{C}$	115	A
I_{Fnom}		150	A	
I_{FRM}	$I_{FRM} = 2 \times I_{Fnom}$	300	A	
I_{FSM}	10 ms, sin 180°, $T_j = 25^\circ\text{C}$	900	A	
T_j		-40 ... 175	$^\circ\text{C}$	
Diode2				
V_{RRM}	$T_j = 25^\circ\text{C}$	1200	V	
I_F	$\lambda_{paste}=0.8 \text{ W/(mK)}$	$T_s = 25^\circ\text{C}$	131	A
	$T_j = 175^\circ\text{C}$	$T_s = 70^\circ\text{C}$	103	A
I_F	$\lambda_{paste}=2.5 \text{ W/(mK)}$	$T_s = 25^\circ\text{C}$	158	A
	$T_j = 175^\circ\text{C}$	$T_s = 70^\circ\text{C}$	126	A
I_{Fnom}		150	A	
I_{FRM}	$I_{FRM} = 2 \times I_{Fnom}$	300	A	
I_{FSM}	10 ms, sin 180°, $T_j = 25^\circ\text{C}$	900	A	
T_j		-40 ... 175	$^\circ\text{C}$	

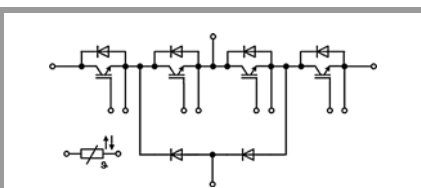

MLI

SKiIP 39MLI12T4V1

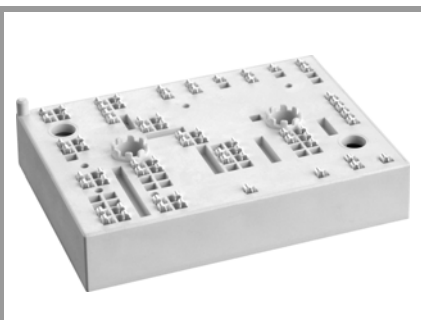

MiniSKiIP® 3

3-Level NPC IGBT-Module

SKiIP 39MLI12T4V1

Features

- Trench 4 IGBTs
- Robust and soft freewheeling diodes in CAL technology
- Highly reliable spring contacts for electrical connections
- UL recognised: File no. E63532
- NTC T-Sensor

Remarks*

- Max. case temperature limited to $T_C = 125^\circ\text{C}$
- Product reliability results valid for $T_j \leq 150^\circ\text{C}$ (recommended $T_{j,op} = -40 \dots +150^\circ\text{C}$)
- IGBT1: outer IGBTs T1 & T4
- IGBT2: inner IGBTs T2 & T3
- Diode1: outer diodes D1 & D4
- Diode2: inner diodes D2 & D3
- Diode5: clamping diodes D5 & D6

Footnotes

¹⁾ Please find further technical information on the SEMIKRON website.

Absolute Maximum Ratings				
Symbol	Conditions	Values	Unit	
Diode5				
V_{RRM}	$T_j = 25^\circ\text{C}$	1200	V	
I_F	$\lambda_{paste} = 0.8 \text{ W/(mK)}$	$T_s = 25^\circ\text{C}$	119	A
	$T_j = 175^\circ\text{C}$	$T_s = 70^\circ\text{C}$	93	A
I_F	$\lambda_{paste} = 2.5 \text{ W/(mK)}$	$T_s = 25^\circ\text{C}$	145	A
	$T_j = 175^\circ\text{C}$	$T_s = 70^\circ\text{C}$	115	A
I_{Fnom}		150	A	
I_{FRM}	$I_{FRM} = 2 \times I_{Fnom}$	300	A	
I_{FSM}	10 ms, sin 180°, $T_j = 25^\circ\text{C}$	900	A	
T_j		-40 ... 175	$^\circ\text{C}$	
Module				
$I_{t(RMS)}$		160	A	
T_{stg}		-40 ... 125	$^\circ\text{C}$	
V_{isol}	AC sinus 50 Hz, $t = 1 \text{ min}$	2500	V	

Characteristics					
Symbol	Conditions	min.	typ.	max.	Unit
IGBT1					
$V_{CE(sat)}$	$I_C = 150 \text{ A}$ $V_{GE} = 15 \text{ V}$ chipelevel	$T_j = 25^\circ\text{C}$	1.85	2.10	V
		$T_j = 150^\circ\text{C}$	2.25	2.45	V
V_{CE0}	chipelevel	$T_j = 25^\circ\text{C}$	0.80	0.90	V
		$T_j = 150^\circ\text{C}$	0.70	0.80	V
r_{CE}	$V_{GE} = 15 \text{ V}$ chipelevel	$T_j = 25^\circ\text{C}$	7.0	8.0	$\text{m}\Omega$
		$T_j = 150^\circ\text{C}$	10	11	$\text{m}\Omega$
$V_{GE(th)}$	$V_{GE} = V_{CE}, I_C = 6 \text{ mA}$	5	5.8	6.5	V
I_{CES}	$V_{GE} = 0 \text{ V}, V_{CE} = 1200 \text{ V}, T_j = 25^\circ\text{C}$			0.3	mA
C_{ies}	$V_{CE} = 25 \text{ V}$ $V_{GE} = 0 \text{ V}$	$f = 1 \text{ MHz}$	8.80		nF
C_{oes}		$f = 1 \text{ MHz}$	0.58		nF
C_{res}		$f = 1 \text{ MHz}$	0.47		nF
Q_G	$V_{GE} = -8 \text{ V} \dots +15 \text{ V}$		850		nC
R_{Gint}	$T_j = 25^\circ\text{C}$		5.0		Ω
$t_{d(on)}$	$V_{CE} = 600 \text{ V}$ $I_C = 150 \text{ A}$	$T_j = 150^\circ\text{C}$	129		ns
t_r	$V_{GE} = +15/-15 \text{ V}$	$T_j = 150^\circ\text{C}$	37		ns
E_{on}	$R_{G on} = 1 \Omega$	$T_j = 150^\circ\text{C}$	17		mJ
$t_{d(off)}$	$R_{G off} = 1 \Omega$	$T_j = 150^\circ\text{C}$	355		ns
t_f	$di/dt_{on} = 4000 \text{ A}/\mu\text{s}$ $di/dt_{off} = 1700 \text{ A}/\mu\text{s}$	$T_j = 150^\circ\text{C}$	77		ns
E_{off}	$du/dt = 3800 \text{ V}/\mu\text{s}$ $L_s = 25 \text{ nH}$	$T_j = 150^\circ\text{C}$	15		mJ
$R_{th(j-s)}$	per IGBT, $\lambda_{paste} = 0.8 \text{ W/(mK)}$		0.36		K/W
$R_{th(j-s)}$	per IGBT, $\lambda_{paste} = 2.5 \text{ W/(mK)}$		0.25		K/W

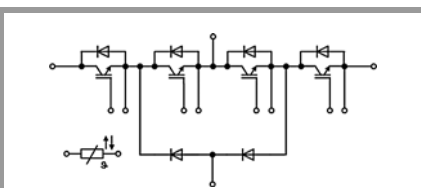

MLI

SKiIP 39MLI12T4V1

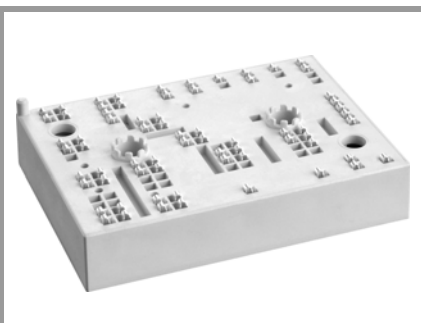

MiniSKiIP® 3

3-Level NPC IGBT-Module

SKiIP 39MLI12T4V1

Features

- Trench 4 IGBTs
- Robust and soft freewheeling diodes in CAL technology
- Highly reliable spring contacts for electrical connections
- UL recognised: File no. E63532
- NTC T-Sensor

Remarks*

- Max. case temperature limited to $T_C = 125^\circ\text{C}$
- Product reliability results valid for $T_j \leq 150^\circ\text{C}$ (recommended $T_{j,op} = -40 \dots +150^\circ\text{C}$)
- IGBT1: outer IGBTs T1 & T4
- IGBT2: inner IGBTs T2 & T3
- Diode1: outer diodes D1 & D4
- Diode2: inner diodes D2 & D3
- Diode5: clamping diodes D5 & D6

Footnotes

¹⁾ Please find further technical information on the SEMIKRON website.

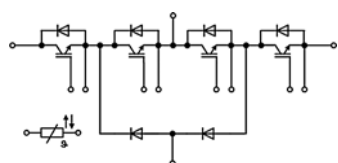

MLI

Characteristics						
Symbol	Conditions		min.	typ.	max.	Unit
IGBT2						
$V_{CE(sat)}$	$I_C = 150\text{ A}$ $V_{GE} = 15\text{ V}$ chipelevel	$T_j = 25^\circ\text{C}$	1.85	2.10		V
		$T_j = 150^\circ\text{C}$	2.25	2.45		V
V_{CE0}	chipelevel	$T_j = 25^\circ\text{C}$	0.80	0.90		V
		$T_j = 150^\circ\text{C}$	0.70	0.80		V
r_{CE}	$V_{GE} = 15\text{ V}$ chipelevel	$T_j = 25^\circ\text{C}$	7.0	8.0		m Ω
		$T_j = 150^\circ\text{C}$	10	11		m Ω
$V_{GE(th)}$	$V_{GE} = V_{CE}, I_C = 6\text{ mA}$		5	5.8	6.5	V
I_{CES}	$V_{GE} = 0\text{ V}, V_{CE} = 1200\text{ V}, T_j = 25^\circ\text{C}$				0.3	mA
C_{ies}	$V_{CE} = 25\text{ V}$ $V_{GE} = 0\text{ V}$	$f = 1\text{ MHz}$		8.80		nF
C_{oes}		$f = 1\text{ MHz}$		0.58		nF
C_{res}		$f = 1\text{ MHz}$		0.47		nF
Q_G	$V_{GE} = -8\text{ V} \dots +15\text{ V}$			850		nC
R_{Gint}	$T_j = 25^\circ\text{C}$			5.0		Ω
$t_{d(on)}$	$V_{CC} = 600\text{ V}$	$T_j = 150^\circ\text{C}$		128		ns
t_r	$I_C = 150\text{ A}$	$T_j = 150^\circ\text{C}$		44		ns
E_{on}	$V_{GE} = +15/-15\text{ V}$	$T_j = 150^\circ\text{C}$		16.5		mJ
$t_{d(off)}$	$R_{Gon} = 1\ \Omega$	$T_j = 150^\circ\text{C}$		360		ns
t_f	$R_{Goff} = 1\ \Omega$	$T_j = 150^\circ\text{C}$		67		ns
E_{off}	$di/dt_{on} = 3200\text{ A}/\mu\text{s}$	$T_j = 150^\circ\text{C}$				
	$du/dt = 4400\text{ V}/\mu\text{s}$ $L_s = 25\text{ nH}$	$T_j = 150^\circ\text{C}$		15		mJ
$R_{th(j-s)}$	per IGBT, $\lambda_{paste} = 0.8\text{ W}/(\text{mK})$			0.34		K/W
$R_{th(j-s)}$	per IGBT, $\lambda_{paste} = 2.5\text{ W}/(\text{mK})$			0.24		K/W
Diode1						
$V_F = V_{EC}$	$I_F = 150\text{ A}$ $V_{GE} = 0\text{ V}$ chipelevel	$T_j = 25^\circ\text{C}$	2.14	2.46		V
		$T_j = 150^\circ\text{C}$	2.07	2.38		V
V_{F0}	chipelevel	$T_j = 25^\circ\text{C}$	1.30	1.50		V
		$T_j = 150^\circ\text{C}$	0.90	1.10		V
r_F	chipelevel	$T_j = 25^\circ\text{C}$	5.6	6.4		m Ω
		$T_j = 150^\circ\text{C}$	7.8	8.5		m Ω
I_{RRM}	$I_F = 150\text{ A}$	$T_j = 150^\circ\text{C}$		143		A
Q_{rr}	$di/dt_{off} = 3200\text{ A}/\mu\text{s}$ $V_R = 600\text{ V}$	$T_j = 150^\circ\text{C}$		34		μC
E_{rr}	$V_{GE} = +15/-15\text{ V}$ $L_s = 25\text{ nH}$	$T_j = 150^\circ\text{C}$		13		mJ
$R_{th(j-s)}$	per Diode, $\lambda_{paste} = 0.8\text{ W}/(\text{mK})$			0.63		K/W
$R_{th(j-s)}$	per Diode, $\lambda_{paste} = 2.5\text{ W}/(\text{mK})$			0.47		K/W
Diode2						
$V_F = V_{EC}$	$I_F = 150\text{ A}$ $V_{GE} = 0\text{ V}$ chipelevel	$T_j = 25^\circ\text{C}$	2.14	2.46		V
		$T_j = 150^\circ\text{C}$	2.07	2.38		V
V_{F0}	chipelevel	$T_j = 25^\circ\text{C}$	1.30	1.50		V
		$T_j = 150^\circ\text{C}$	0.90	1.10		V
r_F	level = chipelevel	$T_j = 25^\circ\text{C}$	5.6	6.4		m Ω
		$T_j = 150^\circ\text{C}$	7.8	8.5		m Ω
I_{RRM}	$I_F = 150\text{ A}$	$T_j = 150^\circ\text{C}$		-		A
Q_{rr}	$V_R = 600\text{ V}$	$T_j = 150^\circ\text{C}$		-		μC
E_{rr} ¹⁾	$V_{GE} = +15/-15\text{ V}$	$T_j = 150^\circ\text{C}$		-		mJ
$R_{th(j-s)}$	per Diode, $\lambda_{paste} = 0.8\text{ W}/(\text{mK})$			0.55		K/W
$R_{th(j-s)}$	per Diode, $\lambda_{paste} = 2.5\text{ W}/(\text{mK})$			0.41		K/W

SKiIP 39MLI12T4V1

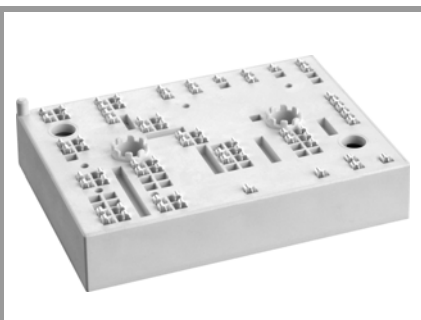

MiniSKiIP® 3

3-Level NPC IGBT-Module

SKiIP 39MLI12T4V1

Features

- Trench 4 IGBTs
- Robust and soft freewheeling diodes in CAL technology
- Highly reliable spring contacts for electrical connections
- UL recognised: File no. E63532
- NTC T-Sensor

Remarks*

- Max. case temperature limited to $T_C=125^\circ\text{C}$
- Product reliability results valid for $T_j \leq 150^\circ\text{C}$ (recommended $T_{j,op} = -40 \dots +150^\circ\text{C}$)
- IGBT1: outer IGBTs T1 & T4
- IGBT2: inner IGBTs T2 & T3
- Diode1: outer diodes D1 & D4
- Diode2: inner diodes D2 & D3
- Diode5: clamping diodes D5 & D6

Footnotes

¹⁾ Please find further technical information on the SEMIKRON website.

Characteristics						
Symbol	Conditions		min.	typ.	max.	Unit
Diode5						
$V_F = V_{EC}$	$I_F = 150\text{ A}$ $V_{GE} = 0\text{ V}$ chipllevel	$T_j = 25^\circ\text{C}$		2.14	2.46	V
		$T_j = 150^\circ\text{C}$		2.07	2.38	V
V_{F0}	chipllevel	$T_j = 25^\circ\text{C}$		1.30	1.50	V
		$T_j = 150^\circ\text{C}$		0.90	1.10	V
r_F	chipllevel	$T_j = 25^\circ\text{C}$		5.6	6.4	m Ω
		$T_j = 150^\circ\text{C}$		7.8	8.5	m Ω
I_{RRM}	$I_F = 150\text{ A}$	$T_j = 150^\circ\text{C}$		177		A
Q_{rr}	$di/dt_{off} = 3900\text{ A}/\mu\text{s}$ $V_R = 600\text{ V}$	$T_j = 150^\circ\text{C}$		32		μC
E_{rr}	$V_{GE} = +15/-15\text{ V}$ $L_s = 25\text{ nH}$	$T_j = 150^\circ\text{C}$		12.6		mJ
$R_{th(j-s)}$	per Diode, $\lambda_{paste}=0.8\text{ W}/(\text{mK})$			0.64		K/W
$R_{th(j-s)}$	per Diode, $\lambda_{paste}=2.5\text{ W}/(\text{mK})$			0.47		K/W
Module						
L_{sCE1}				-		nH
L_{sCE2}				-		nH
R_{CC+EE}			$T_s = 25^\circ\text{C}$		-	m Ω
					-	m Ω
M_s	to heat sink			2	2.5	Nm
M_t	to heat sink					Nm
						Nm
w				82		g
Temperature Sensor						
R_{100}	$T_c=100^\circ\text{C}$ ($R_{25}=5\text{ k}\Omega$)			$493 \pm 5\%$		Ω
$B_{100/125}$	$R(T)=R_{100}\exp[B_{100/125}(1/T-1/T_{100})]$; $T[\text{K}]$;			$3550 \pm 2\%$		K

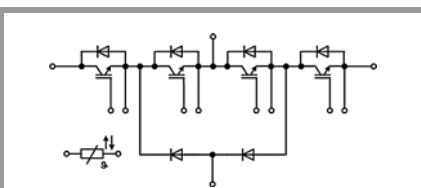

MLI

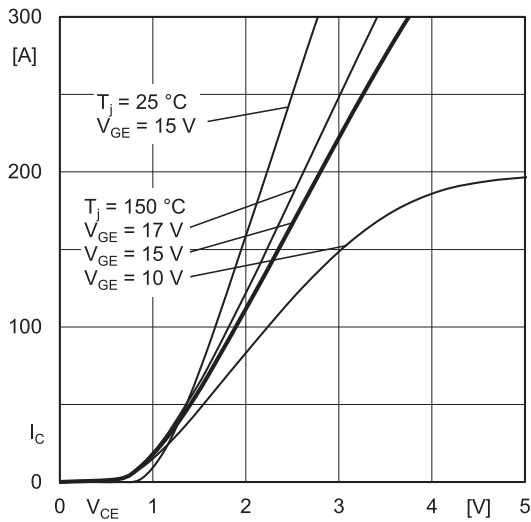

Fig. 1: Typ. IGBT1 output characteristic, incl. $R_{CC'+EE'}$

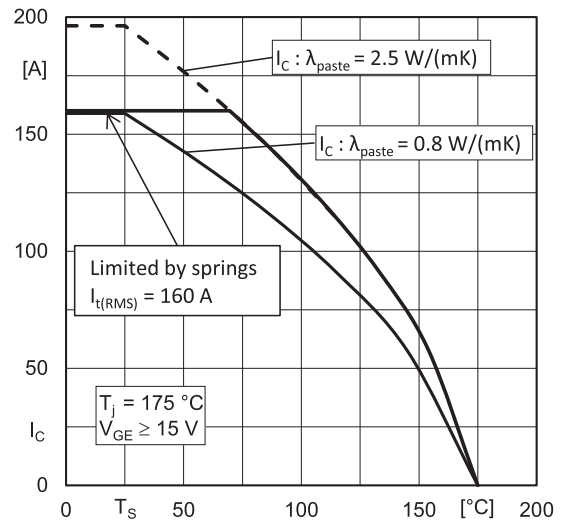

Fig. 2: IGBT1 rated current vs. Temperature $I_c=f(T_s)$

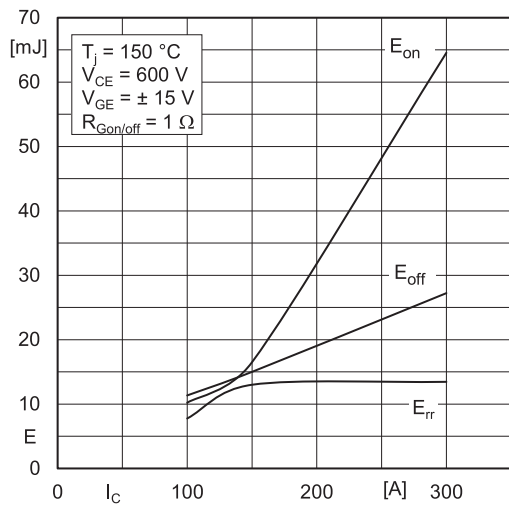

Fig. 3: Typ. IGBT1 & Diode5 turn-on /-off energy = $f(I_c)$

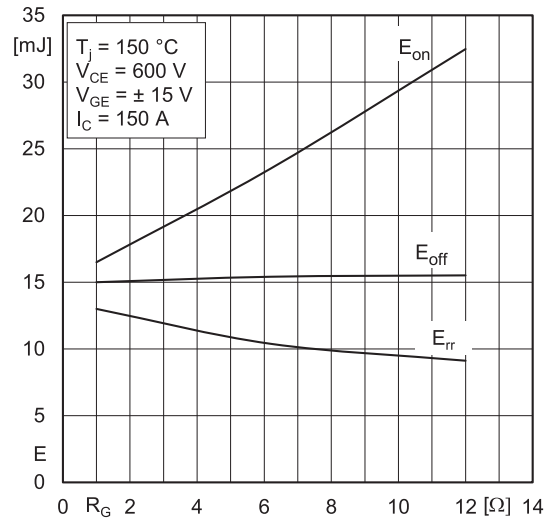

Fig. 4: Typ. IGBT1 & Diode5 turn-on /-off energy = $f(R_G)$

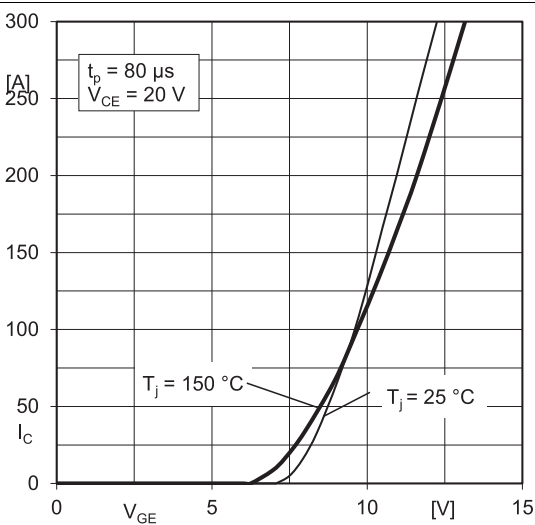

Fig. 5: Typ. IGBT1 transfer characteristic

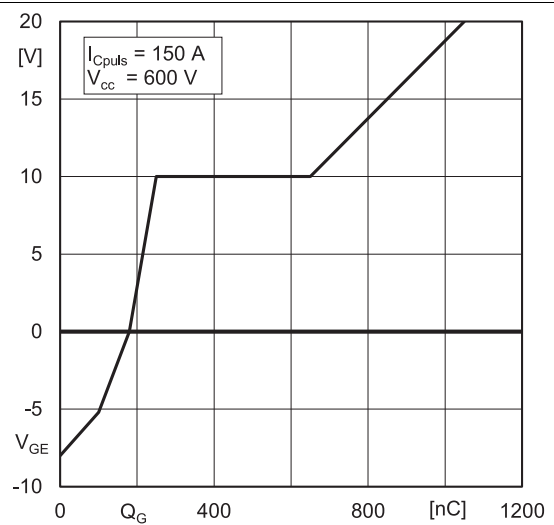

Fig. 6: Typ. IGBT1 gate charge characteristic

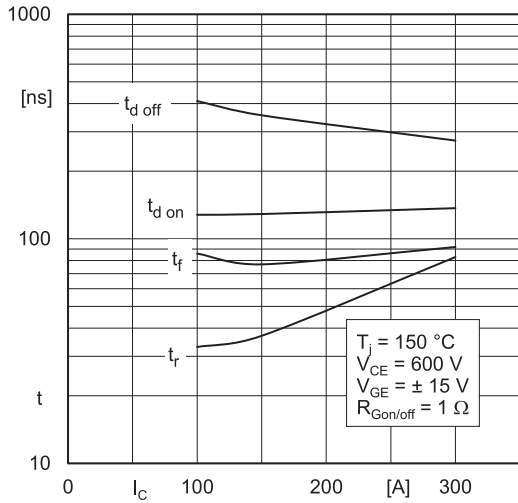

Fig. 7: Typ. IGBT1 switching times vs. I_C

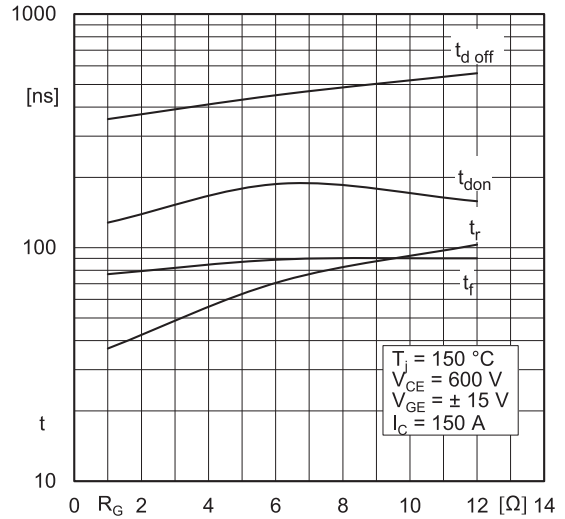

Fig. 8: Typ. IGBT1 switching times vs. gate resistor R_G

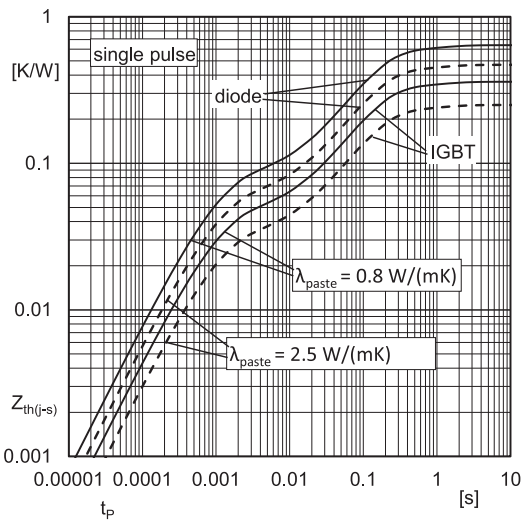

Fig. 9: Transient thermal impedance of IGBT1 & Diode5

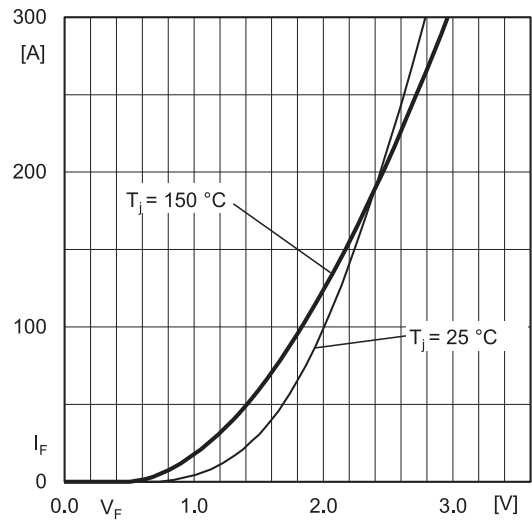

Fig. 10: Typ. Diode5 forward characteristic, incl. $R_{CC+EE'}$

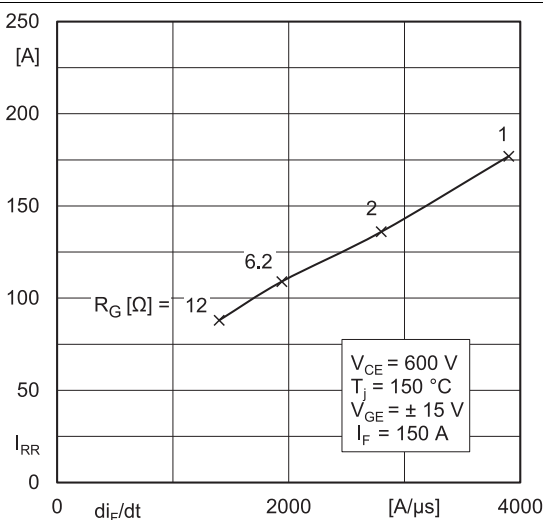

Fig. 11: Typ. Diode5 peak reverse recovery current

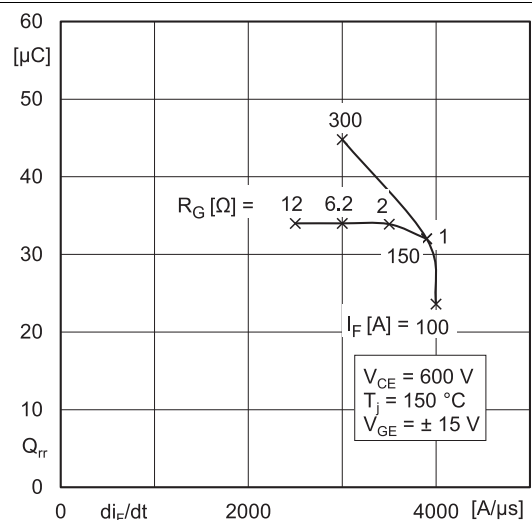
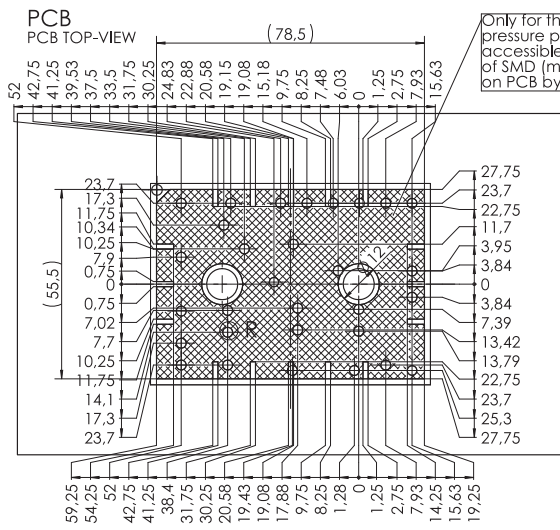
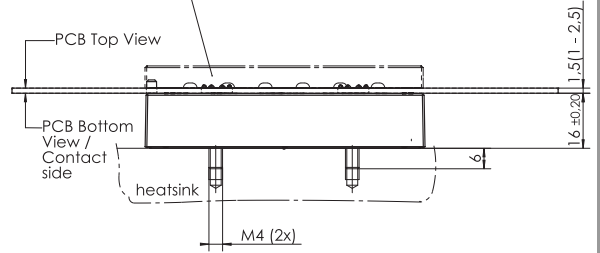

Fig. 12: Typ. Diode5 recovery charge

SKiiP 39MLI12T4V1



standard pressure part not part of MiniSKiiP, must be ordered separately



PCB BOTTOM VIEW CONTACT-SIDE ISO 2768-f

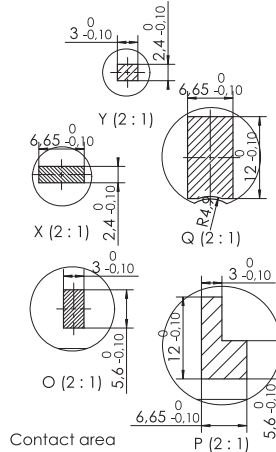
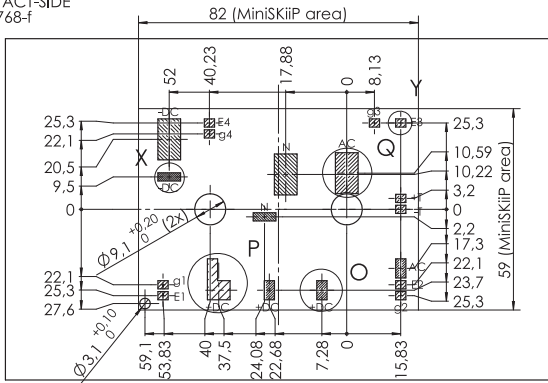

for mounting please follow the assembly instruction

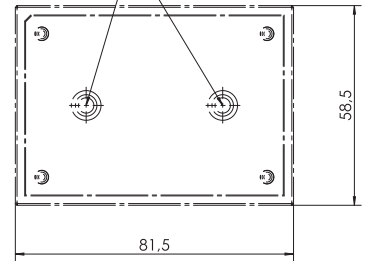

pinout, dimensions

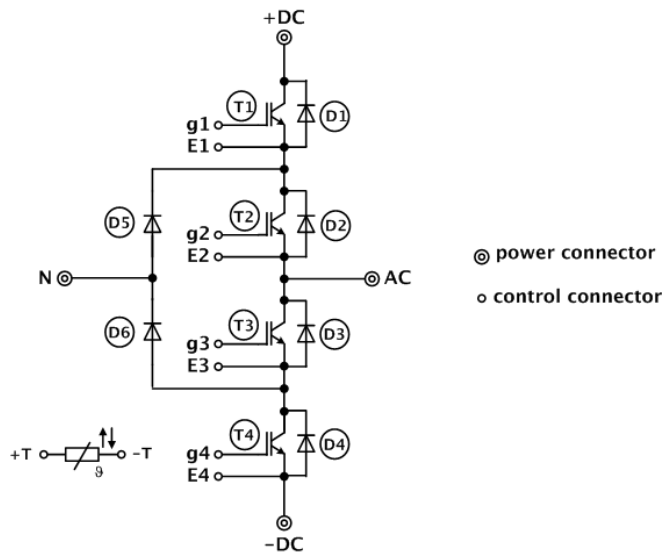

pinout

This is an electrostatic discharge sensitive device (ESDS), international standard IEC 60747-1, chapter IX.

***IMPORTANT INFORMATION AND WARNINGS**

The specifications of SEMIKRON products may not be considered as guarantee or assurance of product characteristics ("Beschaffenheitsgarantie"). The specifications of SEMIKRON products describe only the usual characteristics of products to be expected in typical applications, which may still vary depending on the specific application. Therefore, products must be tested for the respective application in advance. Application adjustments may be necessary. The user of SEMIKRON products is responsible for the safety of their applications embedding SEMIKRON products and must take adequate safety measures to prevent the applications from causing a physical injury, fire or other problem if any of SEMIKRON products become faulty. The user is responsible to make sure that the application design is compliant with all applicable laws, regulations, norms and standards. Except as otherwise explicitly approved by SEMIKRON in a written document signed by authorized representatives of SEMIKRON, SEMIKRON products may not be used in any applications where a failure of the product or any consequences of the use thereof can reasonably be expected to result in personal injury. No representation or warranty is given and no liability is assumed with respect to the accuracy, completeness and/or use of any information herein, including without limitation, warranties of non-infringement of intellectual property rights of any third party. SEMIKRON does not assume any liability arising out of the applications or use of any product; neither does it convey any license under its patent rights, copyrights, trade secrets or other intellectual property rights, nor the rights of others. SEMIKRON makes no representation or warranty of non-infringement or alleged non-infringement of intellectual property rights of any third party which may arise from applications. Due to technical requirements our products may contain dangerous substances. For information on the types in question please contact the nearest SEMIKRON sales office. This document supersedes and replaces all information previously supplied and may be superseded by updates. SEMIKRON reserves the right to make changes.