

## N-Channel Power MOSFET

### General Features

- $V_{DS} = 30V, I_D = 150A$   
 $R_{DS(ON)} < 1.6 m\Omega @ V_{GS}=10V$   
 $R_{DS(ON)} < 2.4 m\Omega @ V_{GS}=4.5V$
- Improved dv/dt capability
- High density cell design for ultra low Rdson
- Good stability and uniformity with high EAs
- Excellent package for good heat dissipation

### Applications

- Power switching application
- MB/VGA/Server Vcore
- POL Applications

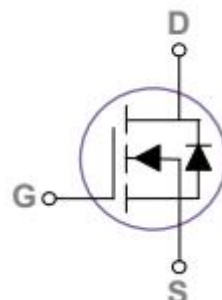

Schematic diagram



DFN5X6-8L top view

### Absolute Maximum Ratings ( $T_C=25^\circ C$ unless otherwise noted)

Parameter	Symbol	Limit	Unit
Drain-Source Voltage	$V_{DS}$	30	V
Gate-Source Voltage	$V_{GS}$	$\pm 20$	V
Drain Current-Continuous ( $T_C=25^\circ C$ )	$I_D(25^\circ C)$	150	A
Drain Current-Continuous ( $T_C=100^\circ C$ )	$I_D(100^\circ C)$	82	A
Pulsed Drain Current	$I_{DM}$	520	A
Maximum Power Dissipation	$P_D$	166	W
Derating factor		1.33	W/ $^\circ C$
Operating Junction and Storage Temperature Range	$T_J, T_{STG}$	-55 To 175	$^\circ C$

**Thermal Characteristic**

Thermal Resistance, Junction-to-Case <sup>(Note 2)</sup>	$R_{\theta JC}$	1.5	°C/W
--	-----------------	-----	------

**Electrical Characteristics ( $T_C=25^\circ\text{C}$  unless otherwise noted)**

Parameter	Symbol	Condition	Min	Typ	Max	Unit
<b>Off Characteristics</b>						
Drain-Source Breakdown Voltage	$BV_{DSS}$	$V_{GS}=0V, I_D=250\mu A$	30	-	-	V
Drain-Source Leakage Current	$I_{DSS}$	$V_{DS}=27V, V_{GS}=0V, T_J=25^\circ\text{C}$	-	-	1	$\mu A$
		$V_{DS}=24V, V_{GS}=0V, T_J=85^\circ\text{C}$	-	-	10	$\mu A$
Gate-Body Leakage Current	$I_{GSS}$	$V_{GS}=\pm 20V, V_{DS}=0V$	-	-	$\pm 100$	nA
<b>On Characteristics (Note 3)</b>						
Gate Threshold Voltage	$V_{GS(th)}$	$V_{DS}=V_{GS}, I_D=250\mu A$	1.0	1.6	2.5	V
Drain-Source On-State Resistance	$R_{DS(on)}$	$V_{GS}=10V, I_D=30A$	-	1.2	1.6	m $\Omega$
		$V_{GS}=4.5V, I_D=15A$	-	1.8	2.4	
Forward Transconductance	$g_{FS}$	$V_{DS}=10V, I_D=15A$	-	30	-	S
<b>Dynamic Characteristics (Note 4)</b>						
Input Capacitance	$C_{iss}$	$V_{DS}=25V, V_{GS}=0V,$ $F=1.0\text{MHz}$	-	7720	11000	PF
Output Capacitance	$C_{oss}$		-	945	1400	PF
Reverse Transfer Capacitance	$C_{rss}$		-	435	650	PF
<b>Switching Characteristics (Note 4)</b>						
Turn-on Delay Time	$t_{d(on)}$	$V_{DD}=15V, I_D=1A$ $V_{GS}=10V, R_G=3.3\Omega$	-	28	56	nS
Turn-on Rise Time	$t_r$		-	45	90	nS
Turn-Off Delay Time	$t_{d(off)}$		-	105	200	nS
Turn-Off Fall Time	$t_f$		-	40	80	nS
Total Gate Charge	$Q_g$	$V_{DS}=15V, I_D=10A,$ $V_{GS}=4.5V$	-	65	120	nC
Gate-Source Charge	$Q_{gs}$		-	16	30	nC
Gate-Drain Charge	$Q_{gd}$		-	21	40	nC
<b>Drain-Source Diode Characteristics</b>						
Diode Forward Voltage <sup>(Note 3)</sup>	$V_{SD}$	$V_{GS}=0V, I_S=1A, T_J=25^\circ\text{C}$	-	-	1.0	V
Continuous Source Current <sup>(Note 2)</sup>	$I_S$	$V_G=V_D=0V, \text{Force Current}$	-	-	130	A
Pulsed Source Current <sup>(Note 3)</sup>	$I_{Sm}$		-	-	260	A

**Notes:**

1. Repetitive Rating: Pulse width limited by maximum junction temperature.
2. Surface Mounted on FR4 Board,  $t \leq 10$  sec.
3. Pulse Test: Pulse Width  $\leq 300\mu s$ , Duty Cycle  $\leq 2\%$ .
4. Guaranteed by design, not subject to production

## Typical Electrical and Thermal Characteristics (Curves)

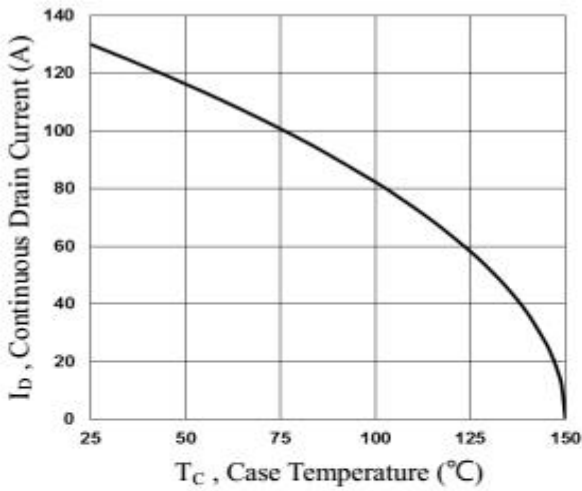

**Fig.1 Continuous Drain Current vs.  $T_c$**

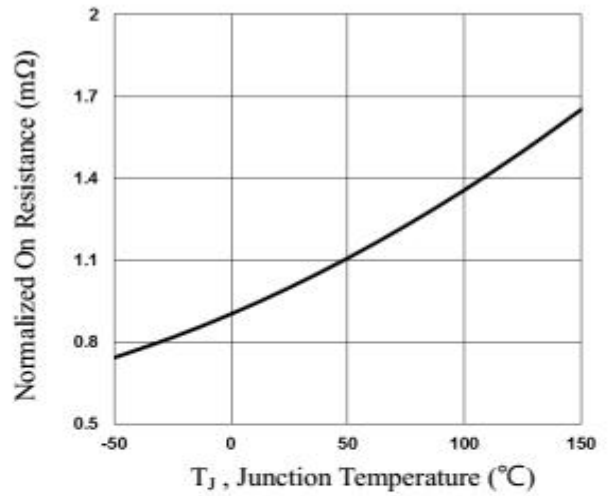

**Fig.2 Normalized  $R_{DS(ON)}$  vs.  $T_j$**

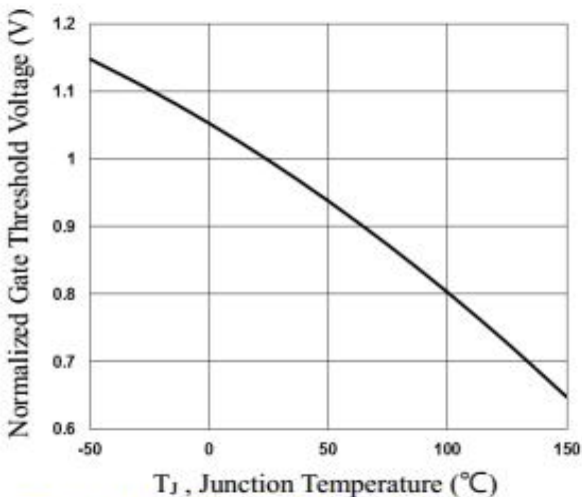

**Fig.3 Normalized  $V_{th}$  vs.  $T_j$**

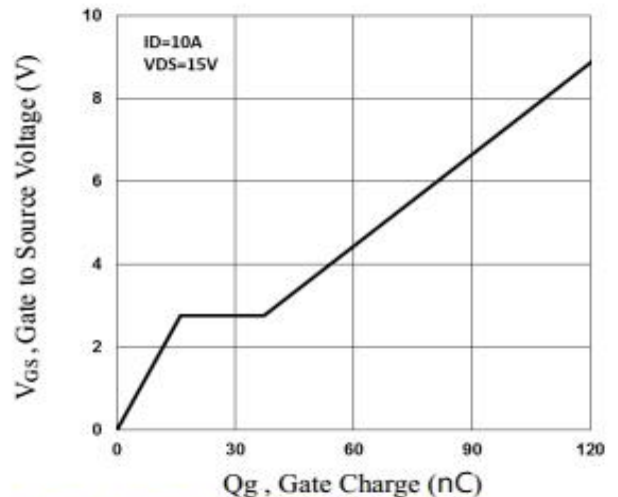

**Fig.4 Gate Charge Waveform**

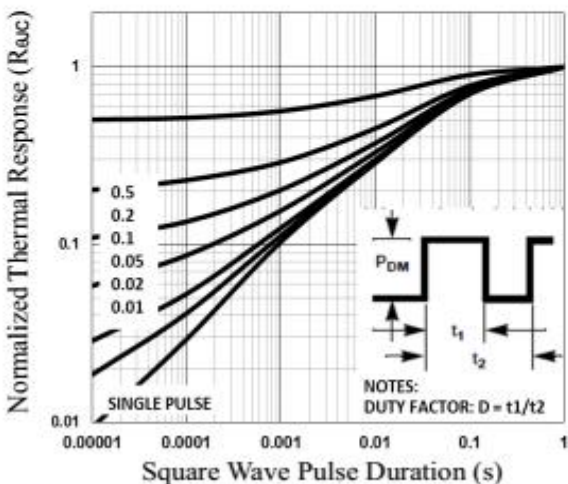

**Fig.5 Normalized Transient Impedance**

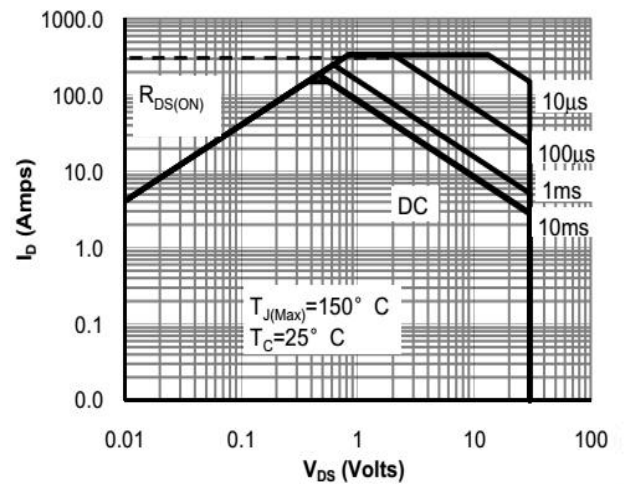

**Fig.6 Maximum Safe Operation Area**

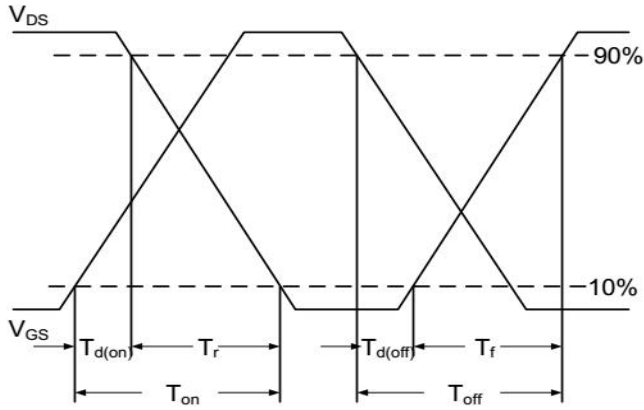

**Fig.7 Switching Time Waveform**

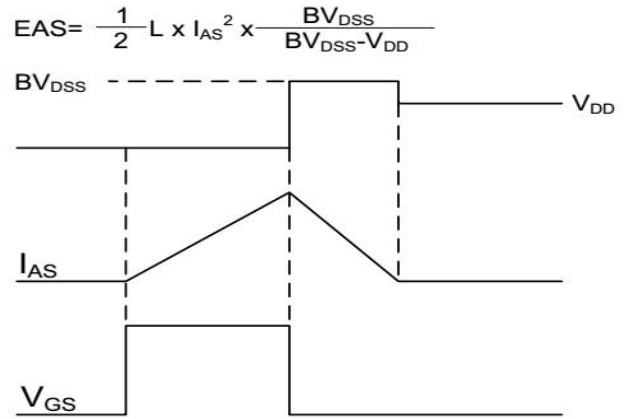

**Fig.8 EAS Waveform**

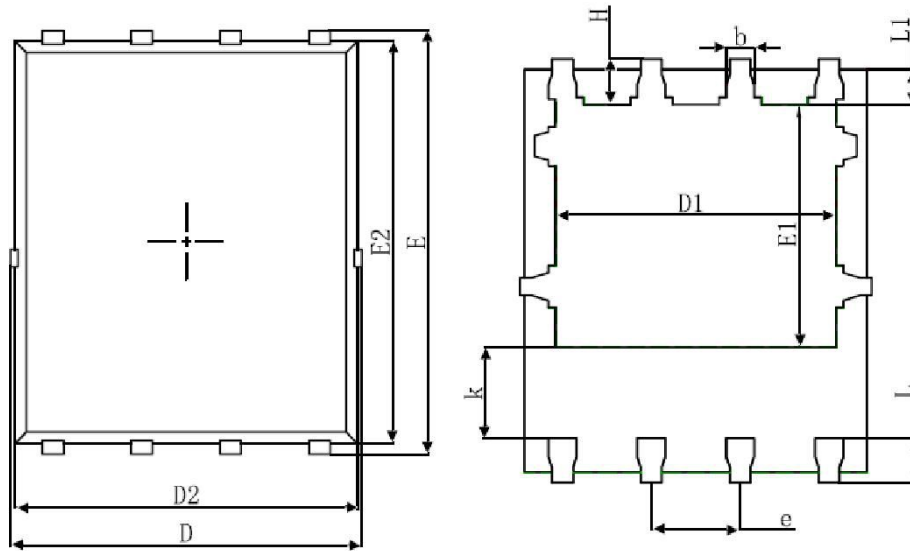
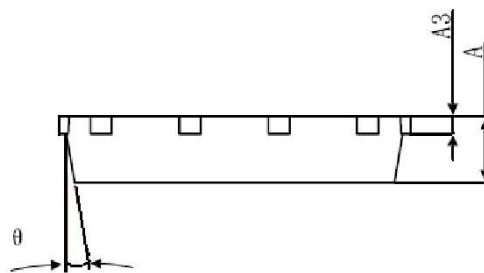
**DFN5X6-8L Package Information**

Top View
Bottom View

Side View

Symbol	Dimensions In Millimeters		Dimensions In Inches	
	Min.	Max.	Min.	Max.
A	0.900	1.000	0.035	0.039
A3	0.254REF.		0.010REF.	
D	4.944	5.096	0.195	0.201
E	5.974	6.126	0.235	0.241
D1	3.910	4.110	0.154	0.162
E1	3.375	3.575	0.133	0.141
D2	4.824	4.976	0.190	0.196
E2	5.674	5.826	0.223	0.229
k	1.190	1.390	0.047	0.055
b	0.350	0.450	0.014	0.018
e	1.270TYP.		0.050TYP.	
L	0.559	0.711	0.022	0.028
L1	0.424	0.576	0.017	0.023
H	0.574	0.726	0.023	0.029
θ	8°	12°	8°	12°