

Schottky Barrier Rectifiers

SL32A--SL34A

Features

- Metal silicon junction, majority carrier conduction
- High surge capability
- High temperature soldering guaranteed:
260°C/10 seconds
- High current capability, low forward voltage drop
- Guarding for over voltage protection
- RoHS Compliant



Mechanical Data

- Case: SMA molded plastic
- Molding compound, UL flammability classification rating 94V-0
- Terminals: Matte tin plated leads, solderable per J-STD-002 and JESD22-B102
- Polarity: Color band denotes cathode end

Maximum Ratings (@T_A = 25°C unless otherwise specified)

Characteristic	Symbol	SL32A	SL33A	SL34A	Units
Peak repetitive reverse voltage	V _{RRM}	20	30	40	V
RMS reverse voltage	V _{RMS}	14	21	28	V
DC blocking voltage	V _{DC}	20	30	40	V
Maximum average forward output current	I _{F(AV)}	3.0			A
Peak forward surge current, 8.3ms single half-sine-wave	I _{FSM}	80			A

Thermal Characteristics

Parameter	Symbol	SL32A	SL33A	SL34A	Units
Typical thermal resistance (Note 1)	R _{θJA}	70			°C/W
	R _{θJC}	25			
	R _{θJL}	30			
Operating junction temperature range	T _J	- 55 ---- + 125			°C
Storage temperature range	T _{STG}	- 55 ---- + 150			°C

Note:

1. Device mounted on PCB with 10 mm x 20 mm x 0.1mm copper pad areas

Schottky Barrier Rectifiers

SL32A--SL34A

Electrical Characteristics (@ $T_A = 25^\circ\text{C}$ unless otherwise specified)

Parameter	Symbol	Test conditions		Typ.	Max.	Units
Maximum instantaneous forward voltage(Note 1)	V_F	$I_F=3.0\text{A}$	@ $T_A=25^\circ\text{C}$	--	0.45	V
Maximum Reverse current (Note 2)	I_R	Rated V_R ,	@ $T_J=25^\circ\text{C}$	--	500	μA
			@ $T_J=100^\circ\text{C}$	--	40	m A

Note:

- 1.Pulse test: 300us pulse width, 1 % duty cycle
- 2.Pulse test: Pulse width 40ms

Schottky Barrier Rectifiers

SL32A--SL34A

Ratings and Characteristic Curves ($T_A=25^\circ\text{C}$ unless otherwise noted)

Fig.1-Forward Current Derating Curve

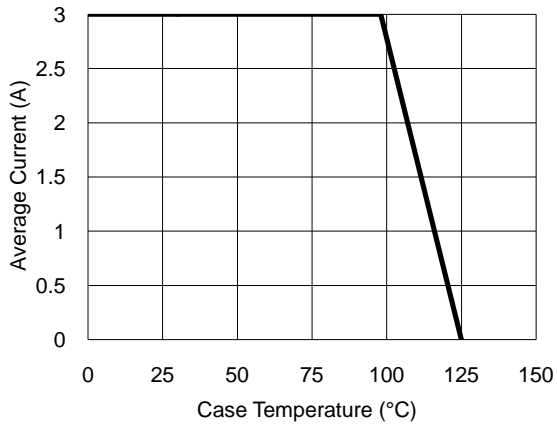

Fig.2- Surge Current Derating Curve

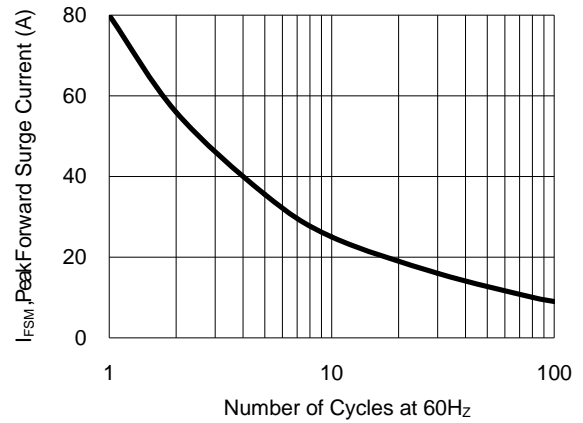

Fig.3- Typical Forward Voltage Characteristic

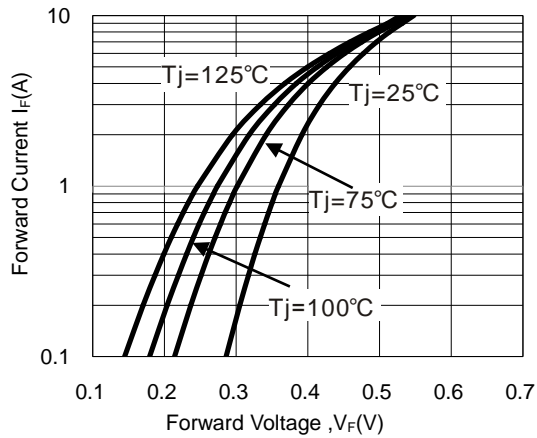
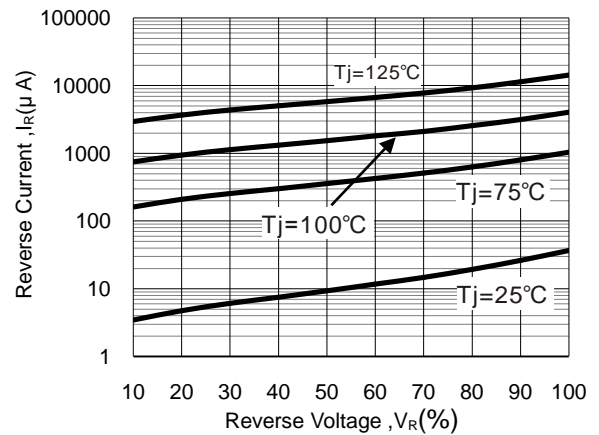

Fig.4- Typical Reverse Characteristic



Schottky Barrier Rectifiers

SL32A--SL34A

Package Outline Dimensions(unit:mm)

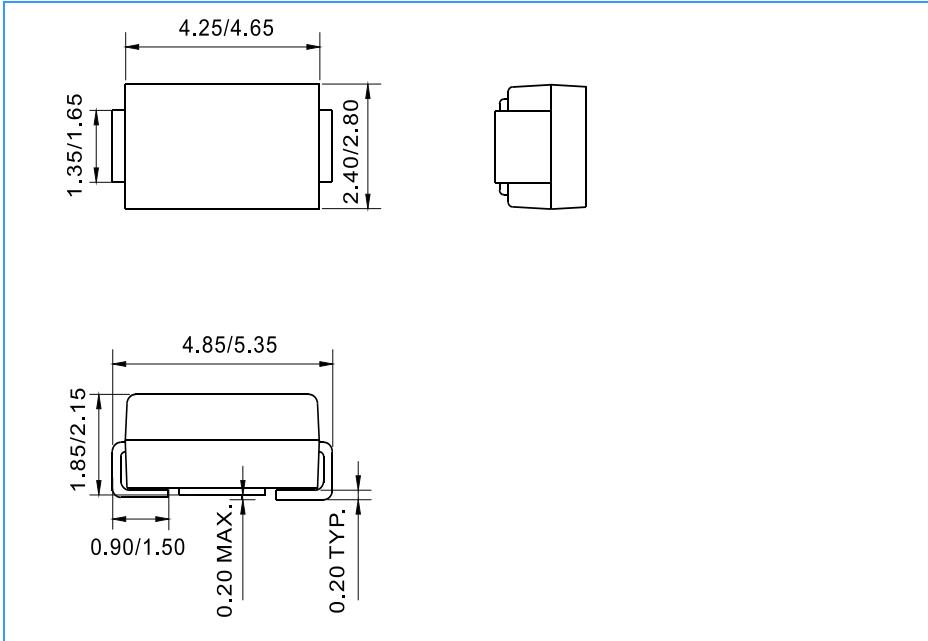

Mounting Pad Layout(unit:mm)

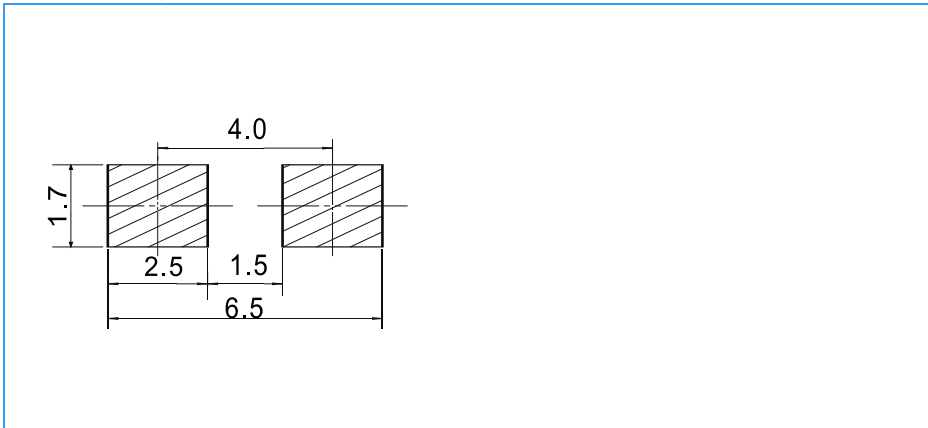

Ordering Information

Part No.	Marking	Package	Shipping
SL32A	SL32A	SMA	5000/Tape&Reel
SL33A	SL33A	SMA	5000/Tape&Reel
SL34A	SL34A	SMA	5000/Tape&Reel