



# Obsolescence Notice

This product is obsolete.

This information is available for your convenience only.

For more information on Zarlink's obsolete products and replacement product lists, please visit [http://products.zarlink.com/obsolete\\_products/](http://products.zarlink.com/obsolete_products/)

***THIS DOCUMENT IS FOR MAINTENANCE  
PURPOSES ONLY AND IS NOT  
RECOMMENDED FOR NEW DESIGNS***



# SL6654

## LOWER POWER IF/AF CIRCUIT (WITH RSSI) FOR FM CELLULAR RADIO

The SL6654 is a complete single chip mixer/oscillator, IF amplifier and detector for FM cellular radio, cordless telephones and low power radio applications. It features an exceptionally stable RSSI (Received Signal Strength Indicator) output using a unique system of detection. Supply current is less than 2mA from a supply voltage in the range 2.5V to 7.5V.

### FEATURES

- Low Power Consumption (1.5mA)
- Single Chip Solution
- Guaranteed 100MHz Operation
- Exceptionally Stable RSSI

### APPLICATIONS

- Cellular Radio Telephones
- Cordless Telephones

### QUICK REFERENCE DATA

- Supply Voltage 2.5V to 7.5V
- Sensitivity 3µV
- Co-Channel Rejection 7dB

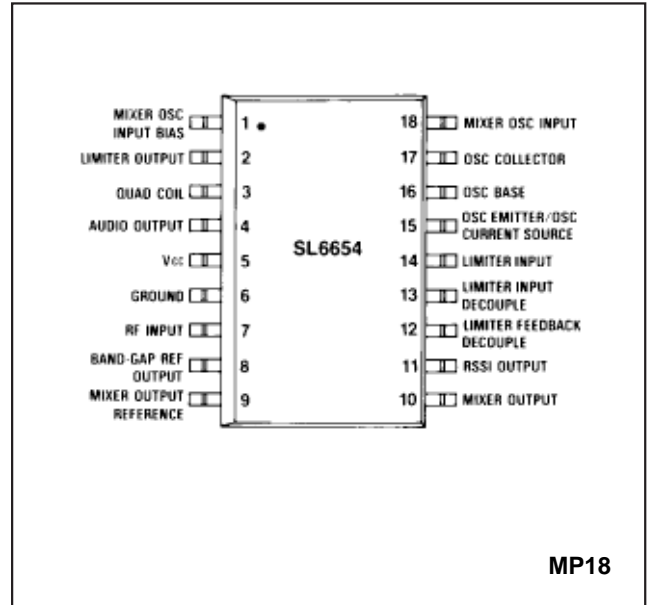

Fig. 1 Pin connections (top view)

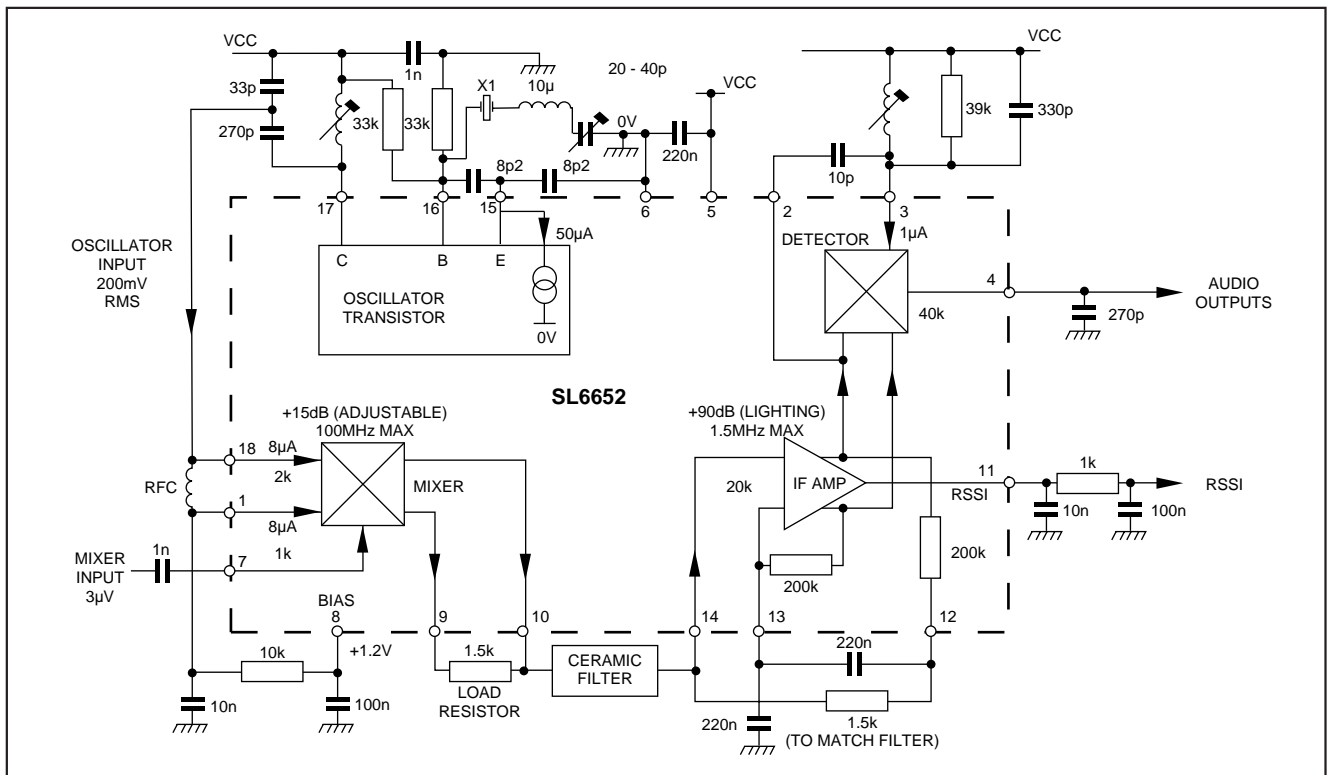

Fig. 2 block diagram

**SL6654**

**ABSOLUTE MAXIMUM RATINGS**

Supply voltage	8V
Storage temperature	-55°C to +150°C
Operating temperature	-55°C to +125°C
Mixer input	1V rms

**ELECTRICAL CHARACTERISTICS**

Test conditions (unless otherwise stated):

$V_{CC} = 2.5V$  to  $7.5V$ ,  $T_{amb} = -30°C$  to  $+85°C$ ,  $IF = 455kHz$ ,  $RF = 50MHz$ , Quad Coil Working  $Q = 30$

Characteristics	Value			Units	Conditions
	Min.	Typ.	Max.		
<b>Overall</b>					
Supply current		1.5	20	mA	
Sensitivity		5	10	$\mu V$	20dB SINAD
		3		$\mu V$	12dB SINAD
AM rejection		40		dB	RF input <500 $\mu V$
$V_{bias}$	1.0	1.2	1.4	V	$T_{amb} = 25°C$
Co-channel rejection		7		dB	See Note 2
<b>Mixer</b>					
RF input impedance		1		kohm	
OSC input impedance		2		kohm	
OSC input bias		5		$\mu A$	At $V_{bias}$
Mixer gain		15		dB	Rload = 1.5k
3rd order input intercept		-10		dBm	
OSC input level	180		300	mV	
OSC frequency	100			MHz	
<b>Oscillator</b>					
Current sink	40		70	$\mu A$	$T_{amb} = 25°C$
$H_{fe}$	30				40 ... 70 $\mu A$
$f_T$		500		MHz	40 ... 70 $\mu A$
<b>IF Amplifier</b>					
Gain		90		dB	
Frequency	455	1500		kHz	
Diff. input impedance		20		kohm	
<b>Detector</b>					
Audio output level	75		125	mV	} 5mV into pin 14
Ultimate S/N ratio		60		dB	
THD		0.5	5	%	
Output impedance		40		kohm	
Inter-output isolation		65		dB	1kHz
<b>RSSI Output (<math>T_{amb} = +25°C</math>)</b>					
Output current			20	$\mu A$	No input pin 14
Output current	50		80	$\mu A$	Pin 14 = 2.5mV
Current change	0.9	1.22	1.5	$\mu A/dB$	See Note 1
Linear dynamic range	70			dB	See Note 1

**NOTES**

1. The RSSI output is 100% dynamically tested at 5V and +20° C over a 70dB range. First the input to pin 14 is set to 2.5mV and the RSSI current recorded Then for each step of 10dB from -40 to +30dB the current is measured again. The current change in each step must meet the specified figure for current change. The RSSI output is guaranteed monotonic and free from discontinuities over this range.

2. Co-channel rejection is measured by applying a 3kHz deviation, 1 kHz modulated signal at an input level to give a 20dB SINAD ratio. Then a 3kHz deviation, 400Hz modulated signal on the same frequency is also applied and its level increased to degrade the SINAD to 14dB.

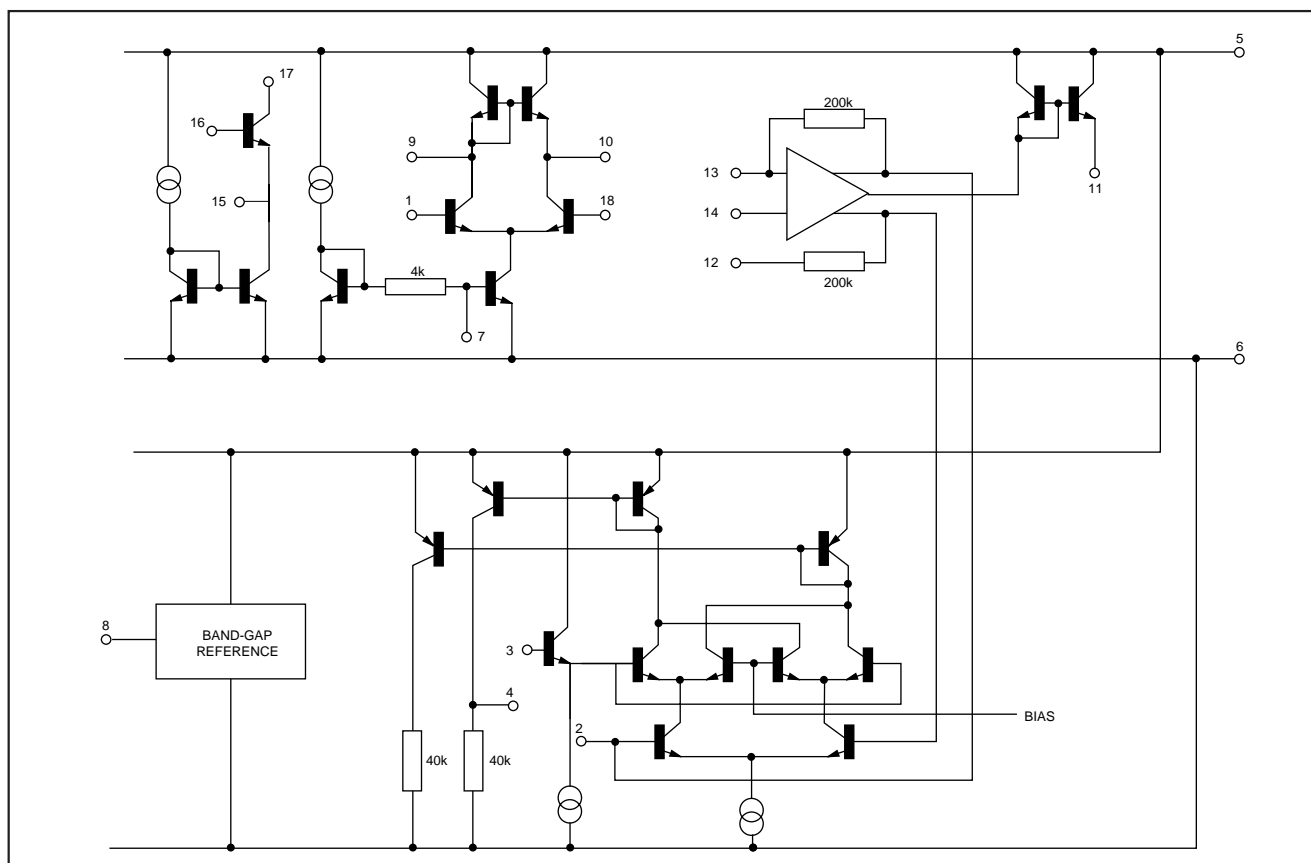

Fig. 3 Internal schematic

## GENERAL DESCRIPTION

The SL6654 is a very low power, high performance integrated circuit intended for IF amplification and demodulation in FM radio receivers. It comprises:

- A mixer stage for use up to 100MHz
- An uncommitted transistor for use as an oscillator
- A current sink for biasing this transistor
- A limiting amplifier operating up to 1.5MHz
- A quadrature detector with differential AF output
- An RSSI (Received Signal Strength Indicator) output

### Mixer

The mixer is single balanced with an active load. Gain is set externally by the load resistor although the value is normally determined by that required for matching into the ceramic filter. It is possible to use a tuned circuit but an increase in mixer gain will result in a corresponding reduction of the mixer input intercept point.

The RF input is a diode-biased transistor with a bias current of typically 300 $\mu$ A. The oscillator input is differential but would normally be driven single-ended. Special care should be taken to avoid accidental overload of the oscillator input.

### Oscillator

The oscillator consists of an uncommitted transistor and a separate current sink. The user should ensure that the design

of oscillator is suitable for the type of crystal and frequency required; it may not always be adequate to duplicate the design shown in this data sheet.

### IF amplifier

The limiting amplifier is capable of operation to at least 1 MHz and the input impedance is set by an external resistor to match the ceramic filter. Because of the high gain, pins 12 and 13 must be adequately bypassed.

### Detector

A conventional quadrature detector is fed internally from the IF amplifier; the quadrature input is fed externally using an appropriate capacitor and phase shift network. A differential output is provided to feed a comparator for digital use, although it can also be used to provide AFC.

### RSSI output

The RSSI output is a current source with value proportional to the logarithm of the IF input signal amplitude. There is a small residual current due to noise within the amplifier (and mixer) but beyond this point there is a measured and guaranteed 70dB dynamic range. The typical range extends to 92dB, independent of frequency, and with exceptionally good temperature and supply voltage stability.

# SL6654

## Supply voltage

The SL6652 will operate reliably from 2.5V to 7.5V. The supply line must be decoupled with 470nF using short leads.

## Detector

The internal band gap reference must be externally decoupled. It can be used as an external reference but must not be loaded heavily; the output impedance is typically 14 ohms.

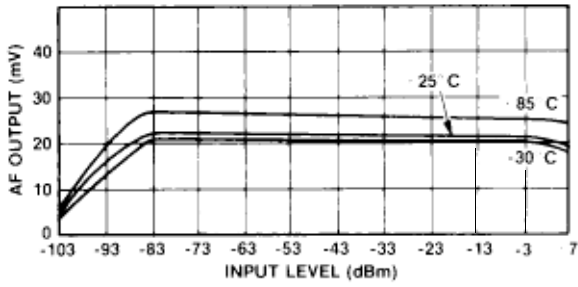

Fig. 4 Audio output vs input and temperature at 2.5V

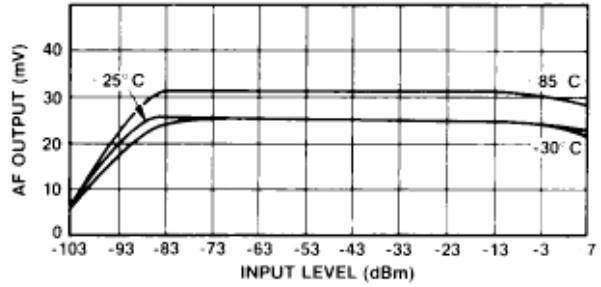

Fig. 5 Audio output vs input and temperature at 5.0V

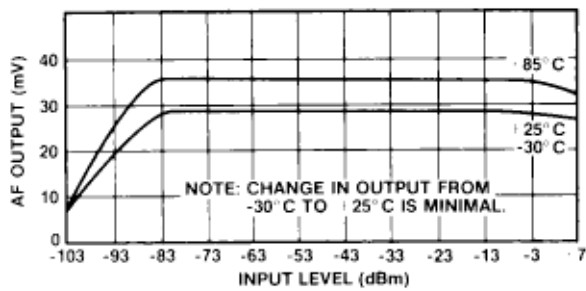

Fig. 6 Audio output vs input and temperature at +7.5V

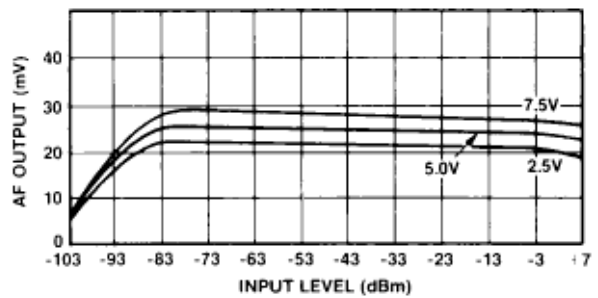

Fig. 7 Audio output vs input and supply voltage at +25°C

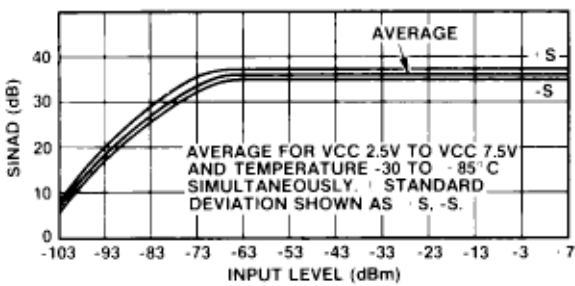

Fig. 8 SINAD and input level

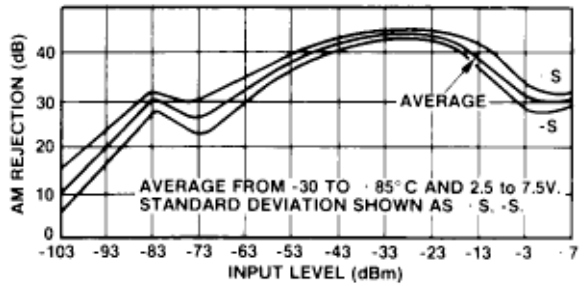

Fig. 9 AM rejection and input level

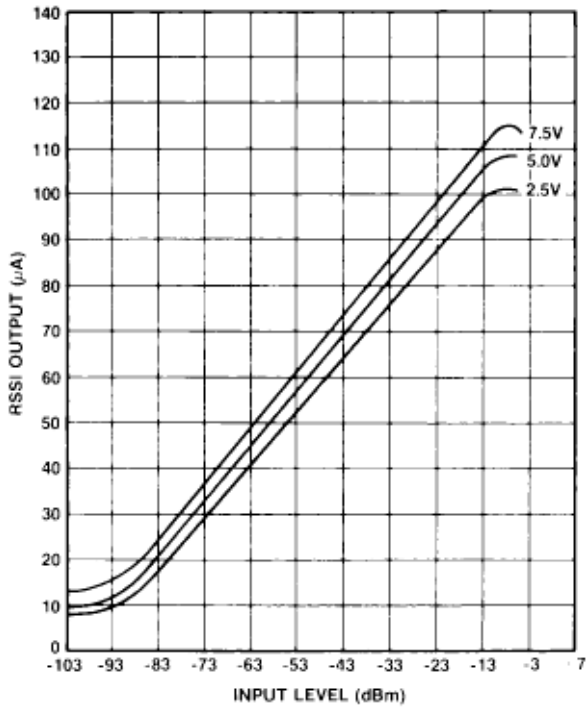

Fig. 10 RSSI output vs input and supply voltage ( $T_{amb} = 20^{\circ}C$ )

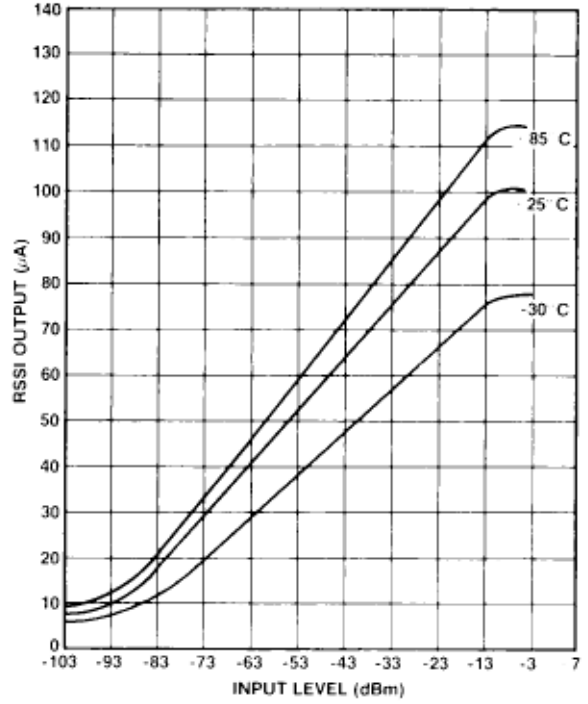

Fig. 11 RSSI output vs input level and temperature ( $V_{CC} = 2.5V$ )

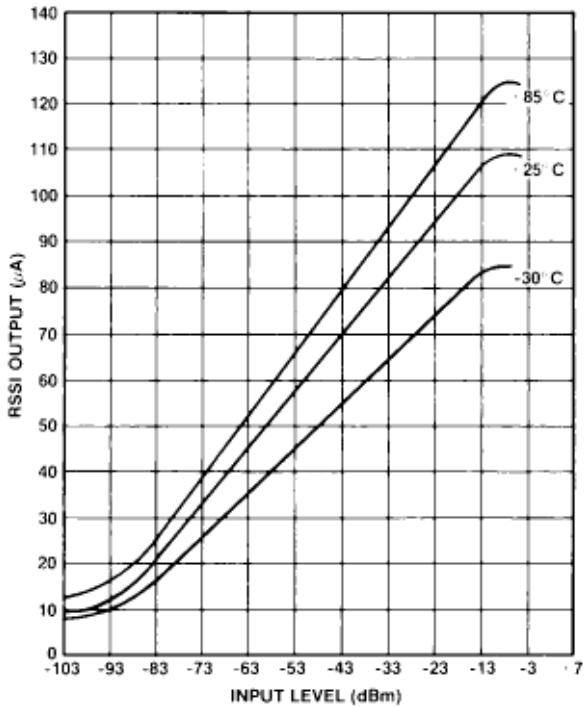

Fig. 12 RSSI output vs input level and temperature ( $T_{CC} = 5V$ )

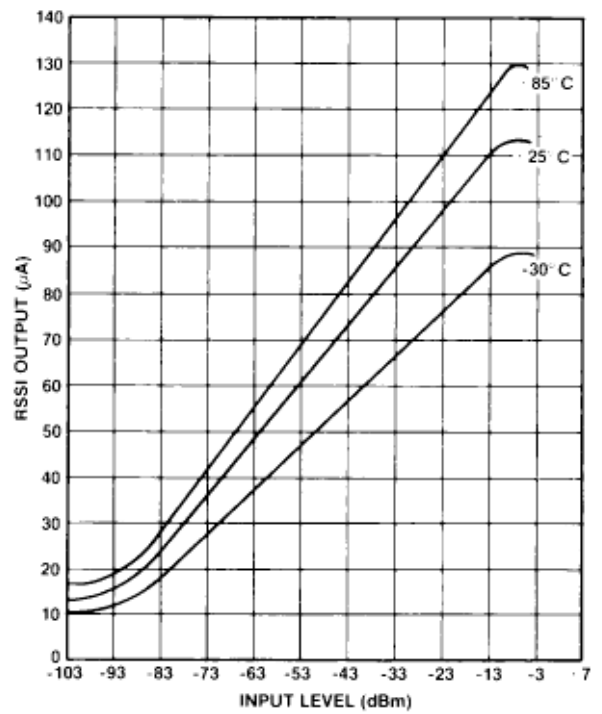

Fig. 13 RSSI output vs input level and temperature ( $V_{CC} = 7.5V$ )

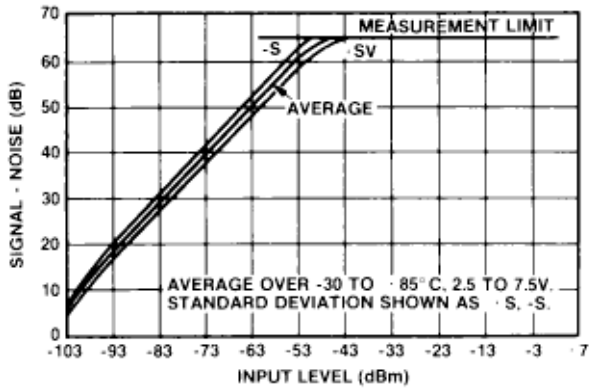

Fig. 14 Signal + noise to noise ratio vs input level

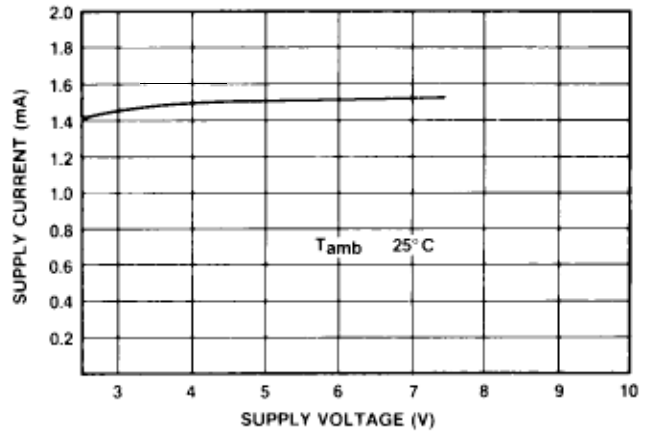

Fig. 15 Supply current vs supply voltage

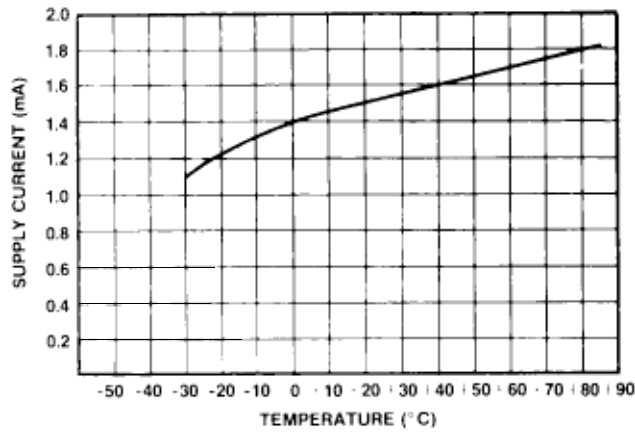

Fig. 16 Supply current vs temperature ( $V_{cc} = 5V$ )





## HEADQUARTERS OPERATIONS

**GEC PLESSEY SEMICONDUCTORS**

Cheney Manor, Swindon,  
Wiltshire SN2 2QW, United Kingdom.  
Tel: (0793) 518000  
Fax: (0793) 518411

**GEC PLESSEY SEMICONDUCTORS**

P.O. Box 660017  
1500 Green Hills Road,  
Scotts Valley, California 95067-0017,  
United States of America.  
Tel: (408) 438 2900  
Fax: (408) 438 5576

## CUSTOMER SERVICE CENTRES

- **FRANCE & BENELUX** Les Ulis Cedex Tel: (1) 64 46 23 45 Tx: 602858F  
Fax : (1) 64 46 06 07
- **GERMANY** Munich Tel: (089) 3609 06-0 Tx: 523980 Fax : (089) 3609 06-55
- **ITALY** Milan Tel: (02) 66040867 Fax: (02) 66040993
- **JAPAN** Tokyo Tel: (03) 3296-0281 Fax: (03) 3296-0228
- **NORTH AMERICA Integrated Circuits and Microwave Products** Scotts Valley, USA  
Tel (408) 438 2900 Fax: (408) 438 7023.  
**Hybrid Products**, Farmingdale, USA Tel (516) 293 8686  
Fax: (516) 293 0061.
- **SOUTH EAST ASIA** Singapore Tel: (65) 3827708 Fax: (65) 3828872
- **SWEDEN** Stockholm, Tel: 46 8 702 97 70 Fax: 46 8 640 47 36
- **UNITED KINGDOM & SCANDINAVIA**  
Swindon Tel: (0793) 518510 Tx: 444410 Fax : (0793) 518582

These are supported by Agents and Distributors in major countries world-wide.

© GEC Plessey Semiconductors 1992 Publication No. DS3286 Issue No. 1.0 May 1992

This publication is issued to provide information only which (unless agreed by the Company in writing) may not be used, applied or reproduced for any purpose nor form part of any order or contract nor to be regarded as a representation relating to the products or services concerned. No warranty or guarantee express or implied is made regarding the capability, performance or suitability of any product or service. The Company reserves the right to alter without prior knowledge the specification, design or price of any product or service. Information concerning possible methods of use is provided as a guide only and does not constitute any guarantee that such methods of use will be satisfactory in a specific piece of equipment. It is the user's responsibility to fully determine the performance and suitability of any equipment using such information and to ensure that any publication or data used is up to date and has not been superseded. These products are not suitable for use in any medical products whose failure to perform may result in significant injury or death to the user. All products and materials are sold and services provided subject to the Company's conditions of sale, which are available on request.



**For more information about all Zarlink products  
visit our Web Site at  
[www.zarlink.com](http://www.zarlink.com)**

Information relating to products and services furnished herein by Zarlink Semiconductor Inc. or its subsidiaries (collectively "Zarlink") is believed to be reliable. However, Zarlink assumes no liability for errors that may appear in this publication, or for liability otherwise arising from the application or use of any such information, product or service or for any infringement of patents or other intellectual property rights owned by third parties which may result from such application or use. Neither the supply of such information or purchase of product or service conveys any license, either express or implied, under patents or other intellectual property rights owned by Zarlink or licensed from third parties by Zarlink, whatsoever. Purchasers of products are also hereby notified that the use of product in certain ways or in combination with Zarlink, or non-Zarlink furnished goods or services may infringe patents or other intellectual property rights owned by Zarlink.

This publication is issued to provide information only and (unless agreed by Zarlink in writing) may not be used, applied or reproduced for any purpose nor form part of any order or contract nor to be regarded as a representation relating to the products or services concerned. The products, their specifications, services and other information appearing in this publication are subject to change by Zarlink without notice. No warranty or guarantee express or implied is made regarding the capability, performance or suitability of any product or service. Information concerning possible methods of use is provided as a guide only and does not constitute any guarantee that such methods of use will be satisfactory in a specific piece of equipment. It is the user's responsibility to fully determine the performance and suitability of any equipment using such information and to ensure that any publication or data used is up to date and has not been superseded. Manufacturing does not necessarily include testing of all functions or parameters. These products are not suitable for use in any medical products whose failure to perform may result in significant injury or death to the user. All products and materials are sold and services provided subject to Zarlink's conditions of sale which are available on request.

Purchase of Zarlink's I<sup>2</sup>C components conveys a licence under the Philips I<sup>2</sup>C Patent rights to use these components in and I<sup>2</sup>C System, provided that the system conforms to the I<sup>2</sup>C Standard Specification as defined by Philips.

Zarlink, ZL and the Zarlink Semiconductor logo are trademarks of Zarlink Semiconductor Inc.

Copyright Zarlink Semiconductor Inc. All Rights Reserved.

**TECHNICAL DOCUMENTATION - NOT FOR RESALE**

---