

## High-Power Density 1W Laser Diode

### Description

The SLD1324ZT is a gain-guided, high-power laser diode with 1W red visible output. The flat package with built-in TE cooler is adopted and fine tuning of wavelength is possible by controlling the laser chip temperature.

### Features

- High power  
Recommended optical power output :1.0W
- Emitting line width :200μm
- Flat package with built-in photodiode, TE cooler and thermistor

### Applications

- Medical use
- Solid state laser excitation

### Structure

AlGaInP quantum well structure laser diode

### Absolute Maximum Ratings (T<sub>th</sub> = 25°C)

- |                                            |                   |            |  |    |
|--------------------------------------------|-------------------|------------|--|----|
| • Optical power output                     | P <sub>O</sub>    | 1.1        |  | W  |
| • Reverse voltage                          | V <sub>R</sub> LD | 2          |  | V  |
|                                            | P <sub>D</sub>    | 15         |  | V  |
| • Operating temperature (T <sub>th</sub> ) | T <sub>opr</sub>  | -10 to +30 |  | °C |
| • Storage temperature                      | T <sub>stg</sub>  | -40 to +85 |  | °C |
| • Operating current of TE cooler           | I <sub>T</sub>    | 4.0        |  | A  |

### Pin Configuration (Top View)

No.	Function	No.	Function
1	T. E. Cooler (negative)	7	LD (cathode)
2	T. E. Cooler (negative)	8	LD (cathode)
3	Thermister	9	PD (cathode)
4	Thermister	10	PD (anode)
5	LD (anode)	11	T. E. Cooler (positive)
6	LD (anode)	12	T. E. Cooler (positive)

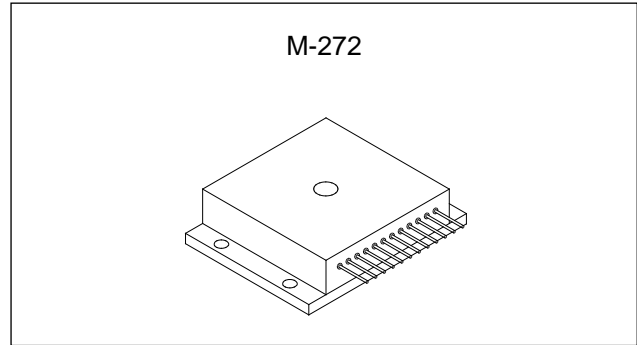

### Equivalent Circuit

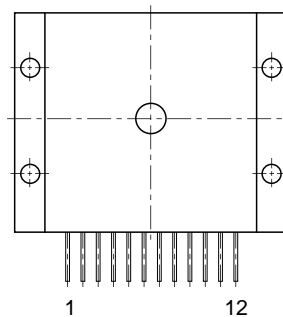
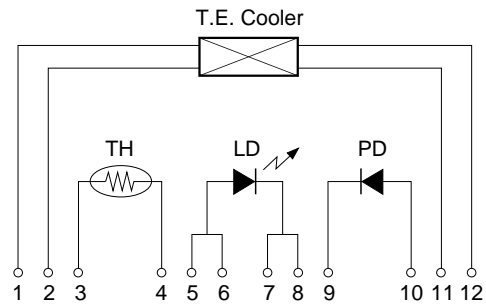

Sony reserves the right to change products and specifications without prior notice. This information does not convey any license by any implication or otherwise under any patents or other right. Application circuits shown, if any, are typical examples illustrating the operation of the devices. Sony cannot assume responsibility for any problems arising out of the use of these circuits.

**Optical and Electrical Characteristics**

(Tth = Thermistor temperature, Tth = 25°C)

Item	Symbol	Conditions	Min.	Typ.	Max.	Unit	
Threshold current	Ith			0.9	1.5	A	
Operating current	Iop	Po = 1.0W		2.1	3.0	A	
Operating voltage	Vop	Po = 1.0W		2.2	3.0	V	
Wavelength	$\lambda$	Po = 1.0W	685	695	705	nm	
Monitor current	Imon	Po = 1.0W, VR = 10V	0.15	1.2	3.0	mA	
Radiation angle (F.W.H.M)	Perpendicular	$\theta_{\perp}$	Po = 1.0W	15	24	35	degree
	Parallel	$\theta_{//}$	Po = 1.0W	4	11	15	degree
Positional accuracy	Position	$\Delta X, \Delta Y$	Po = 1.0W			$\pm 100$	$\mu m$
	Angle	$\Delta \phi_{\perp}$	Po = 1.0W			$\pm 3$	degree
Differential efficiency	$\eta D$	Po = 1.0W	0.3	0.9	1.5	W/A	
Thermistor resistance	Rth	Tth = 25°C		10		k $\Omega$	

**Marking**

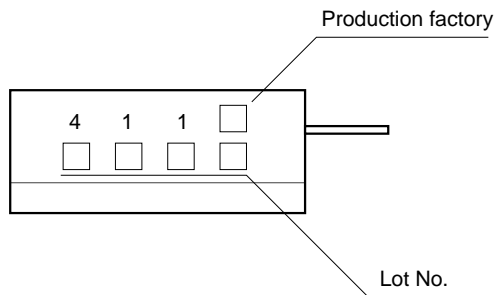

\* Categories are not specified by marking.

**Handling Precautions**

**Eye protection against laser beams**

The optical output of laser diodes ranges from several mW to 3W. However the optical power density of the laser beam at the diode chip reaches 1MW/cm<sup>2</sup>.

Unlike gas lasers, since laser diode beams are divergent, uncollimated laser diode beams are fairly safe at a laser diode. For observing laser beams, ALWAYS use safety goggles that block infrared rays. Usage of IR scopes, IR cameras and fluorescent plates is also recommended for monitoring laser beams safely.

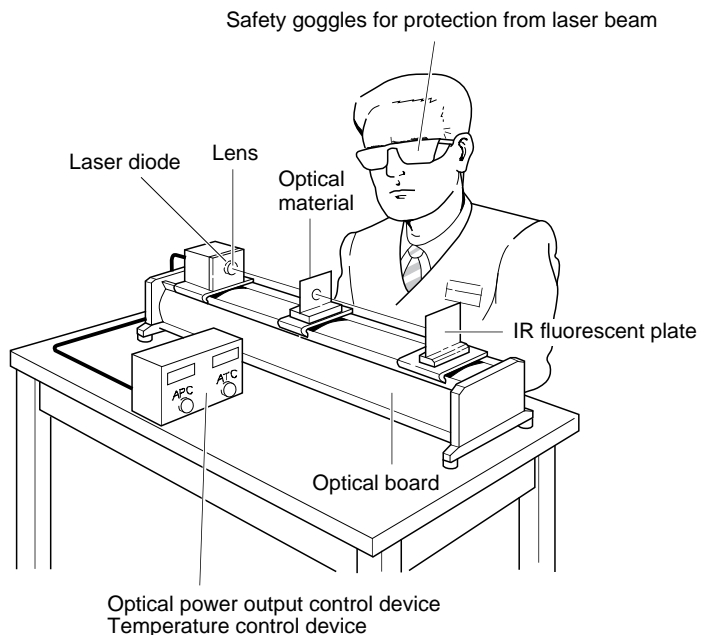

**Optical power output vs. Forward current characteristics**  
**Optical power output vs. Monitor current characteristics**

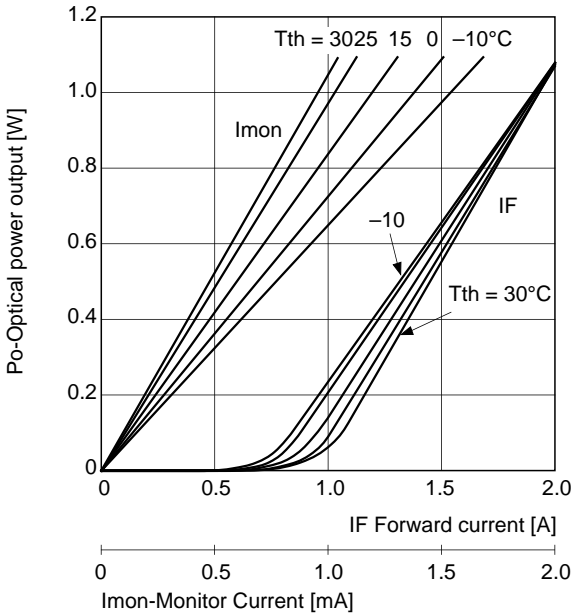

**Threshold current vs. Temperature characteristics**

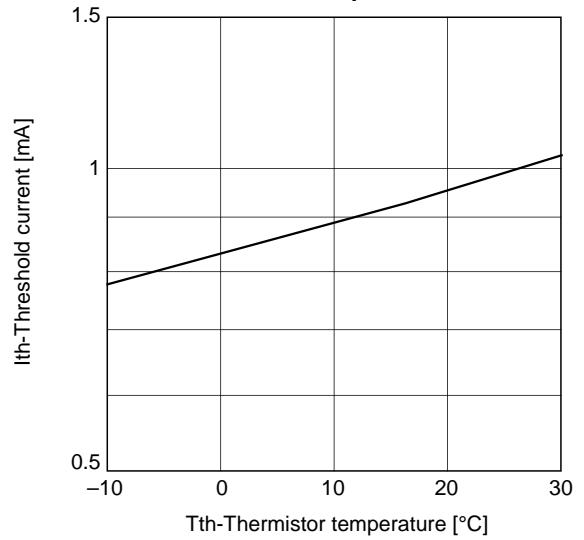

**Slope efficiency vs. Temperature characteristics**

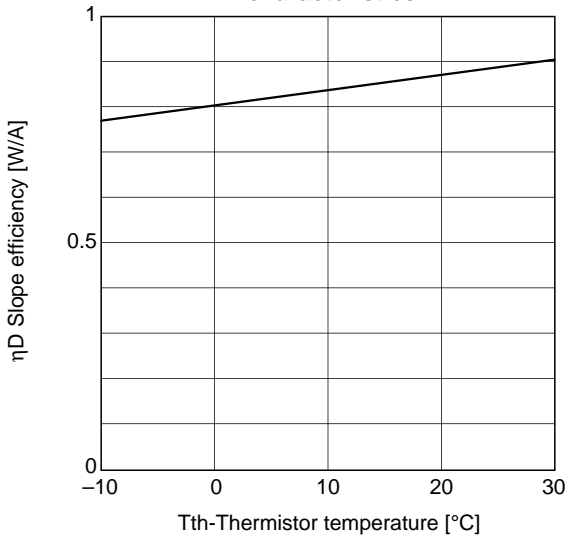

**Temperature dependence of wavelength**

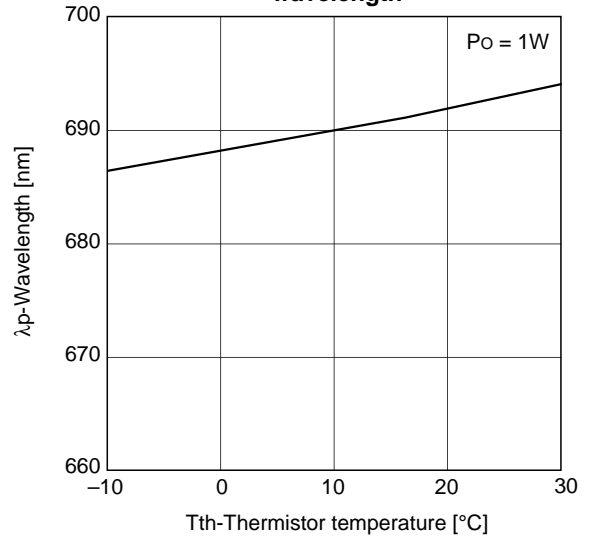

**Power dependence of far field pattern (Perpendicular to junction)**

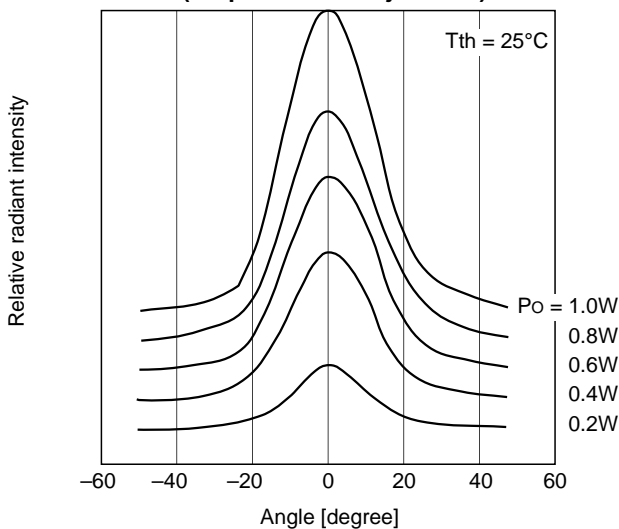

**Power dependence of far field pattern (Parallel to junction)**

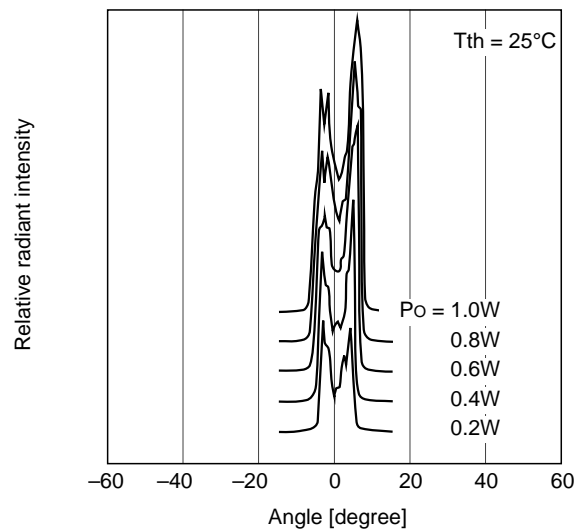

TE cooler characteristics

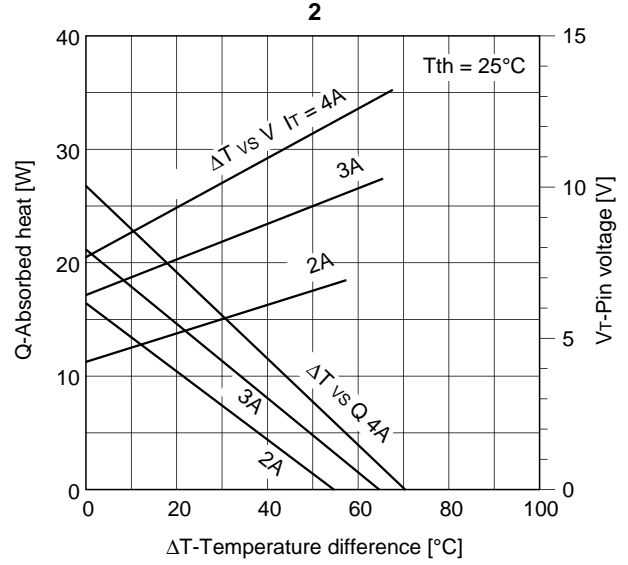
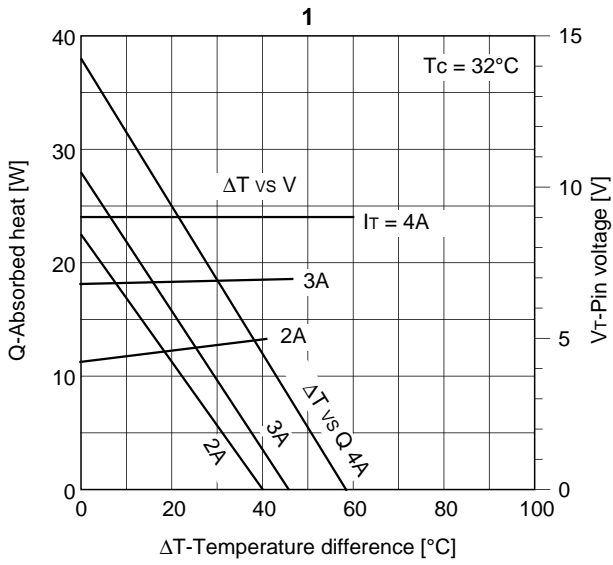

$\Delta T$  :  $T_c - T_{th}$   
 $T_{th}$  : Thermistor temperature  
 $T_c$  : Case temperature

Thermistor characteristics

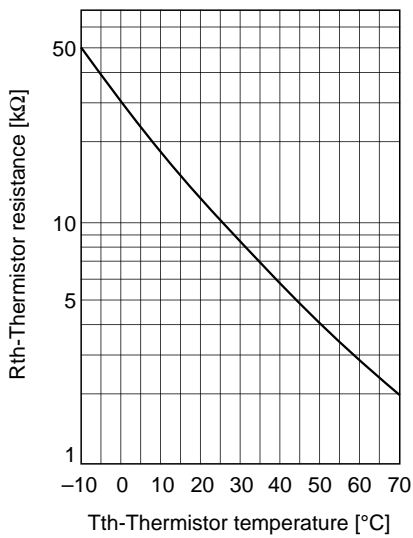

Power dependence of Spectrum (Tth = 25°C)

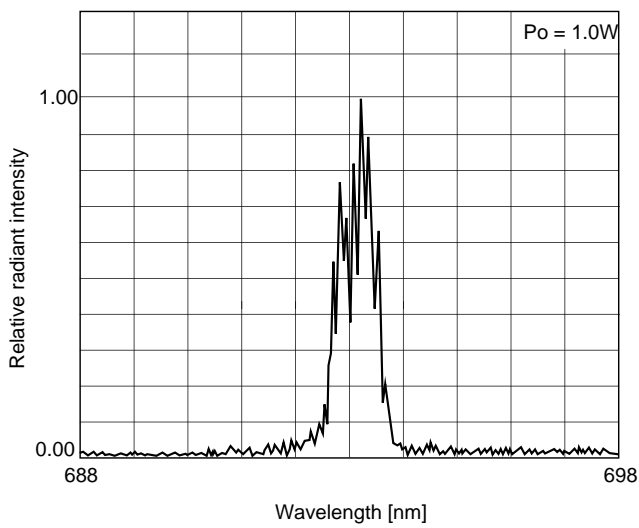
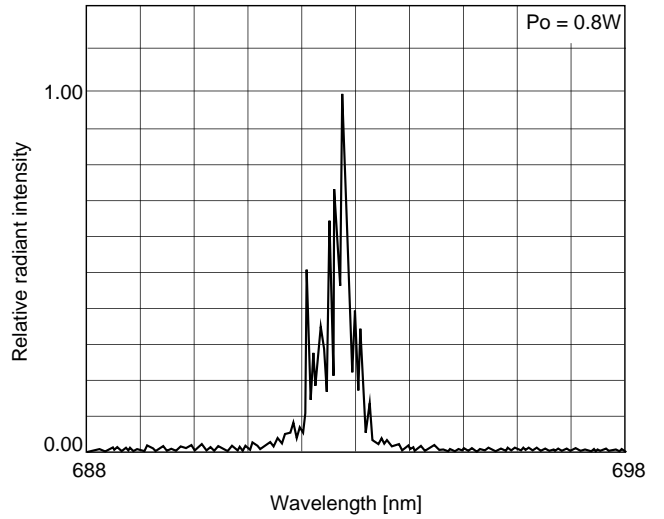
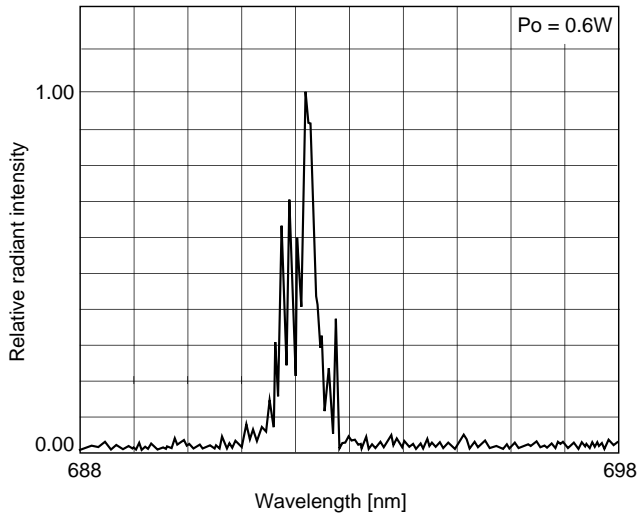
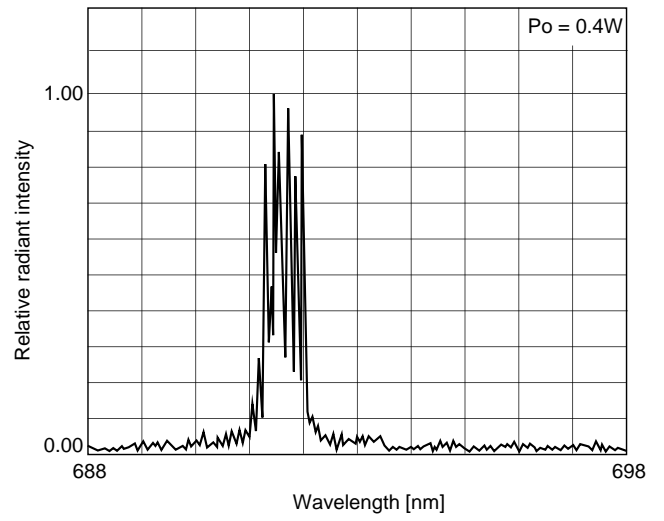
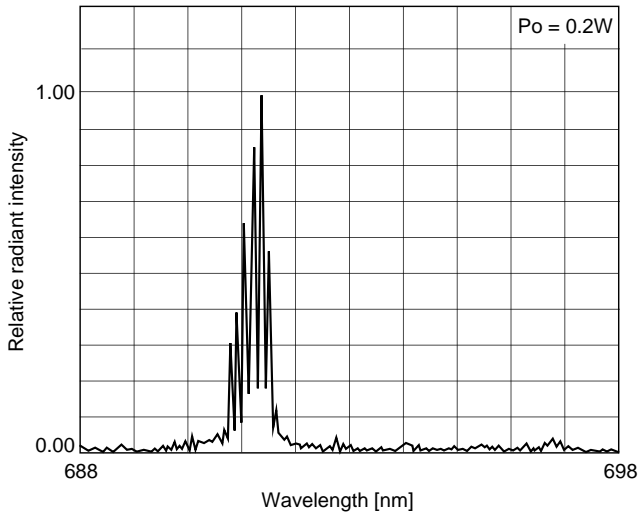

Temperature dependence of Spectrum ( $P_o = 1W$ )

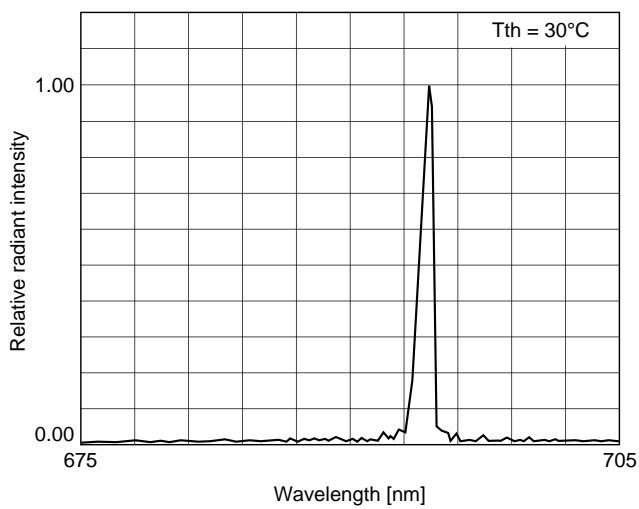
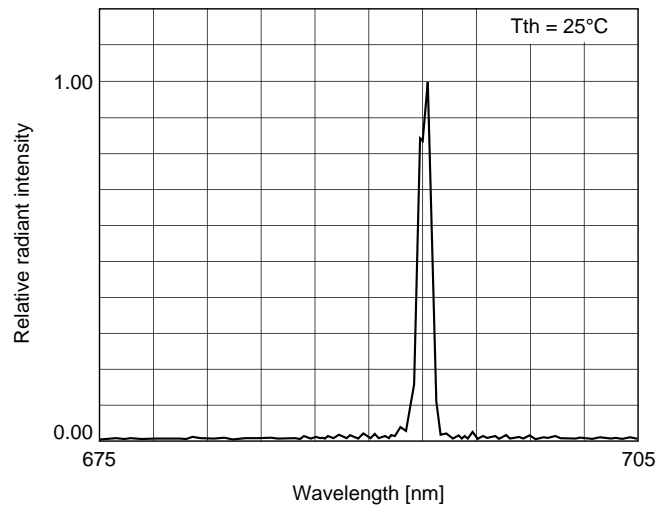
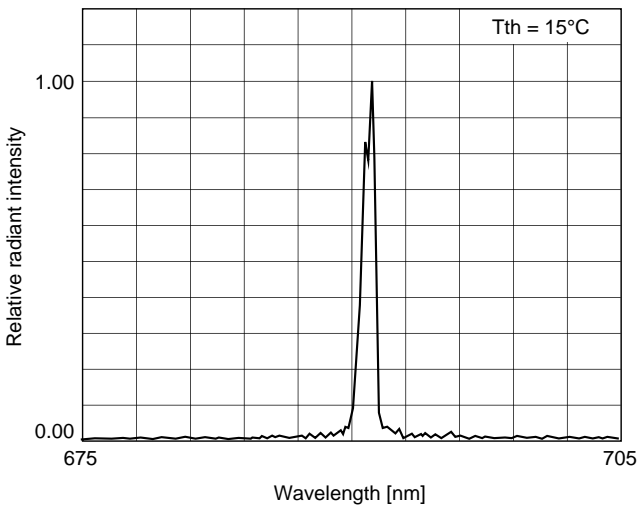
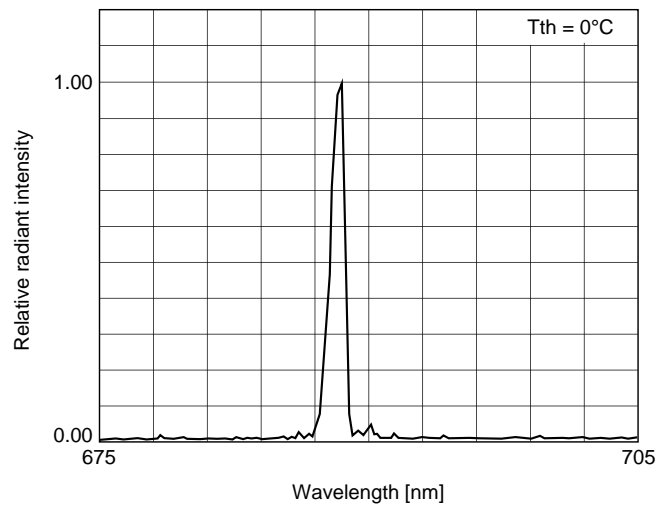
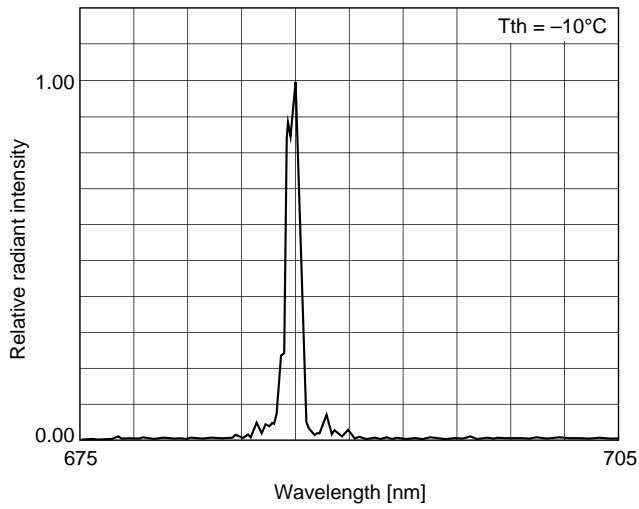

Package Outline

Unit: mm

M-272

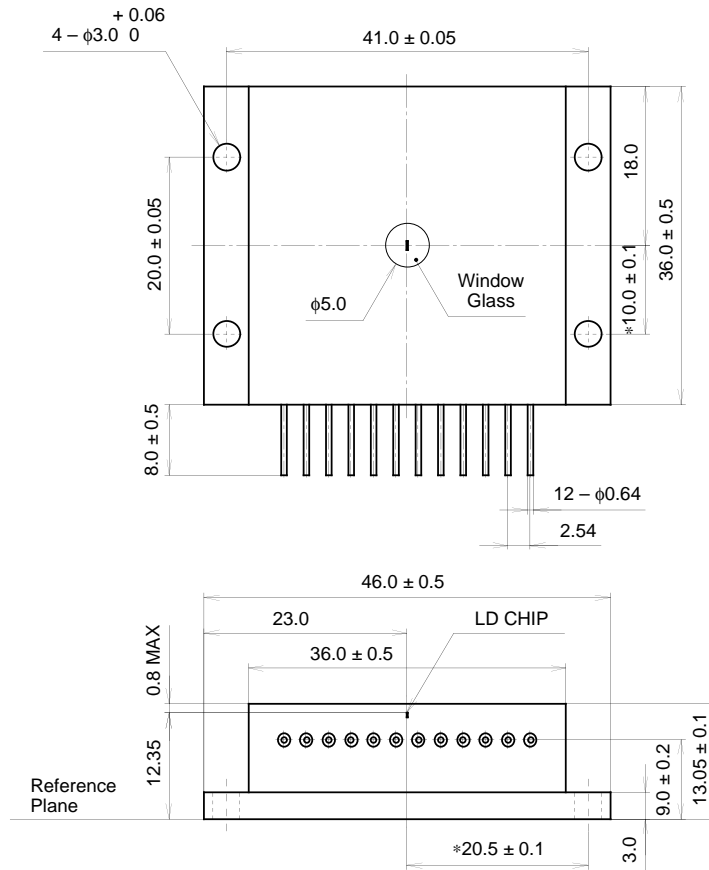

SONY CODE	M-272
EIAJ CODE	_____
JEDEC CODE	_____

\*Distance between pilot hole and emitting area.

PACKAGE WEIGHT	118 g
----------------	-------