

Optical and Electrical Characteristics (T_c = 25°C)T_c: Case temperature

Item	Symbol	Conditions	Min.	Typ.	Max.	Unit	
Threshold current	I _{th}	CW	15	25	35	mA	
Operating current	I _{op}	CW, P _o = 70mW	80	95	115	mA	
Operating voltage	V _{op}	CW, P _o = 70mW	—	2.0	2.3	V	
Wavelength	λ _p	CW, P _o = 70mW	778	784	792	nm	
Differential efficiency	η _D	CW, P _o = 70mW	0.8	1.0	1.2	mW/mA	
Radiation angle	Paralell	θ//	CW, P _o = 70mW	7.3	8.2	9.8	deg
	Perpendicular	θ⊥	CW, P _o = 70mW	15.5	18.0	20.5	deg
Astigmatism	A _s	CW, P _o = 70mW	-6	—	0	μm	
Positional accuracy	Angle	Δφ//	CW, P _o = 70mW	—	—	±2.0	deg
		Δφ⊥	CW, P _o = 70mW	—	—	±3.0	deg
	Position	ΔX, ΔY, ΔZ		—	—	±80	μm

Notes on Operation

Care should be taken for the following points when using this product.

- (1) This product corresponds to a Class 3B product under IEC60825-1 and JIS standard C6802 "Laser Product Emission Safety Standards".

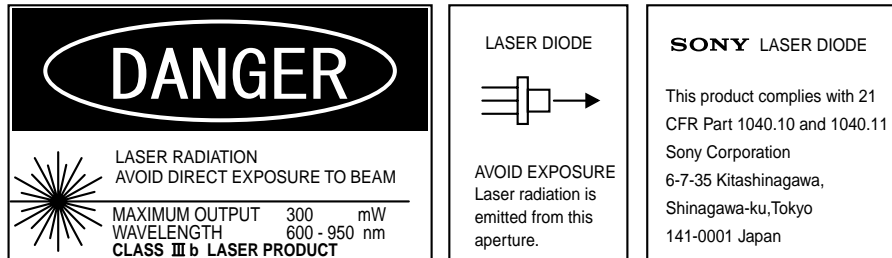

- (2) Eye protection against laser beams

Take care not to allow laser beams to enter your eyes under any circumstances.

For observing laser beams, ALWAYS use safety goggles that block laser beams. Usage of IR scopes, IR cameras and fluorescent plates is also recommended for monitoring laser beams safely.

- (3) Gallium Arsenide

This product uses gallium arsenide (GaAs). This is not a problem for normal use, but GaAs vapors may be potentially hazardous to the human body. Therefore, never crush, heat to the maximum storage temperature or higher, or place the product in your mouth.

In addition, the following disposal methods are recommended when disposing of this product.

1. Engaging the services of a contractor certified in the collection, transport and intermediate treatment of items containing arsenic.
2. Managing the product through to final disposal as specially managed industrial waste which is handled separately from general industrial waste and household waste.

- (4) Prevention of surge current and electrostatic discharge

Laser diodes are most sensitive to electrostatic discharge among semiconductors. When a large current is passed through the laser diode for even an extremely short time, the strong light emitted from the laser diode promotes deterioration and then destruction of the laser diode. Therefore, note that surge current should not flow to the laser diode driving circuit from switches and others. Also, if the laser diode is handled carelessly, it may be destroyed instantly because electrostatic discharge is easily applied by a human body. Therefore, be extremely careful about overcurrent and electrostatic discharge.

- (5) Use for special applications

This product is not designed or manufactured for use in equipment used under circumstances where failure may pose a risk to life and limb, or result in significant material damage, etc.

Consult your Sony sales representative when investigating use for medical, vehicle, nuclear power control or other special applications. Also, use the power supply that was designed not to exceed the optical power output specified at the absolute maximum ratings.

Package Outline

Unit: mm

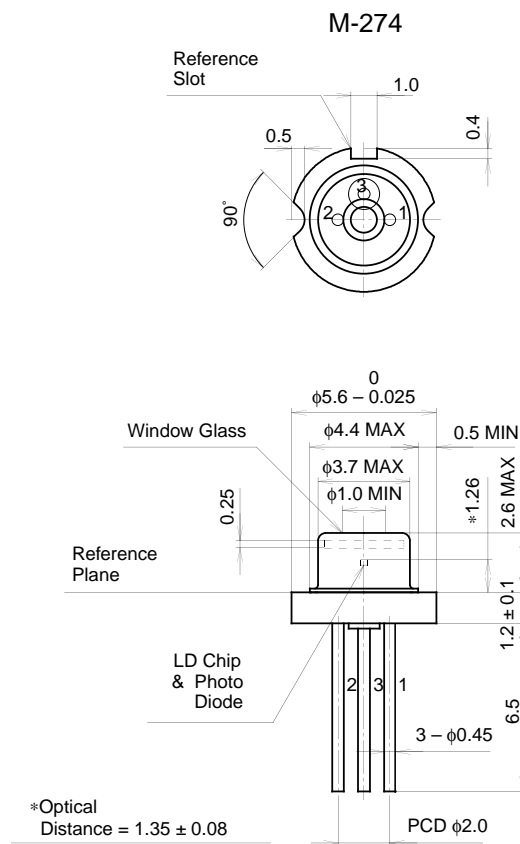

SONY CODE	M-274
EIAJ CODE	_____
JEDEC CODE	_____

PACKAGE MASS	0.3g
--------------	------