



CB-FET

SLP60R460SJ/SLF60R460SJ

SLP60R460SJ/SLF60R460SJ 600V N-Channel MOSFET

General Description

This Power MOSFET is produced using Maple semi's Advanced Super-Junction technology. This advanced technology has been especially tailored to minimize conduction loss, provide superior switching performance, and withstand high energy pulse in the avalanche and commutation mode. These devices are well suited for AC/DC power conversion in switching mode operation for higher efficiency.

Features

- 10A, 600V, $R_{DS(on) typ.} = 0.42\Omega @ V_{GS} = 10V$
- Low gate charge (typical 35nC)
- High ruggedness
- Fast switching
- 100% avalanche tested
- Improved dv/dt capability

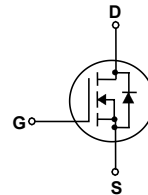
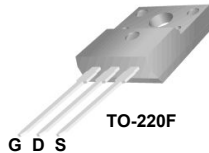
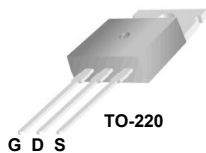

Absolute Maximum Ratings

$T_C = 25^\circ\text{C}$ unless otherwise noted

Symbol	Parameter	SLP60R460SJ	SLF60R460SJ	Units
V_{DSS}	Drain-Source Voltage	600		V
I_D	Drain Current - Continuous ($T_C = 25^\circ\text{C}$) - Continuous ($T_C = 100^\circ\text{C}$)	10	10*	A
		8	8*	A
I_{DM}	Drain Current - Pulsed (Note 1)	40	40*	A
V_{GSS}	Gate-Source Voltage	± 30		V
EAS	Single Pulsed Avalanche Energy (Note 2)	120		mJ
I_{AR}	Avalanche Current (Note 1)	2		A
E_{AR}	Repetitive Avalanche Energy (Note 1)	60		mJ
dv/dt	Peak Diode Recovery dv/dt (Note 3)	4.5		V/ns
P_D	Power Dissipation ($T_C = 25^\circ\text{C}$) - Derate above 25°C	205	35	W
		1.67	0.3	W/ $^\circ\text{C}$
T_J, T_{STG}	Operating and Storage Temperature Range	-55 to +150		$^\circ\text{C}$
T_L	Maximum lead temperature for soldering purposes, 1/8" from case for 5 seconds	300		$^\circ\text{C}$

* Drain current limited by maximum junction temperature.

Thermal Characteristics

Symbol	Parameter	SLP60R460SJ	SLF60R460SJ	Units
$R_{\theta JC}$	Thermal Resistance, Junction-to-Case	0.6	3.6	$^\circ\text{C}/\text{W}$
$R_{\theta JS}$	Thermal Resistance, Case-to-Sink Typ.	0.5	--	$^\circ\text{C}/\text{W}$
$R_{\theta JA}$	Thermal Resistance, Junction-to-Ambient	62	62	$^\circ\text{C}/\text{W}$

Electrical Characteristics $T_C = 25^\circ\text{C}$ unless otherwise noted

Symbol	Parameter	Test Conditions	Min	Typ	Max	Units
Off Characteristics						
BV _{DSS}	Drain-Source Breakdown Voltage	V _{GS} = 0 V, I _D = 250 μ A, T _J =25 $^\circ$ C	600	--	--	V
		V _{GS} = 0 V, I _D = 250 μ A, T _J =150 $^\circ$ C	--	650	--	V
$\frac{\Delta BV_{DSS}}{\Delta T_J}$	Breakdown Voltage Temperature Coefficient	I _D = 250 μ A, Referenced to 25 $^\circ$ C	--	0.6	--	V/ $^\circ$ C
I _{DSS}	Zero Gate Voltage Drain Current	V _{DS} = 600 V, V _{GS} = 0 V	--	--	1	μ A
		V _{DS} = 480 V, T _C = 125 $^\circ$ C	--	--	10	μ A
I _{GSSF}	Gate-Body Leakage Current, Forward	V _{GS} = 30 V, V _{DS} = 0 V	--	--	100	nA
I _{GSSR}	Gate-Body Leakage Current, Reverse	V _{GS} = -30 V, V _{DS} = 0 V	--	--	-100	nA
On Characteristics						
V _{GS(th)}	Gate Threshold Voltage	V _{DS} = V _{GS} , I _D = 250 μ A	2.5	--	4.5	V
R _{DS(on)}	Static Drain-Source On-Resistance	V _{GS} = 10 V, I _D = 5 A	--	0.42	0.46	Ω
g _{FS}	Forward Transconductance	V _{DS} = 40 V, I _D = 5 A (Note 4)	--	16	--	S
R _g	Gate resistance	f=1 MHz, Open drain	--	4.5	--	Ω
Dynamic Characteristics						
C _{iss}	Input Capacitance	V _{DS} = 25 V, V _{GS} = 0 V, f = 1.0 MHz	--	600	--	pF
C _{oss}	Output Capacitance		--	120	--	pF
C _{rss}	Reverse Transfer Capacitance		--	55	--	pF
Switching Characteristics						
t _{d(on)}	Turn-On Delay Time	V _{DD} = 400 V, I _D = 5 A, R _G = 20 Ω (Note 4, 5)	--	25	--	ns
t _r	Turn-On Rise Time		--	55	--	ns
t _{d(off)}	Turn-Off Delay Time		--	70	--	ns
t _f	Turn-Off Fall Time		--	40	--	ns
Q _g	Total Gate Charge	V _{DS} = 480 V, I _D = 10 A, V _{GS} = 10 V (Note 4, 5)	--	35	--	nC
Q _{gs}	Gate-Source Charge		--	3.8	--	nC
Q _{gd}	Gate-Drain Charge		--	4	--	nC
Drain-Source Diode Characteristics and Maximum Ratings						
I _S	Maximum Continuous Drain-Source Diode Forward Current		--	--	10	A
I _{SM}	Maximum Pulsed Drain-Source Diode Forward Current		--	--	38	A
V _{SD}	Drain-Source Diode Forward Voltage	V _{GS} = 0 V, I _S = 10 A	--	--	1.5	V
t _{rr}	Reverse Recovery Time	V _{GS} = 0 V, I _S = 10 A,	--	240	--	ns
Q _{rr}	Reverse Recovery Charge	dI _F / dt = 100 A/us (Note 4)	--	3.1	--	μ C

NOTES:

1. Repetitive Rating: Pulse width limited by maximum junction temperature
2. L=60mH, I_{AS}=2A, V_{DD}=150V, Starting T_J=25 $^\circ$ C
3. I_{SD}≤10A, di/dt ≤ 200A/us, V_{DD} ≤ BV_{DSS}, Starting T_J = 25 $^\circ$ C
4. Pulse Test: Pulse width ≤ 300us, Duty Cycle ≤ 2%
5. Essentially Independent of Operating Temperature Typical Characteristics

Typical Characteristics (Continued)

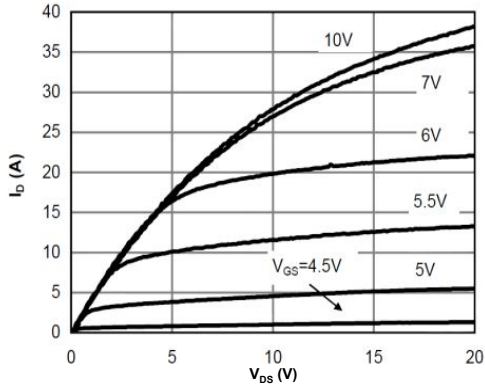

Figure 1: On-Region Characteristics@25°C

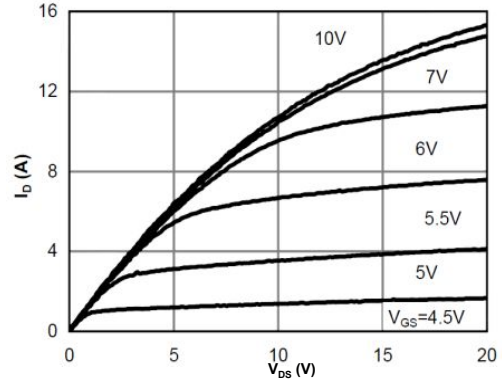

Figure 2: On-Region Characteristics@125°C

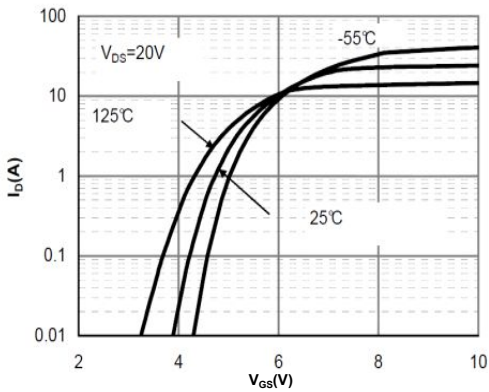

Figure 3: Transfer Characteristics

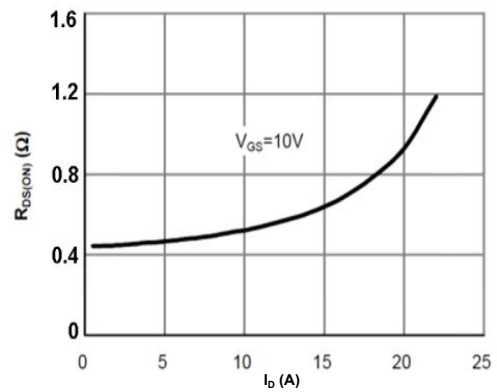

Figure 4: On-Resistance vs. Drain Current and Gate Voltage

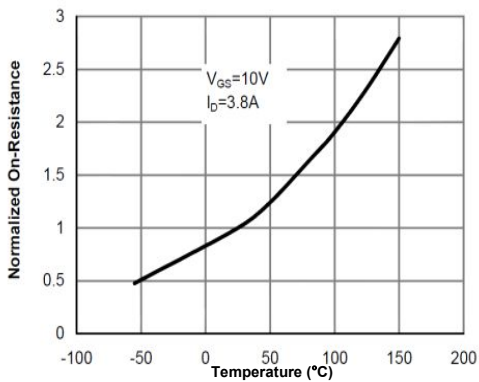

Figure 5: On-Resistance vs. Junction Temperature

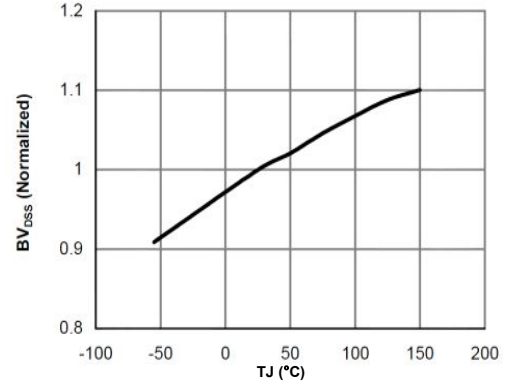

Figure 6: Break Down vs. Junction Temperature

Typical Characteristics (Continued)

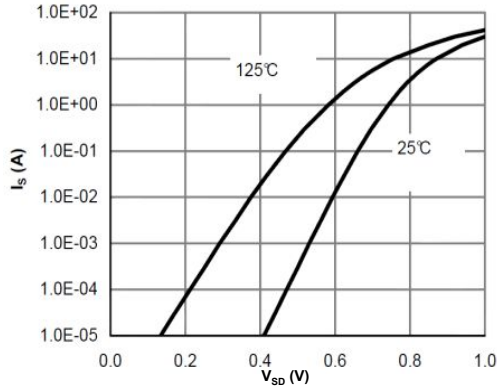

Figure 7: Body-Diode Characteristics

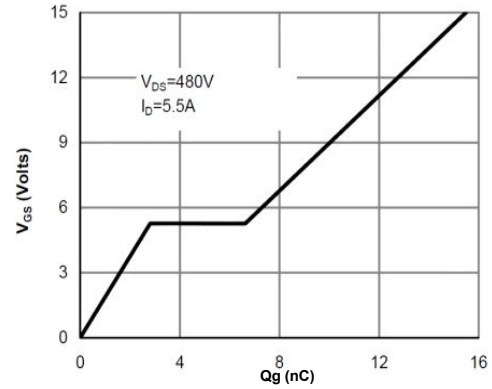

Figure 8: Gate-Charge Characteristics

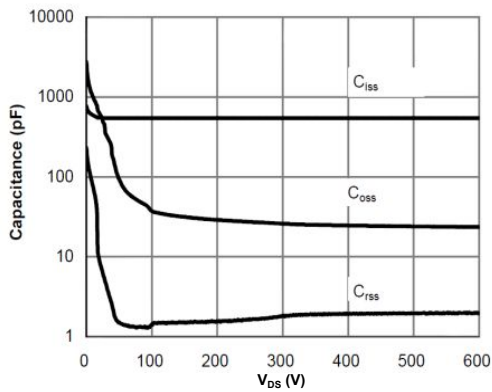

Figure 9: Capacitance Characteristics

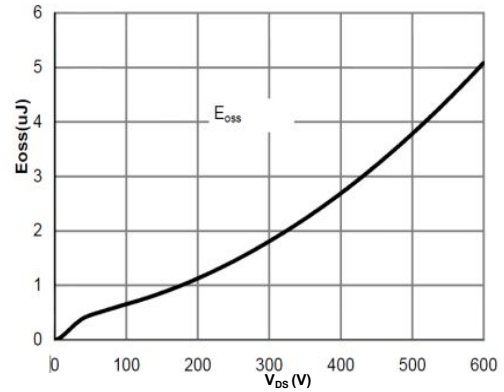

Figure 10: C_{oss} stored Energy

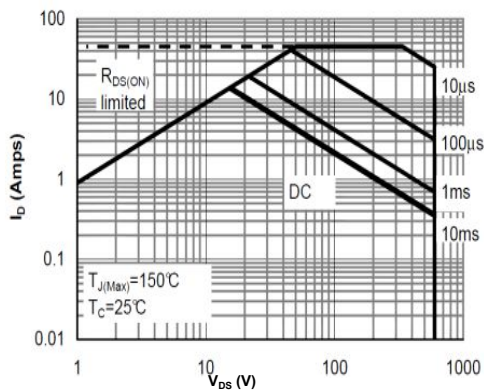

Figure 11: Maximum Forward Biased Safe Operating Area

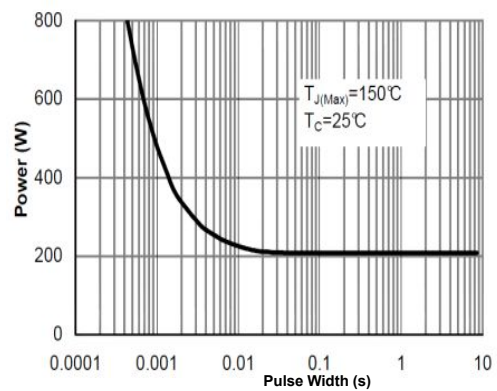

Figure 12: Single Pulse Power Rating Junction-to-Case

Typical Characteristics (Continued)

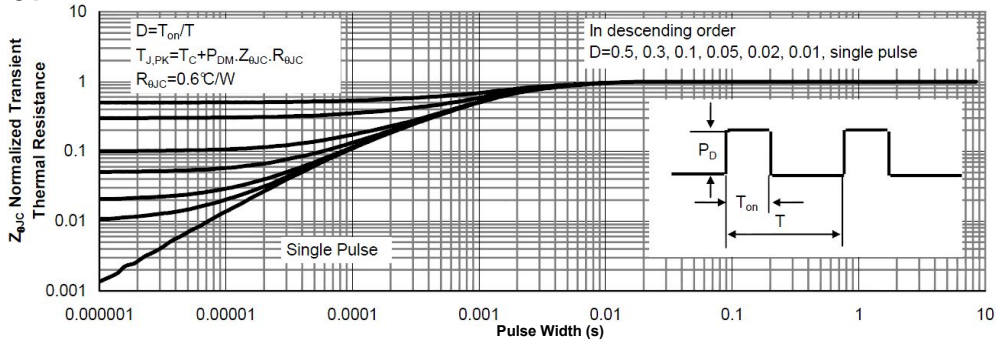

Figure 13: Normalized Maximum Transient Thermal Impedance

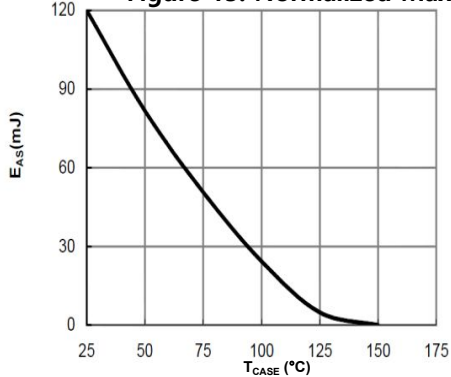

Figure 14: Avalanche energy

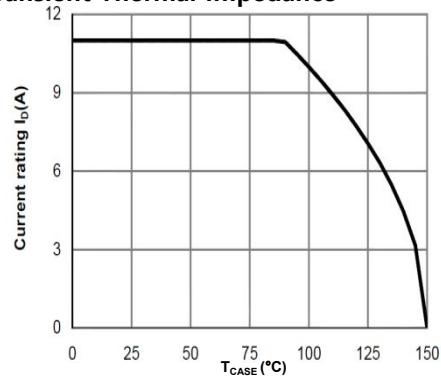

Figure 15: Current De-rating

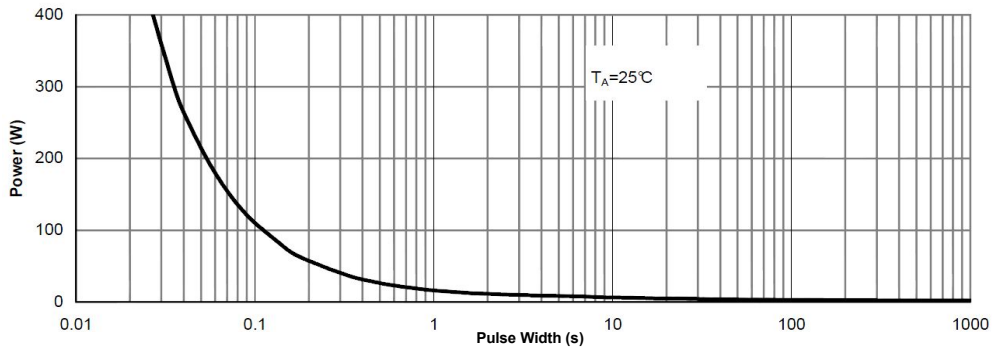

Figure 16: Single Pulse Power Rating Junction-to-Ambient

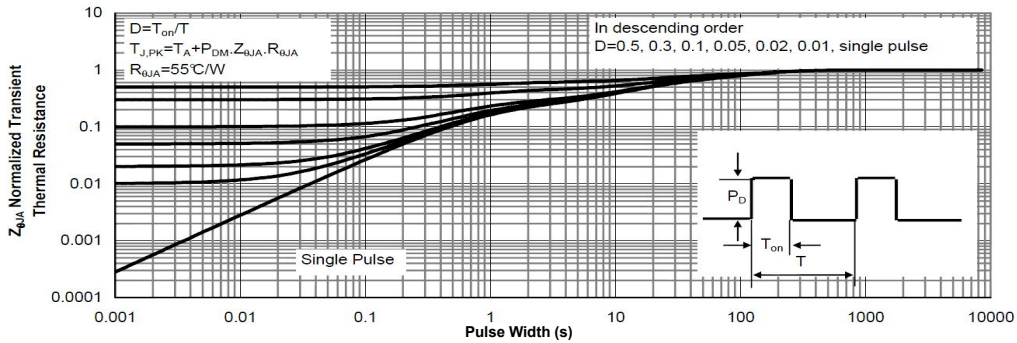
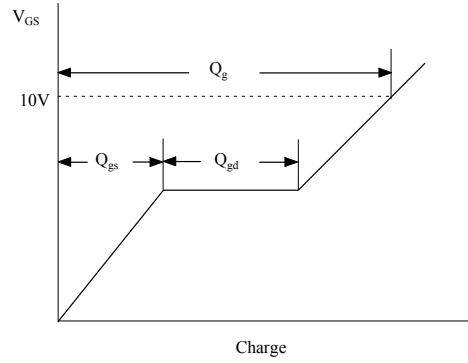
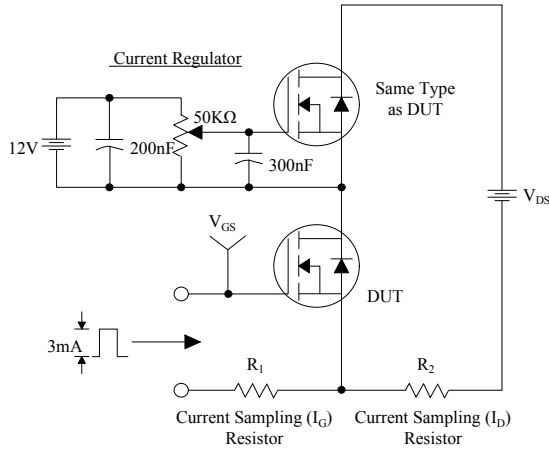
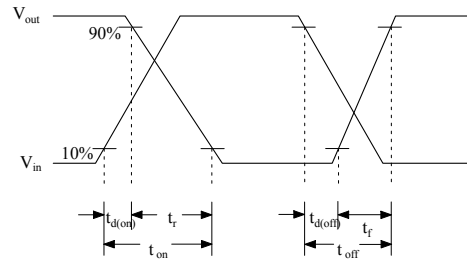
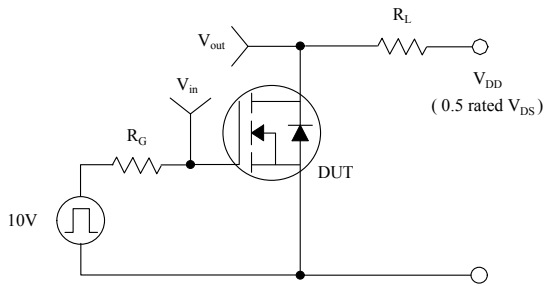

Figure 17: Normalized Maximum Transient Thermal Impedance

Gate Charge Test Circuit & Waveform



Resistive Switching Test Circuit & Waveforms



Unclamped Inductive Switching Test Circuit & Waveforms

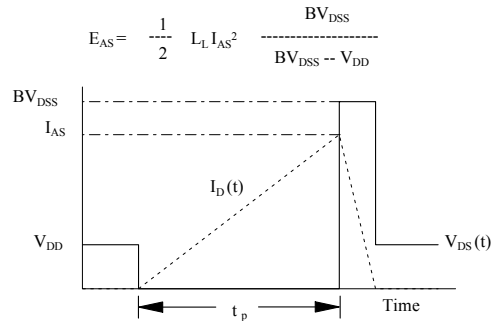
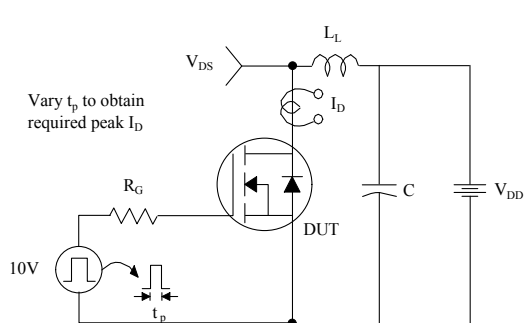

Peak Diode Recovery dv/dt Test Circuit & Waveforms

