

SLP65R190SJ / SLF65R190SJ 650V N-Channel MOSFET

General Description

This Power MOSFET is produced using Maple semi's Advanced Super-Junction technology. This advanced technology has been especially tailored to minimize conduction loss, provide superior switching performance, and withstand high energy pulse in the avalanche and commutation mode. These devices are well suited for AC/DC power conversion in switching mode operation for higher efficiency.

Features

- 20A, 650V, $R_{DS(on) typ.} = 0.16\Omega @ V_{GS} = 10V$
- Low gate charge (typical 70nC)
- High ruggedness
- Fast switching
- 100% avalanche tested
- Improved dv/dt capability

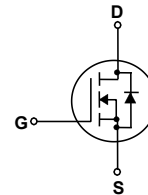
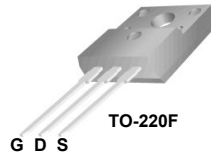
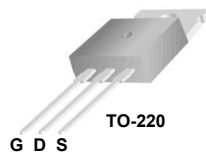

Absolute Maximum Ratings

$T_C = 25^\circ\text{C}$ unless otherwise noted

Symbol	Parameter	SLP65R190SJ	SLF65R190SJ	Units
V_{DSS}	Drain-Source Voltage	650		V
I_D	Drain Current - Continuous ($T_C = 25^\circ\text{C}$) - Continuous ($T_C = 100^\circ\text{C}$)	20	20 *	A
		10	10 *	A
I_{DM}	Drain Current - Pulsed (Note 1)	62	62 *	A
V_{GSS}	Gate-Source Voltage	± 30		V
EAS	Single Pulsed Avalanche Energy (Note 2)	485		mJ
I_{AR}	Avalanche Current (Note 1)	20		A
E_{AR}	Repetitive Avalanche Energy (Note 1)	1		mJ
dv/dt	Peak Diode Recovery dv/dt (Note 3)	4.5		V/ns
P_D	Power Dissipation ($T_C = 25^\circ\text{C}$) - Derate above 25°C	205	35	W
		1.67	0.3	W/ $^\circ\text{C}$
T_J, T_{STG}	Operating and Storage Temperature Range	-55 to +150		$^\circ\text{C}$
T_L	Maximum lead temperature for soldering purposes, 1/8" from case for 5 seconds	300		$^\circ\text{C}$

* Drain current limited by maximum junction temperature.

Thermal Characteristics

Symbol	Parameter	SLP65R190SJ	SLF65R190SJ	Units
$R_{\theta JC}$	Thermal Resistance, Junction-to-Case	0.6	3.6	$^\circ\text{C}/\text{W}$
$R_{\theta JS}$	Thermal Resistance, Case-to-Sink Typ.	0.5	--	$^\circ\text{C}/\text{W}$
$R_{\theta JA}$	Thermal Resistance, Junction-to-Ambient	62	80	$^\circ\text{C}/\text{W}$

Electrical CharacteristicsT_C = 25°C unless otherwise noted

Symbol	Parameter	Test Conditions	Min	Typ	Max	Units
Off Characteristics						
BV _{DSS}	Drain-Source Breakdown Voltage	V _{GS} = 0 V, I _D = 250 uA	650	--	--	V
$\frac{\Delta BV_{DSS}}{\Delta T_J}$	Breakdown Voltage Temperature Coefficient	I _D = 250 uA, Referenced to 25°C	--	0.6	--	V/°C
I _{DSS}	Zero Gate Voltage Drain Current	V _{DS} = 650 V, V _{GS} = 0 V	--	--	1	uA
		V _{DS} = 480 V, T _C = 125°C	--	--	10	uA
I _{GSSF}	Gate-Body Leakage Current, Forward	V _{GS} = 30 V, V _{DS} = 0 V	--	--	100	nA
I _{GSSR}	Gate-Body Leakage Current, Reverse	V _{GS} = -30 V, V _{DS} = 0 V	--	--	-100	nA
On Characteristics						
V _{GS(th)}	Gate Threshold Voltage	V _{DS} = V _{GS} , I _D = 250 uA	2.5	--	4.5	V
R _{DS(on)}	Static Drain-Source On-Resistance	V _{GS} = 10 V, I _D = 5 A	--	0.16	0.19	Ω
g _{FS}	Forward Transconductance	V _{DS} = 40 V, I _D = 5 A (Note 4)	--	16	--	S
Dynamic Characteristics						
C _{iss}	Input Capacitance	V _{DS} = 25 V, V _{GS} = 0 V, f = 1.0 MHz	--	1440	--	pF
C _{oss}	Output Capacitance		--	300	--	pF
C _{rss}	Reverse Transfer Capacitance		--	10	--	pF
Switching Characteristics						
t _{d(on)}	Turn-On Delay Time	V _{DD} = 400 V, I _D = 5 A, R _G = 20 Ω (Note 4, 5)	--	25	--	ns
t _r	Turn-On Rise Time		--	55	--	ns
t _{d(off)}	Turn-Off Delay Time		--	70	--	ns
t _f	Turn-Off Fall Time		--	40	--	ns
Q _g	Total Gate Charge	V _{DS} = 480 V, I _D = 10 A, V _{GS} = 10 V (Note 4, 5)	--	70	--	nC
Q _{gs}	Gate-Source Charge		--	7.8	--	nC
Q _{gd}	Gate-Drain Charge		--	9	--	nC
Drain-Source Diode Characteristics and Maximum Ratings						
I _S	Maximum Continuous Drain-Source Diode Forward Current		--	--	20	A
I _{SM}	Maximum Pulsed Drain-Source Diode Forward Current		--	--	60	A
V _{SD}	Drain-Source Diode Forward Voltage	V _{GS} = 0 V, I _S = 4.9 A	--	--	1.5	V
t _{rr}	Reverse Recovery Time	V _{GS} = 0 V, I _S = 4.9 A,	--	475	--	ns
Q _{rr}	Reverse Recovery Charge	dI _F / dt = 100 A/us (Note 4)	--	5.8	--	uC

Notes:

1. Repetitive Rating : Pulse width limited by maximum junction temperature
2. I_{AS} = 3.5A, V_{DD} = 50V, R_G = 25Ω, Starting T_J = 25°C
3. I_{SD} ● I_D, di/dt ● 200A/us, V_{DD} ● BV_{DSS}, Starting T_J = 25°C
4. Pulse Test : Pulse width ● 300us, Duty cycle ● 2%
5. Essentially independent of operating temperature

Typical Characteristics

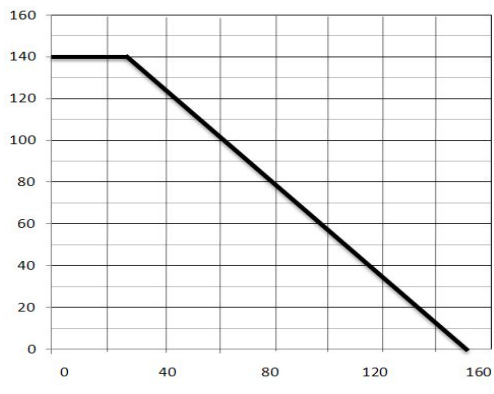

Figure 1. Power Dissipation for SLP65R190SJ

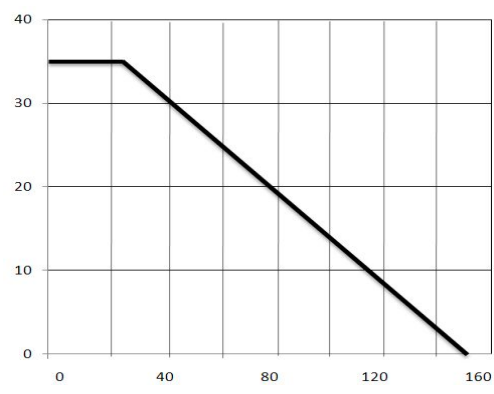

Figure 2. Power Dissipation for SLF65R190SJ

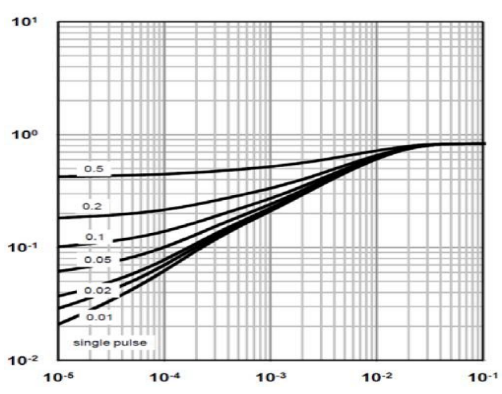

Figure 3. Transient Thermal Response Curve for SLP65R190SJ

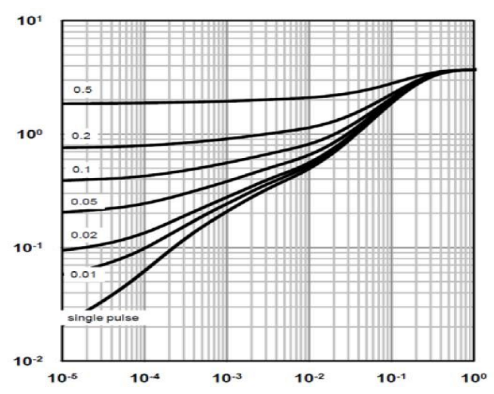

Figure 4. Transient Thermal Response Curve for SLF65R190SJ

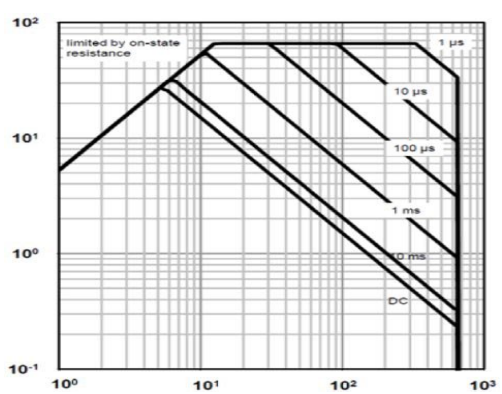

Figure 5. Maximum Safe Operating Area for SLP65R190SJ@25°C

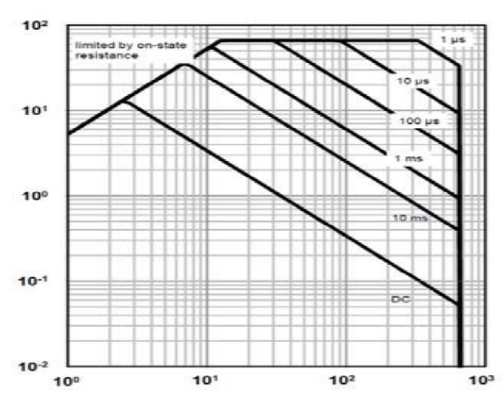

Figure 6. Maximum Safe Operating Area for SLF65R190SJ@25°C

Typical Characteristics (Continued)

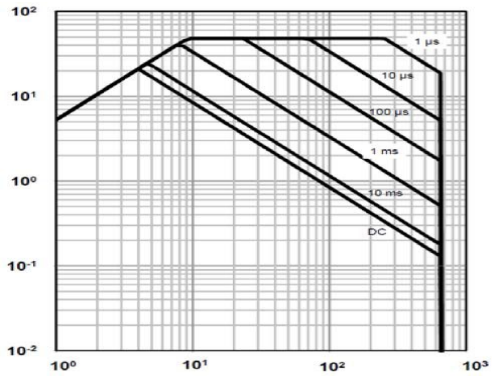

Figure 7. Maximum Safe Operating Area for SLP65R190SJ@80°C

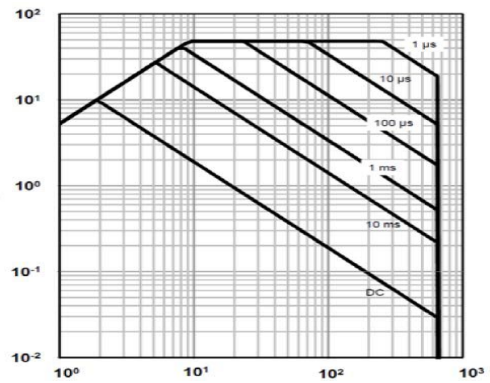

Figure 8. Maximum Safe Operating Area for SLP65R190SJ@80°C

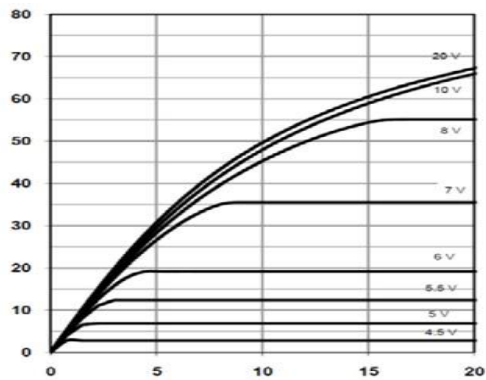

Figure 9. On-Region Characteristics@25°C

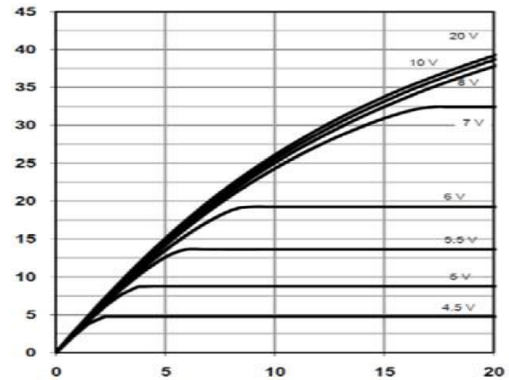

Figure 10. On-Region Characteristics@125°C

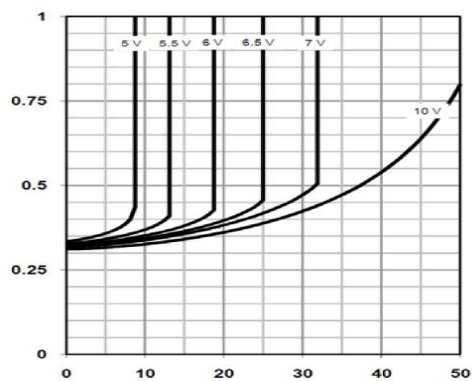

Figure 11. On-Resistance Variation vs Drain Current and Gate Voltage@125°C

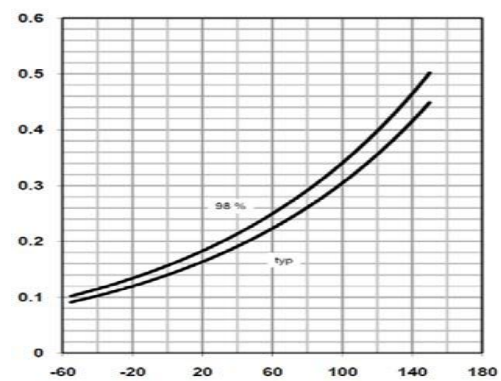

Figure 12. On-Resistance Variation vs Temperature

Typical Characteristics (Continued)

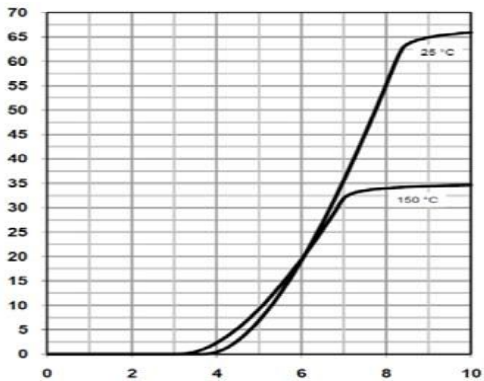

Figure 13. Transfer Characteristics

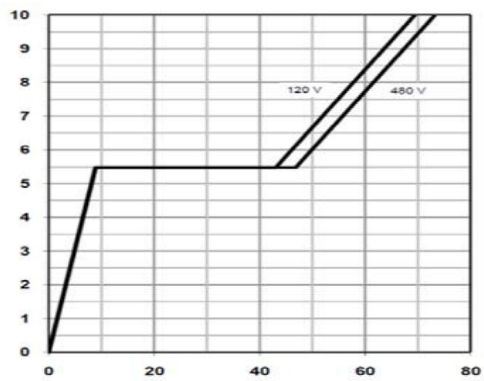

Figure 14. Gate Charge Characteristics

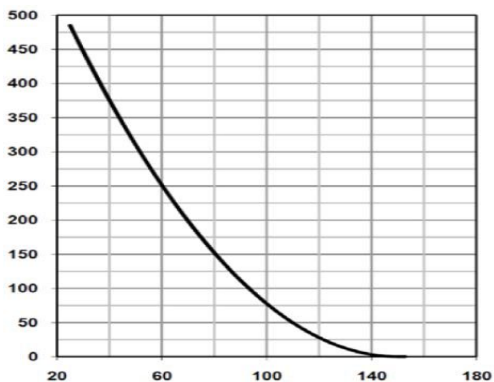

Figure 15. Avalanche Energy Characteristics

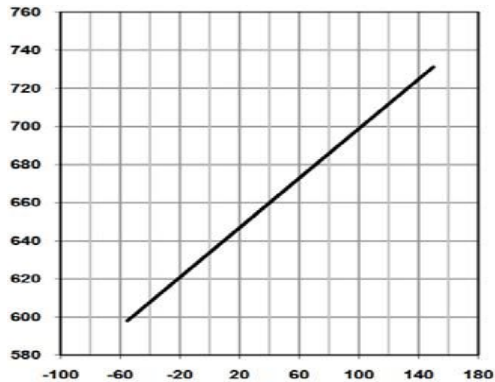

Figure 16. Breakdown Voltage Variation vs Temperature

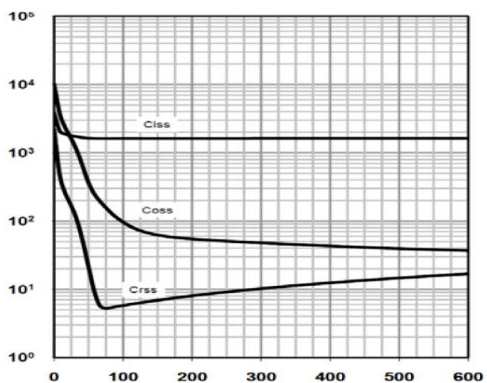

Figure 17. Capacitance Characteristics

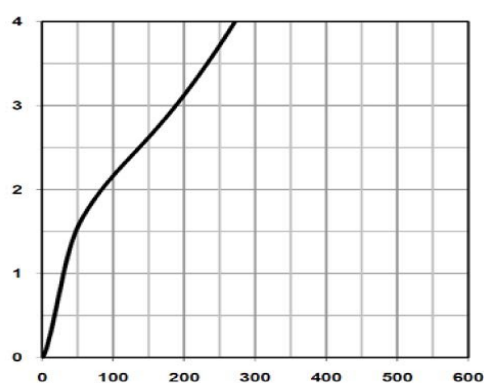

Figure 18. On-Resistance Variation vs Temperature

Typical Characteristics (Continued)

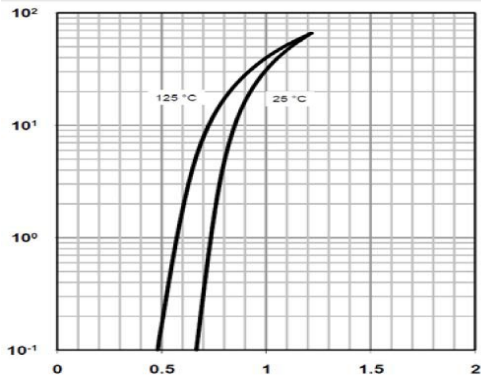
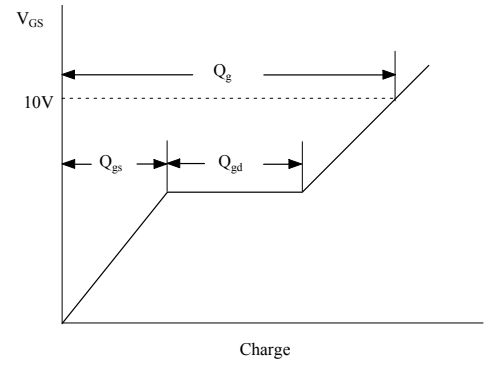
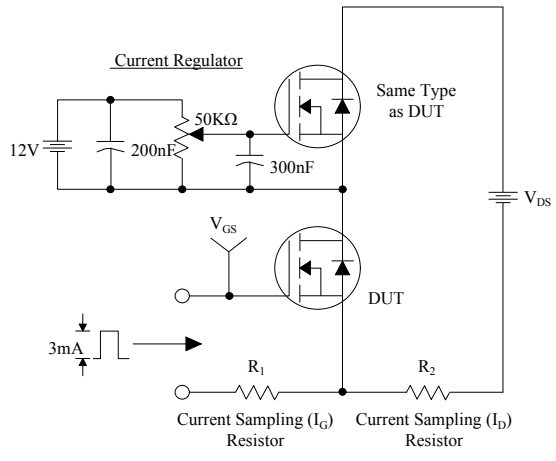
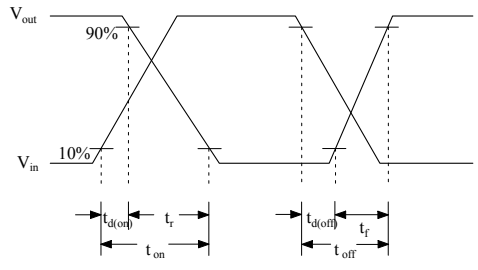
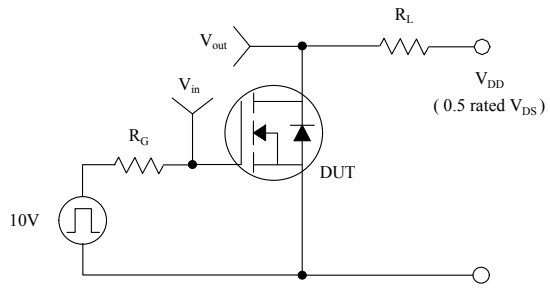

Figure 19. Body Diode Forward Voltage Variation with Source Current and Temperature

Gate Charge Test Circuit & Waveform



Resistive Switching Test Circuit & Waveforms



Unclamped Inductive Switching Test Circuit & Waveforms

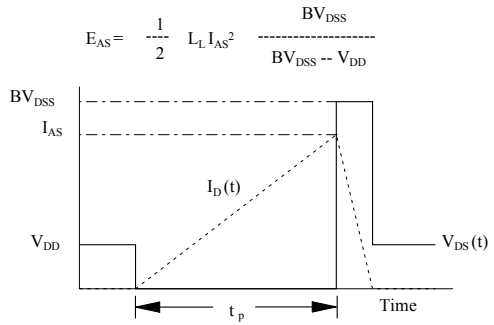
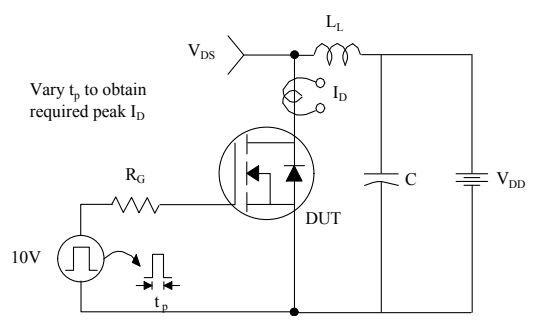

Peak Diode Recovery dv/dt Test Circuit & Waveforms

