



# SLP830UZ / SLF830UZ 550V N-Channel MOSFET

SLP830UZ / SLF830UZ

## General Description

This Power MOSFET is produced using Maple semi's advanced planar stripe DMOS technology. This advanced technology has been especially tailored to minimize on-state resistance, provide superior switching performance, and withstand high energy pulse in the avalanche and commutation mode. These devices are well suited for high efficiency switched mode power supplies, active power factor correction based on half bridge topology.

## Features

- 5.0A, 550V,  $R_{DS(on) typ.} = 1.0\Omega @ V_{GS} = 10V$
- Low gate charge ( typical 16.3nC)
- High ruggedness
- Fast switching
- 100% avalanche tested
- Improved dv/dt capability

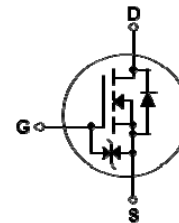
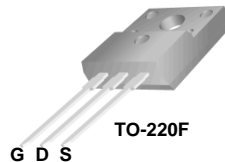
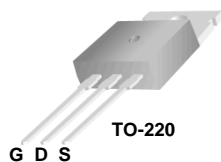

## Absolute Maximum Ratings T<sub>C</sub> = 25°C unless otherwise noted

Symbol	Parameter	SLP830UZ	SLF830UZ	Units
V <sub>DSS</sub>	Drain-Source Voltage	550		V
I <sub>D</sub>	Drain Current - Continuous (T <sub>C</sub> = 25°C) - Continuous (T <sub>C</sub> = 100°C)	5.0	5.0*	A
		3.0	3.0*	A
I <sub>DM</sub>	Drain Current - Pulsed (Note 1)	20	20*	A
V <sub>GSS</sub>	Gate-Source Voltage	±20		V
EAS	Single Pulsed Avalanche Energy (Note 2)	190		mJ
I <sub>AR</sub>	Avalanche Current (Note 1)	5.0		A
E <sub>AR</sub>	Repetitive Avalanche Energy (Note 1)	7.5		mJ
dv/dt	Peak Diode Recovery dv/dt (Note 3)	4.5		V/ns
P <sub>D</sub>	Power Dissipation (T <sub>C</sub> = 25°C) - Derate above 25°C	75	30	W
		0.60	0.24	W/°C
T <sub>J</sub> , T <sub>STG</sub>	Operating and Storage Temperature Range	-55 to +150		°C
T <sub>L</sub>	Maximum lead temperature for soldering purposes, 1/8" from case for 5 seconds	300		°C
V <sub>ESD(G-S)</sub>	Gate Source ESD (HBM – C = 100pF, R = 1.5KΩ)	2500		V

## Thermal Characteristics

Symbol	Parameter	SLP830UZ	SLF830UZ	Units
R <sub>θJC</sub>	Thermal Resistance, Junction-to-Case	1.67	4.17	°C/W
R <sub>θJS</sub>	Thermal Resistance, Case-to-Sink Typ.	0.5	--	°C/W
R <sub>θJA</sub>	Thermal Resistance, Junction-to-Ambient	62.5	62.5	°C/W

**Electrical Characteristics**T<sub>C</sub> = 25°C unless otherwise noted

Symbol	Parameter	Test Conditions	Min	Typ	Max	Units
<b>Off Characteristics</b>						
BV <sub>DSS</sub>	Drain-Source Breakdown Voltage	V <sub>GS</sub> = 0 V, I <sub>D</sub> = 250 μA	550	--	--	V
$\frac{\Delta BV_{DSS}}{\Delta T_J}$	Breakdown Voltage Temperature Coefficient	I <sub>D</sub> = 250 μA, Referenced to 25°C	--	0.55	--	V/°C
I <sub>DSS</sub>	Zero Gate Voltage Drain Current	V <sub>DS</sub> = 550 V, V <sub>GS</sub> = 0 V	--	--	1	μA
		V <sub>DS</sub> = 440 V, T <sub>C</sub> = 125°C	--	--	10	μA
I <sub>GSSF</sub>	Gate-Body Leakage Current, Forward	V <sub>GS</sub> = 20 V, V <sub>DS</sub> = 0 V	--	--	10	μA
I <sub>GSSR</sub>	Gate-Body Leakage Current, Reverse	V <sub>GS</sub> = -20 V, V <sub>DS</sub> = 0 V	--	--	-10	μA
<b>On Characteristics</b>						
V <sub>GS(th)</sub>	Gate Threshold Voltage	V <sub>DS</sub> = V <sub>GS</sub> , I <sub>D</sub> = 250 μA	2.0	--	4.0	V
R <sub>DS(on)</sub>	Static Drain-Source On-Resistance	V <sub>GS</sub> = 10 V, I <sub>D</sub> = 2.5 A	--	1.0	1.3	Ω
g <sub>FS</sub>	Forward Transconductance	V <sub>DS</sub> = 40 V, I <sub>D</sub> = 2.5 A (Note 4)	--	3.0	--	S
<b>Dynamic Characteristics</b>						
C <sub>iss</sub>	Input Capacitance	V <sub>DS</sub> = 25 V, V <sub>GS</sub> = 0 V, f = 1.0 MHz	--	682	--	pF
C <sub>oss</sub>	Output Capacitance		--	23	--	pF
C <sub>rss</sub>	Reverse Transfer Capacitance		--	9	--	pF
<b>Switching Characteristics</b>						
t <sub>d(on)</sub>	Turn-On Delay Time	V <sub>DD</sub> = 275 V, I <sub>D</sub> = 5.0 A, R <sub>G</sub> = 25 Ω (Note 4, 5)	--	25	--	ns
t <sub>r</sub>	Turn-On Rise Time		--	23	--	ns
t <sub>d(off)</sub>	Turn-Off Delay Time		--	92.5	--	ns
t <sub>f</sub>	Turn-Off Fall Time		--	47	--	ns
Q <sub>g</sub>	Total Gate Charge	V <sub>DS</sub> = 440 V, I <sub>D</sub> = 5.0 A, V <sub>GS</sub> = 10 V (Note 4, 5)	--	16.3	--	nC
Q <sub>gs</sub>	Gate-Source Charge		--	3.6	--	nC
Q <sub>gd</sub>	Gate-Drain Charge		--	5.1	--	nC
<b>Drain-Source Diode Characteristics and Maximum Ratings</b>						
I <sub>S</sub>	Maximum Continuous Drain-Source Diode Forward Current		--	--	5	A
I <sub>SM</sub>	Maximum Pulsed Drain-Source Diode Forward Current		--	--	20	A
V <sub>SD</sub>	Drain-Source Diode Forward Voltage	V <sub>GS</sub> = 0 V, I <sub>S</sub> = 5.0 A	--	--	1.4	V
t <sub>rr</sub>	Reverse Recovery Time	V <sub>GS</sub> = 0 V, I <sub>S</sub> = 5.0 A,	--	312	--	ns
Q <sub>rr</sub>	Reverse Recovery Charge	di <sub>F</sub> / dt = 100 A/us (Note 4)	--	2.1	--	μC

**Notes:**

1. Repetitive Rating : Pulse width limited by maximum junction temperature
2. L = 14mH, I<sub>AS</sub> = 5.0A, V<sub>DD</sub> = 50V, R<sub>G</sub> = 25Ω, Starting T<sub>J</sub> = 25°C
3. I<sub>SD</sub> ≤ 5.0A, di/dt ≤ 200A/us, V<sub>DD</sub> ≤ BV<sub>DSS</sub>, Starting T<sub>J</sub> = 25°C
4. Pulse Test : Pulse width ≤ 300us, Duty cycle ≤ 2%
5. Essentially independent of operating temperature

### Typical Characteristics

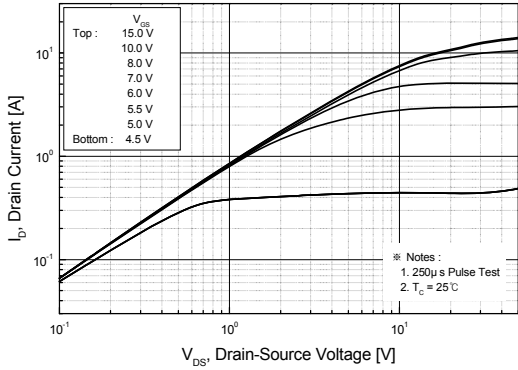

Figure 1. On-Region Characteristics

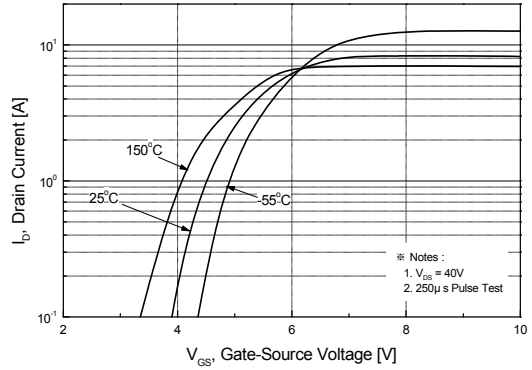

Figure 2. Transfer Characteristics

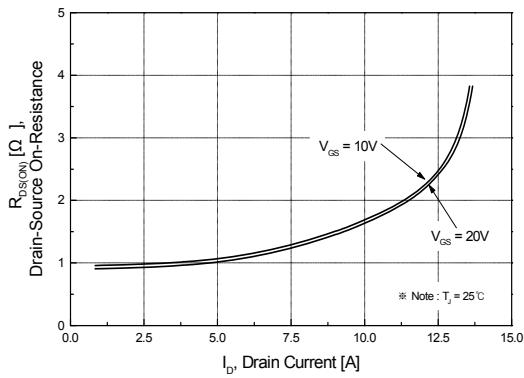

Figure 3. On-Resistance Variation vs Drain Current and Gate Voltage

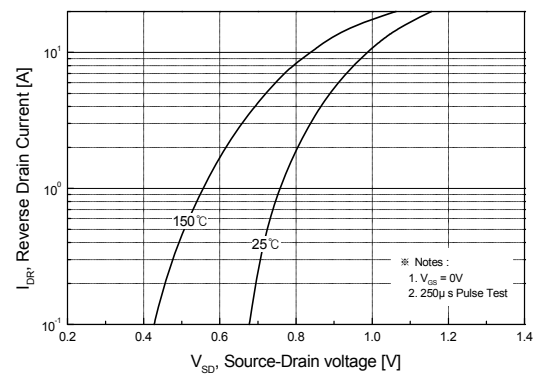

Figure 4. Body Diode Forward Voltage Variation with Source Current and Temperature

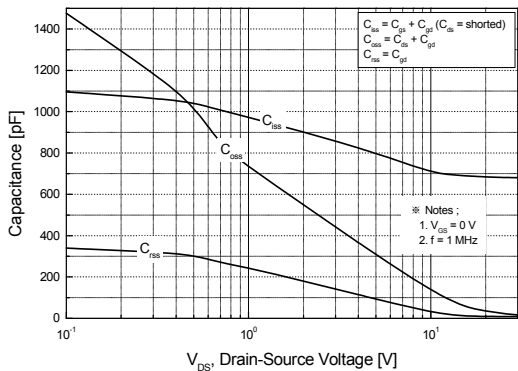

Figure 5. Capacitance Characteristics

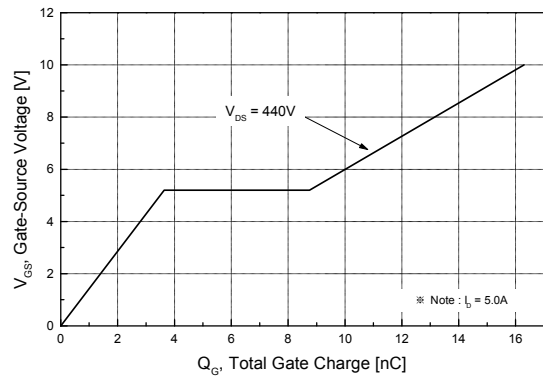

Figure 6. Gate Charge Characteristics

Typical Characteristics (Continued)

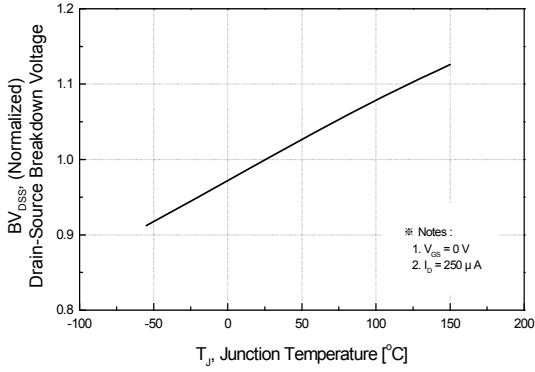

Figure 7. Breakdown Voltage Variation vs Temperature

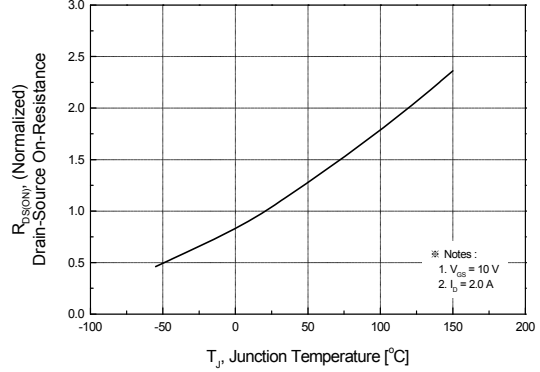

Figure 8. On-Resistance Variation vs Temperature

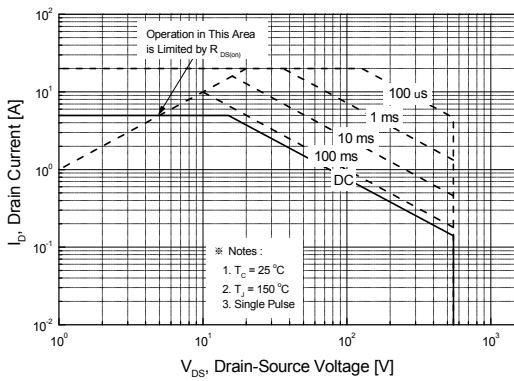

Figure 9-1. Maximum Safe Operating Area For SLP830UZ

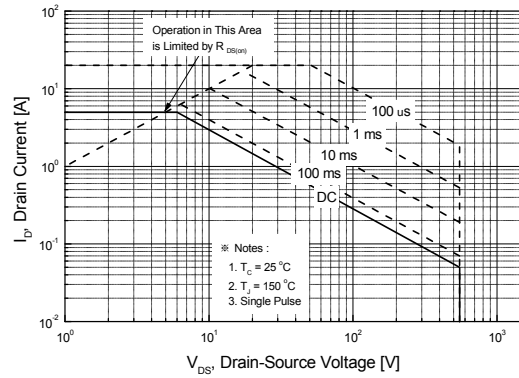

Figure 9-2. Maximum Safe Operating Area For SLF830UZ

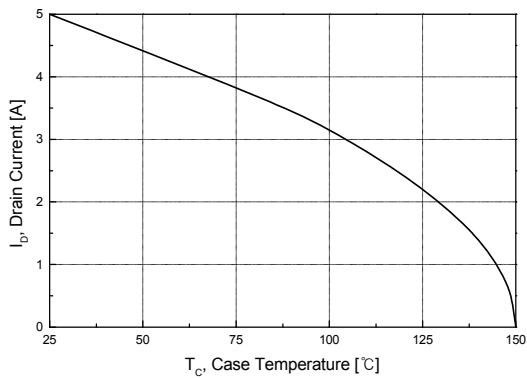

Figure 10. Maximum Drain Current vs Case Temperature

Typical Characteristics (Continued)

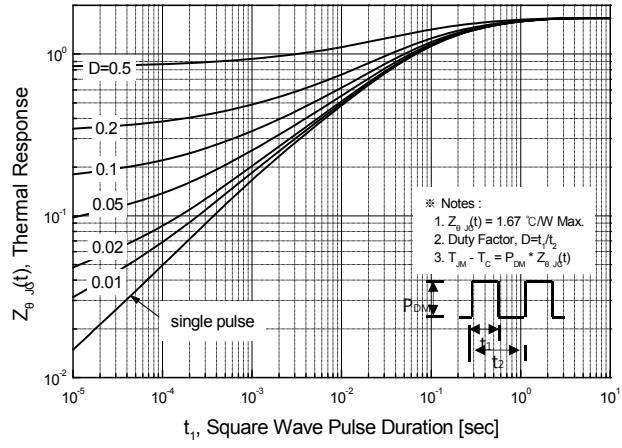

Figure 11-1. Transient Thermal Response Curve For SLP830UZ

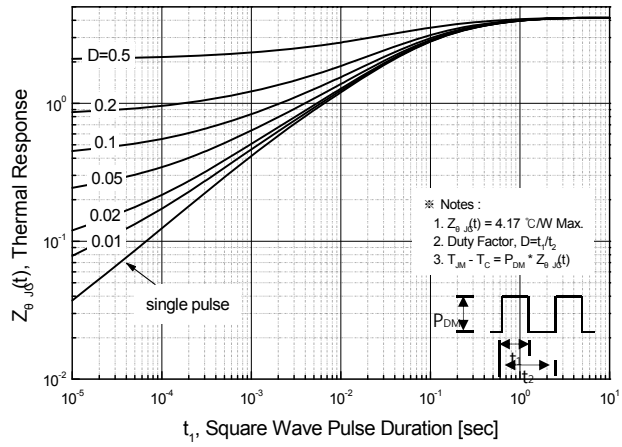
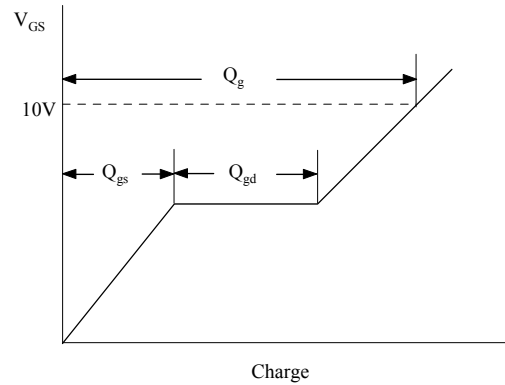
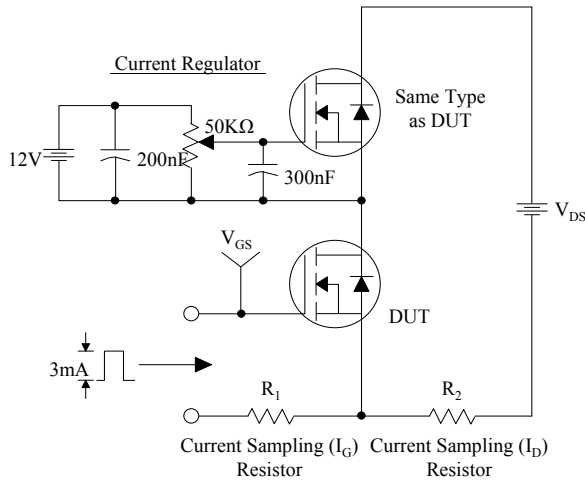
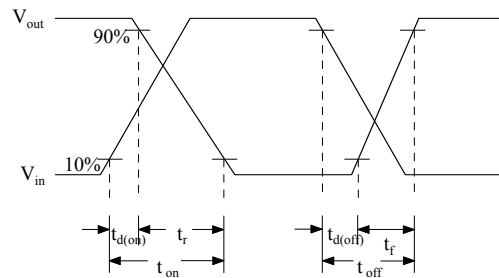
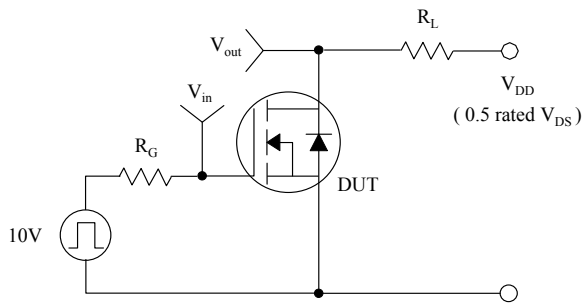

Figure 11-2. Transient Thermal Response Curve For SLF830UZ

### Gate Charge Test Circuit & Waveform



### Resistive Switching Test Circuit & Waveforms



### Unclamped Inductive Switching Test Circuit & Waveforms

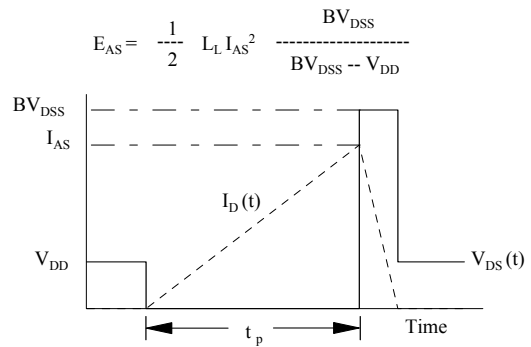
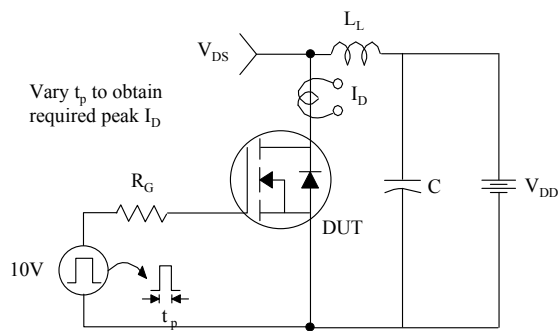

### Peak Diode Recovery dv/dt Test Circuit & Waveforms

