



General Description

The SLG59M1556V is designed for load switching applications. The part comes with one 15.5 mΩ 2.0 A rated MOSFET controlled by a single ON control pin. The product is packaged in an ultra-small 1.0 x 1.0 mm package.

Features

- One 15.5 mΩ 2.0 A MOSFET
- $V_D = 0.85\text{ V to }1.9\text{ V}$
- One integrated VGS Charge Pump
- Over Temperature Protection
- Pb-Free / Halogen-Free / RoHS compliant
- STDFN 4L, 1.0 x 1.0 x 0.55 mm

Pin Configuration

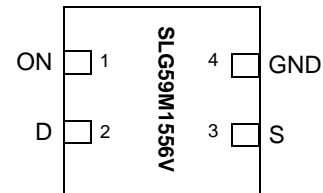

4-pin STDFN
(Top View)

Block Diagram

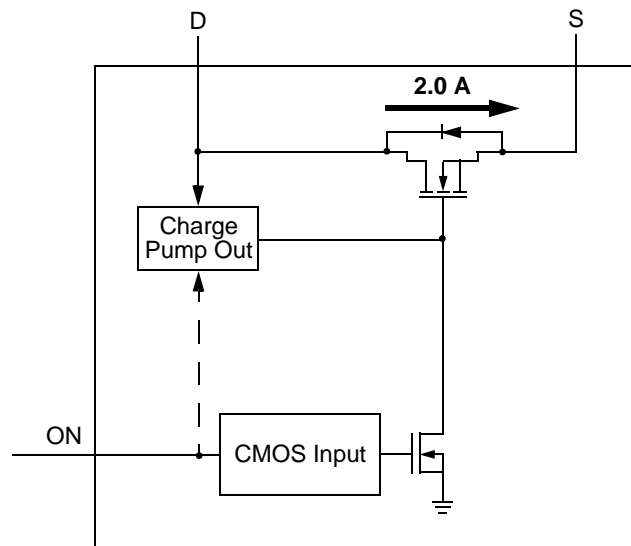



Pin Description

Pin #	Pin Name	Type	Pin Description
1	ON	Input	Turns on MOSFET.
2	D	MOSFET	Drain of Power MOSFET
3	S	MOSFET	Source of Power MOSFET
4	GND	GND	Ground

Ordering Information

Part Number	Type	Production Flow
SLG59M1556V	STDFN 4L	Industrial, -40 °C to 85 °C
SLG59M1556VTR	STDFN 4L (Tape and Reel)	Industrial, -40 °C to 85 °C



Absolute Maximum Ratings

Parameter	Description	Conditions	Min.	Typ.	Max.	Unit
V_D	Power Supply		--	--	2.5	V
T_S	Storage Temperature		-65	--	150	°C
ESD_{HBM}	ESD Protection	Human Body Model	2000	--	--	V
W_{DIS}	Package Power Dissipation		--	--	0.5	W
MOSFET IDS_{PK}	Peak Current from Drain to Source	For no more than 1 ms with 1% duty cycle	--	--	2.5	A

Note: Stresses greater than those listed under "Absolute Maximum Ratings" may cause permanent damage to the device. This is a stress rating only and functional operation of the device at these or any other conditions above those indicated in the operational sections of this specification is not implied. Exposure to absolute maximum rating conditions for extended periods may affect reliability.

Electrical Characteristics

$T_A = -40\text{ °C to }85\text{ °C}$ (unless otherwise stated)

Parameter	Description	Conditions	Min.	Typ.	Max.	Unit
V_D	Power Supply Voltage	-40 °C to 85 °C	0.85	--	1.9	V
I_{DD}	Power Supply Current (PIN 2)	when OFF, $D = 1.9\text{ V}$	--	0.5	1	μA
		when ON, No load	--	30	40	μA
RDS_{ON}	Static Drain to Source ON Resistance	$T_A\ 25\text{ °C MOSFET}$	--	15.5	16.8	$\text{m}\Omega$
		$T_A\ 85\text{ °C MOSFET}$	--	18.0	19.4	$\text{m}\Omega$
IDS	Operating Current	$V_D = 0.85\text{ V to }1.9\text{ V}$	--	--	2.0	A
T_{ON_Delay}	ON pin Delay Time	50% ON to Ramp Begin $V_D = 1.2\text{ V}$, Source_Cap = 10 μF , $R_L = 20\ \Omega$	--	90	200	μs
T_{Total_ON}	Total Turn On Time	$V_D = 1.2\text{ V}$, Source_Cap = 10 μF , $R_L = 20\ \Omega$	--	310	500	μs
$T_{SLEWRATE}$	Slew Rate	$V_D = 1.2\text{ V}$, Source_Cap = 10 μF , $R_L = 20\ \Omega$	--	4.8	--	V/ms
ON_V_{IH}	Initial Turn On Voltage	Internal Charge Pump ON	0.85	--	V_D	V
ON_V_{IL}	Low Input Voltage on ON pin	Internal Charge Pump OFF	-0.3	0	0.3	V
ON_R	Input Impedance on ON pin		100	--	--	$\text{M}\Omega$
$THERM_{ON}$	Thermal shutoff turn-on temperature		--	120	--	°C
$THERM_{OFF}$	Thermal shutoff turn-off temperature		--	100	--	°C
$THERM_{TIME}$	Thermal shutoff time		--	--	1	ms
T_{Delay_OFF}	OFF Delay Time	50% ON to V_S Fall, $V_D = 1.2\text{ V}$, $R_L = 20\ \Omega$	--	15	--	μs



T_{Total_ON} , T_{ON_Delay} and Slew Rate Measurement

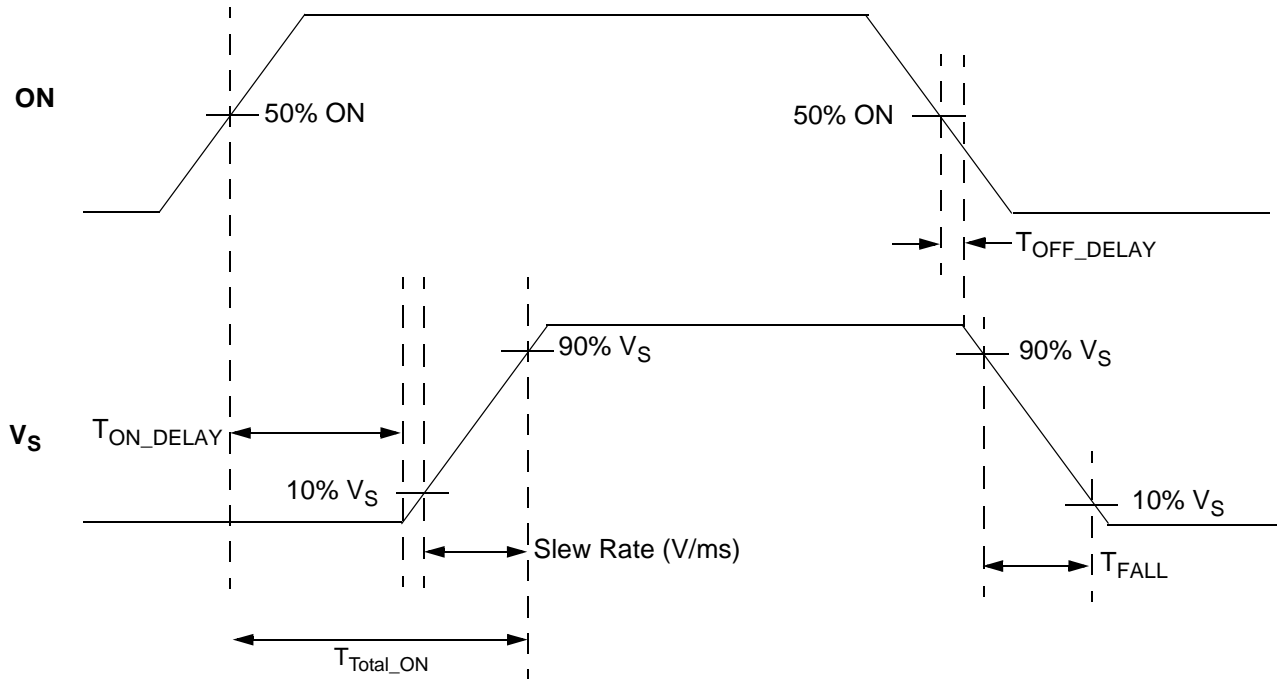

SLG59M1556V Layout Suggestion

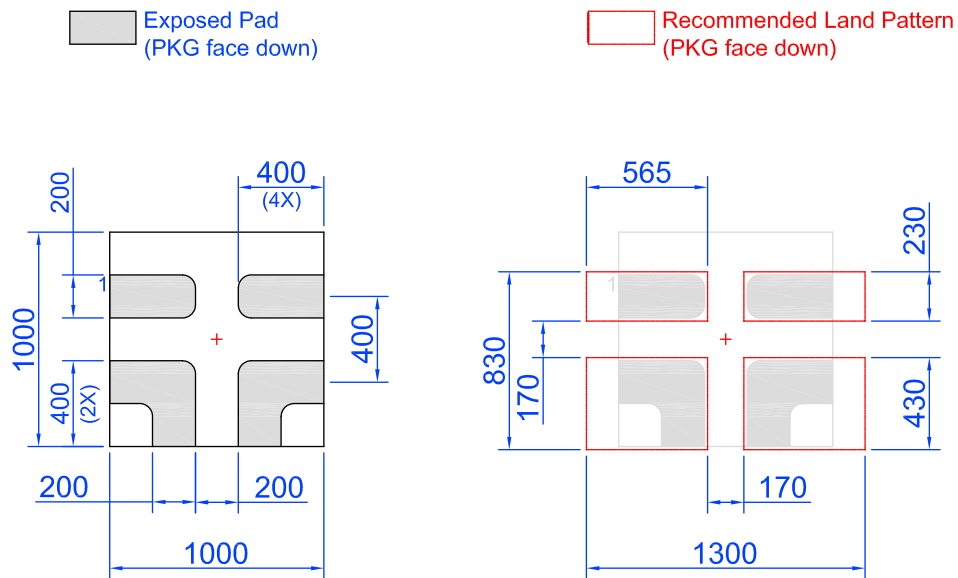

Note: All dimensions shown in micrometers (μm)



Package Top Marking System Definition

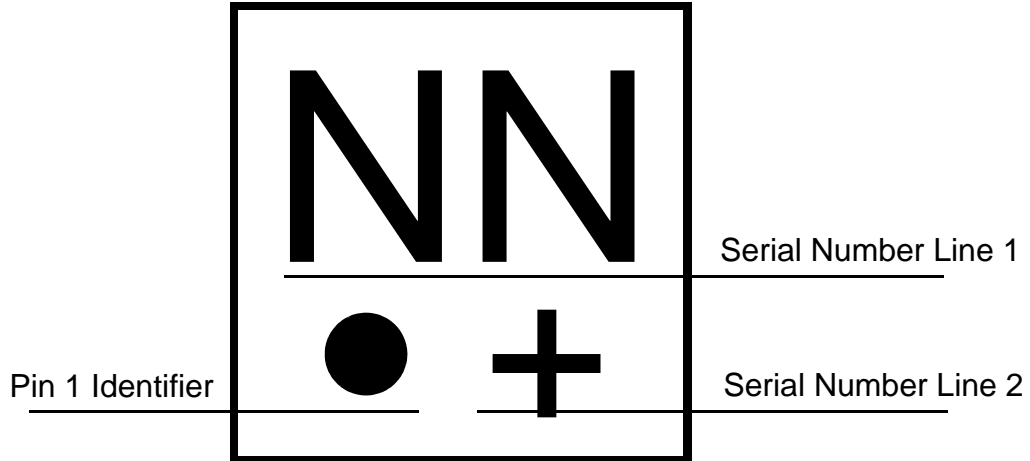

NN - Part Serial Number Field Line 1
where each "N" character can be A-Z and 0-9
+ - Part Serial Number Field Line 2
where "+" character can be +, -, =, or blank



Package Drawing and Dimensions

4 Lead STDFN Package 1.0 x 1.0 mm
IC Net Weight: 0.0016 g

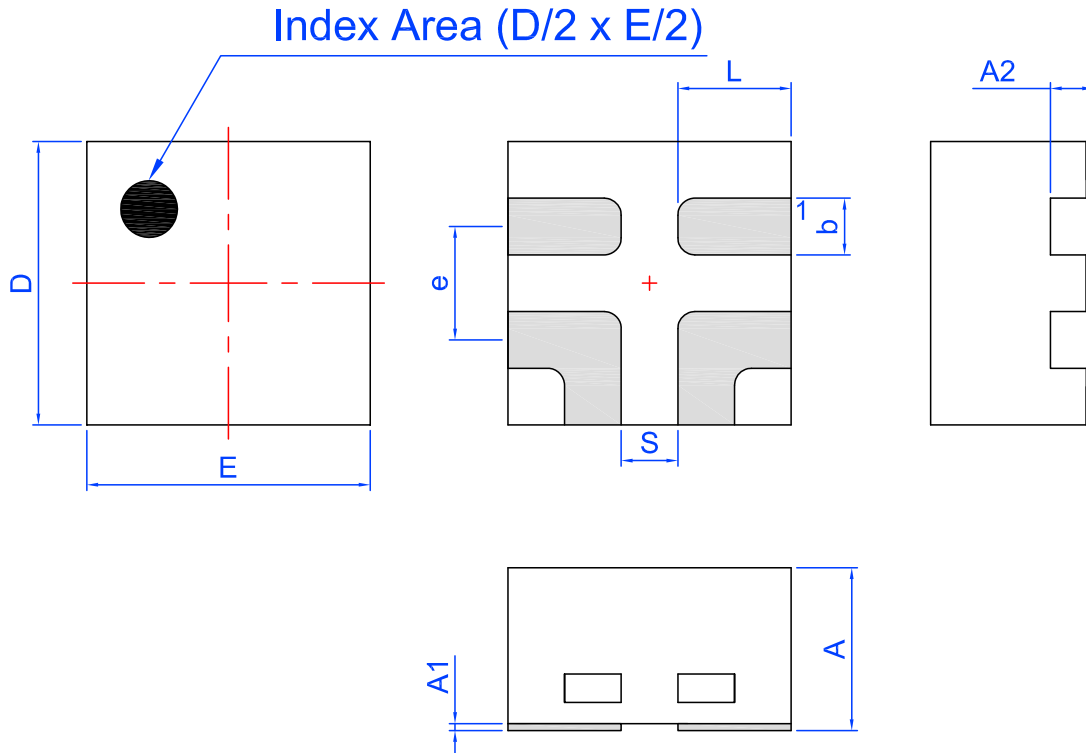

Unit: mm

Symbol	Min	Nom.	Max	Symbol	Min	Nom.	Max
A	0.50	0.55	0.60	D	0.95	1.00	1.05
A1	0.005	-	0.060	E	0.95	1.00	1.05
A2	0.10	0.15	0.20	L	0.35	0.40	0.45
b	0.15	0.20	0.25	S	0.2 REF		
e	0.40 BSC						



Tape and Reel Specifications

Package Type	# of Pins	Nominal Package Size [mm]	Max Units		Reel & Hub Size [mm]	Leader (min)		Trailer (min)		Tape Width [mm]	Part Pitch [mm]
			per Reel	per Box		Pockets	Length [mm]	Pockets	Length [mm]		
STDFN 4L Green	4	1.0 x 1.0 x 0.55	8000	8000	178 / 60	200	400	200	400	8	2

Carrier Tape Drawing and Dimensions

Package Type	Pocket BTM Length	Pocket BTM Width	Pocket Depth	Index Hole Pitch	Pocket Pitch	Index Hole Diameter	Index Hole to Tape Edge	Index Hole to Pocket Center	Tape Width
	A0	B0	K0	P0	P1	D0	E	F	W
STDFN 4L Green	1.16	1.16	0.63	4	2	1.5	1.75	3.5	8

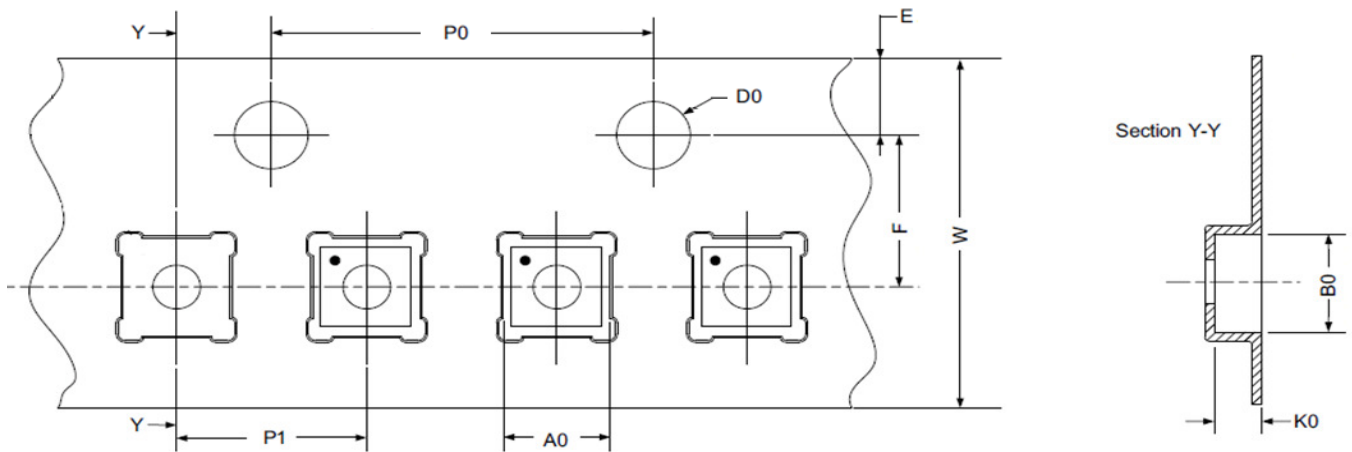

Refer to EIA-481 specification

Recommended Reflow Soldering Profile

Please see IPC/JEDEC J-STD-020: latest revision for reflow profile based on package volume of 0.55 mm³ (nominal). More information can be found at www.jedec.org.



Revision History

Date	Version	Change
11/20/2017	1.02	Updated Package Marking Definition Updated Layout Suggestion