



SLP10N80CZ / SLF10N80CZ

800V N-Channel MOSFET

SLP10N80CZ / SLF10N80CZ

General Description

This Power MOSFET is produced using Maple semi's advanced planar stripe DMOS technology. This advanced technology has been especially tailored to minimize on-state resistance, provide superior switching performance, and withstand high energy pulse in the avalanche and commutation mode. These devices are well suited for high efficiency switched mode power supplies, active power factor correction based on half bridge topology.

Features

- 10A, 800V, $R_{DS(on)Typ.} = 0.85\Omega @ V_{GS} = 10V$
- Low gate charge (typical 63 nC)
- High ruggedness
- Fast switching
- 100% avalanche tested
- Improved dv/dt capability
- ESD Improved capability

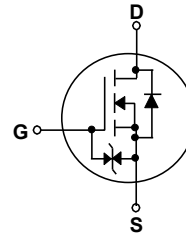
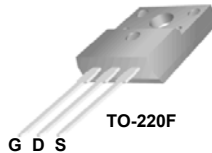
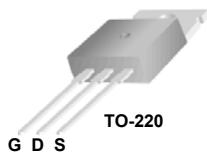

Absolute Maximum Ratings

$T_C = 25^\circ\text{C}$ unless otherwise noted

| Symbol | Parameter | SLP10N80CZ | SLF10N80CZ | Units |
|----------------|---|-------------|------------|---------------------|
| V_{DSS} | Drain-Source Voltage | 800 | | V |
| I_D | Drain Current - Continuous ($T_C = 25^\circ\text{C}$) - Continuous ($T_C = 100^\circ\text{C}$) | 10 | 10* | A |
| | | 6 | 6* | A |
| I_{DM} | Drain Current - Pulsed (Note 1) | 40 | | A |
| V_{GSS} | Gate-Source Voltage | ± 25 | | V |
| EAS | Single Pulsed Avalanche Energy (Note 2) | 350 | | mJ |
| I_{AR} | Avalanche Current (Note 1) | 10 | | A |
| E_{AR} | Repetitive Avalanche Energy (Note 1) | 27.5 | | mJ |
| dv/dt | Peak Diode Recovery dv/dt (Note 3) | 4.5 | | V/ns |
| P_D | Power Dissipation ($T_C = 25^\circ\text{C}$) - Derate above 25°C | 275 | 42 | W |
| | | 2.2 | 0.34 | W/ $^\circ\text{C}$ |
| T_J, T_{STG} | Operating and Storage Temperature Range | -55 to +150 | | $^\circ\text{C}$ |
| T_L | Maximum lead temperature for soldering purposes, 1/8" from case for 5 seconds | 300 | | $^\circ\text{C}$ |

Thermal Characteristics

| Symbol | Parameter | SLP10N80CZ | SLF10N80CZ | Units |
|-----------------|---|------------|------------|---------------------------|
| $R_{\theta JC}$ | Thermal Resistance, Junction-to-Case | 0.45 | 2.95 | $^\circ\text{C}/\text{W}$ |
| $R_{\theta JS}$ | Thermal Resistance, Case-to-Sink Typ. | 0.5 | -- | $^\circ\text{C}/\text{W}$ |
| $R_{\theta JA}$ | Thermal Resistance, Junction-to-Ambient | 62.5 | 62.5 | $^\circ\text{C}/\text{W}$ |

Electrical CharacteristicsT_C = 25°C unless otherwise noted

| Symbol | Parameter | Test Conditions | Min | Typ | Max | Units |
|---|---|--|-----|------|-----|-------|
| Off Characteristics | | | | | | |
| BV _{DSS} | Drain-Source Breakdown Voltage | V _{GS} = 0 V, I _D = 250 μA | 800 | -- | -- | V |
| ΔBV _{DSS} / ΔT _J | Breakdown Voltage Temperature Coefficient | I _D = 250 μA, Referenced to 25°C | -- | 0.8 | -- | V/°C |
| I _{DSS} | Zero Gate Voltage Drain Current | V _{DS} = 800 V, V _{GS} = 0 V | -- | -- | 1 | μA |
| | | V _{DS} = 6400 V, T _C = 125°C | -- | -- | 10 | μA |
| I _{GSSF} | Gate-Body Leakage Current, Forward | V _{GS} = 20 V, V _{DS} = 0 V | -- | -- | 10 | μA |
| I _{GSSR} | Gate-Body Leakage Current, Reverse | V _{GS} = -20 V, V _{DS} = 0 V | -- | -- | -10 | μA |
| On Characteristics | | | | | | |
| V _{GS(th)} | Gate Threshold Voltage | V _{DS} = V _{GS} , I _D = 250 μA | 2.0 | -- | 4.0 | V |
| R _{DS(on)} | Static Drain-Source On-Resistance | V _{GS} = 10 V, I _D = 5 A | -- | 0.85 | 1.1 | Ω |
| g _{FS} | Forward Transconductance | V _{DS} = 40 V, I _D = 5 A (Note 4) | -- | 10.0 | -- | S |
| Dynamic Characteristics | | | | | | |
| C _{iss} | Input Capacitance | V _{DS} = 25 V, V _{GS} = 0 V, f = 1.0 MHz | -- | 2230 | -- | pF |
| C _{oss} | Output Capacitance | | -- | 135 | -- | pF |
| C _{riss} | Reverse Transfer Capacitance | | -- | 74 | -- | pF |
| Switching Characteristics | | | | | | |
| t _{d(on)} | Turn-On Delay Time | V _{DD} = 400 V, I _D = 10 A, R _G = 25 Ω (Note 4, 5) | -- | 25 | -- | ns |
| t _r | Turn-On Rise Time | | -- | 35 | -- | ns |
| t _{d(off)} | Turn-Off Delay Time | | -- | 225 | -- | ns |
| t _f | Turn-Off Fall Time | | -- | 145 | -- | ns |
| Q _g | Total Gate Charge | V _{DS} = 640 V, I _D = 10 A, V _{GS} = 10 V (Note 4, 5) | -- | 63 | -- | nC |
| Q _{gs} | Gate-Source Charge | | -- | 10 | -- | nC |
| Q _{gd} | Gate-Drain Charge | | -- | 25 | -- | nC |
| Drain-Source Diode Characteristics and Maximum Ratings | | | | | | |
| I _S | Maximum Continuous Drain-Source Diode Forward Current | | -- | -- | 9 | A |
| I _{SM} | Maximum Pulsed Drain-Source Diode Forward Current | | -- | -- | 36 | A |
| V _{SD} | Drain-Source Diode Forward Voltage | V _{GS} = 0 V, I _S = 10 A | -- | -- | 1.4 | V |
| t _{rr} | Reverse Recovery Time | V _{GS} = 0 V, I _S = 10 A, | -- | 850 | -- | ns |
| Q _{rr} | Reverse Recovery Charge | dI _F / dt = 100 A/μs (Note 4) | -- | 10 | -- | μC |

Notes:

1. Repetitive Rating : Pulse width limited by maximum junction temperature
2. L = 6.3mH, I_{AS} = 10A, V_{DD} = 50V, R_G = 25Ω, Starting T_J = 25°C
3. I_{SD} 9A, di/dt 200A/μs, V_{DD} BV_{DSS}, Starting T_J = 25°C
4. Pulse Test : Pulse width 300μs, Duty cycle 2%
5. Essentially independent of operating temperature

Typical Characteristics

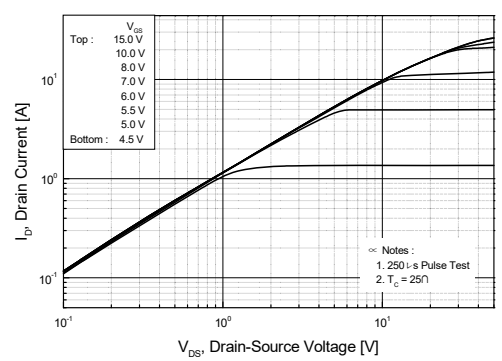

Figure 1. On-Region Characteristics

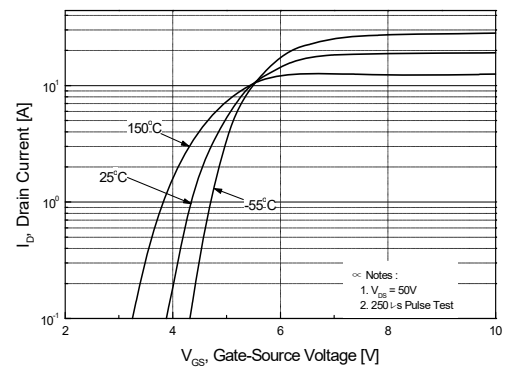

Figure 2. Transfer Characteristics

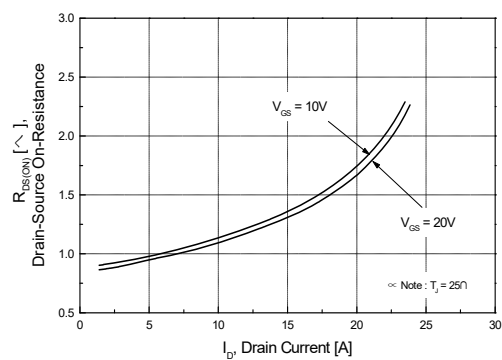

Figure 3. On-Resistance Variation vs Drain Current and Gate Voltage

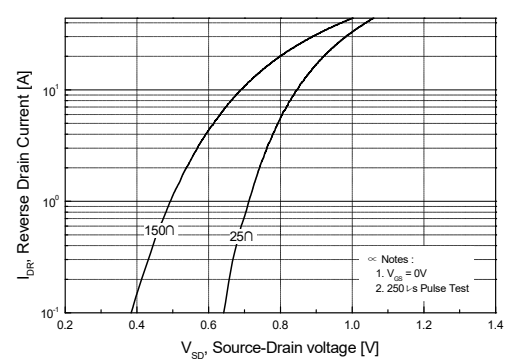

Figure 4. Body Diode Forward Voltage Variation with Source Current and Temperature

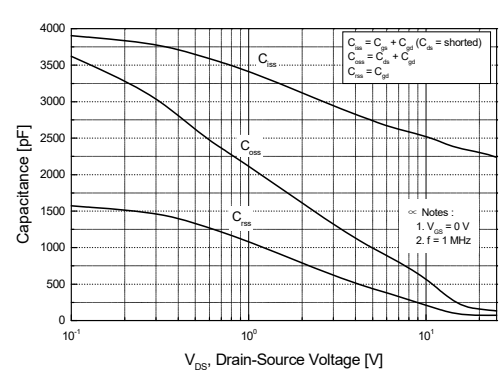

Figure 5. Capacitance Characteristics

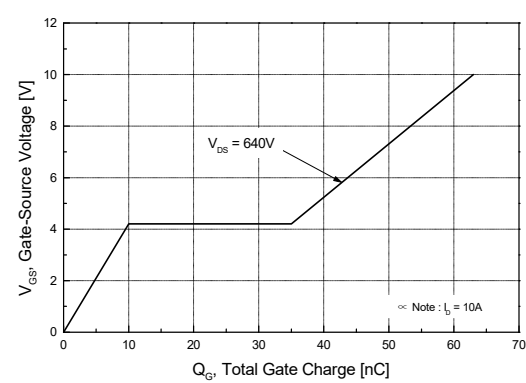

Figure 6. Gate Charge Characteristics

Typical Characteristics (Continued)

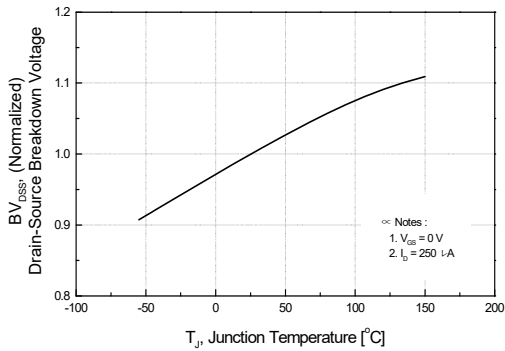

Figure 7. Breakdown Voltage Variation vs Temperature

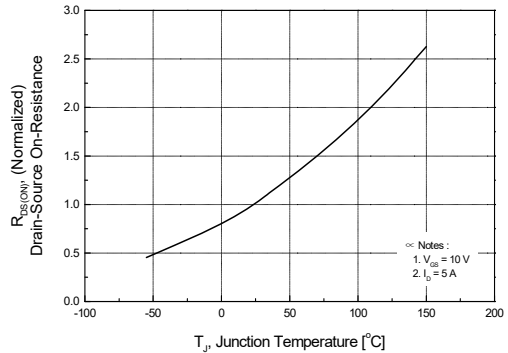

Figure 8. On-Resistance Variation vs Temperature

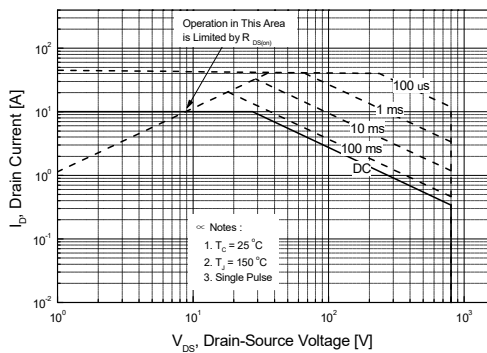

Figure 9-1. Maximum Safe Operating Area For SLP10N80CZ

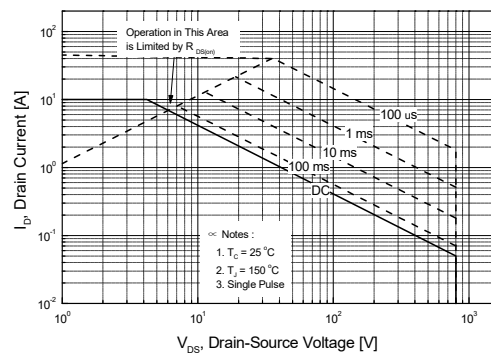

Figure 9-2. Maximum Safe Operating Area For SLF10N80CZ

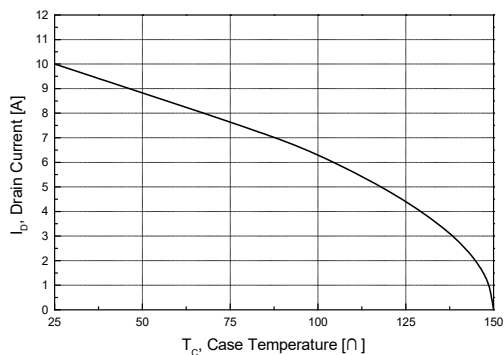

Figure 10. Maximum Drain Current vs Case Temperature

Typical Characteristics (Continued)

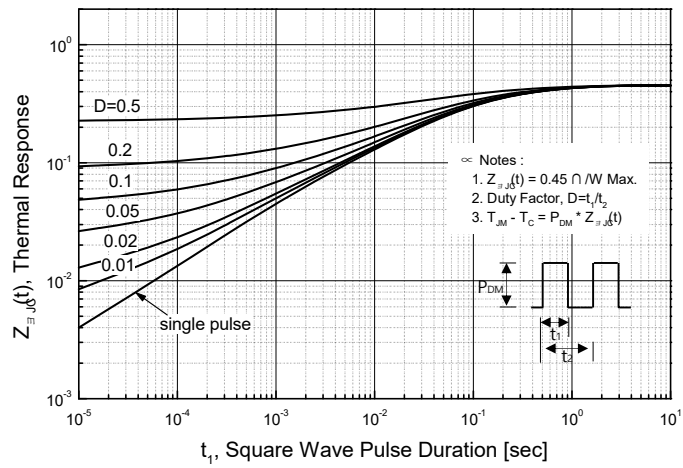

Figure 11-1. Transient Thermal Response Curve for SLP10N80CZ

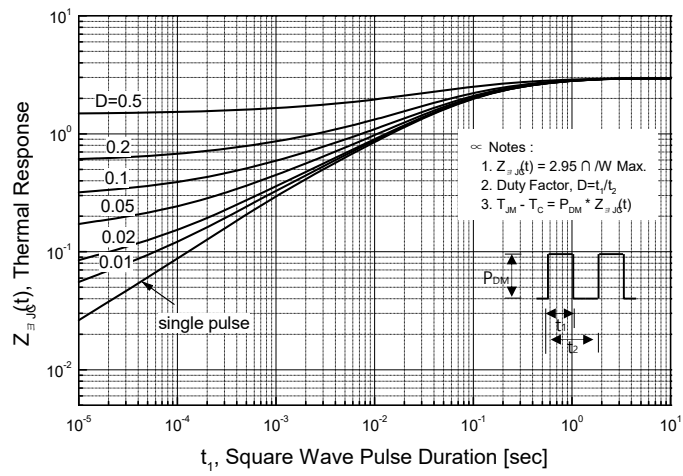
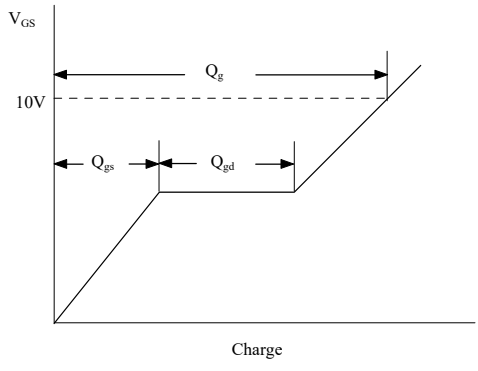
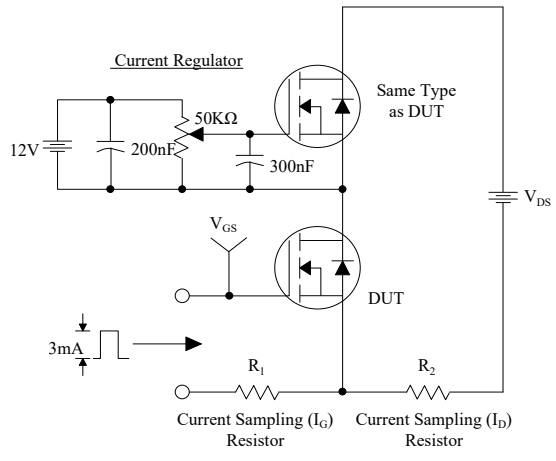
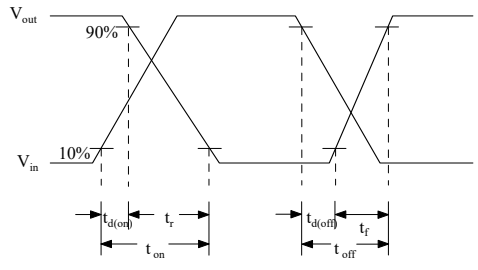
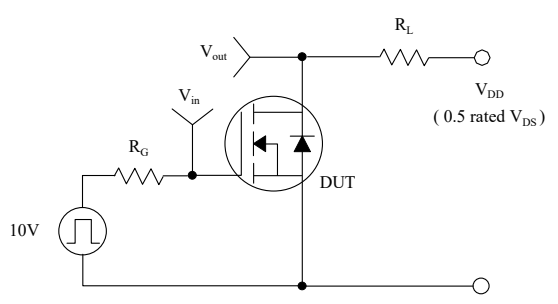

Figure 11-2. Transient Thermal Response Curve for SLF10N80CZ

Gate Charge Test Circuit & Waveform



Resistive Switching Test Circuit & Waveforms



Unclamped Inductive Switching Test Circuit & Waveforms

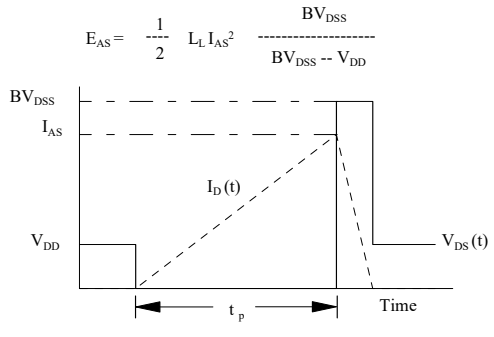
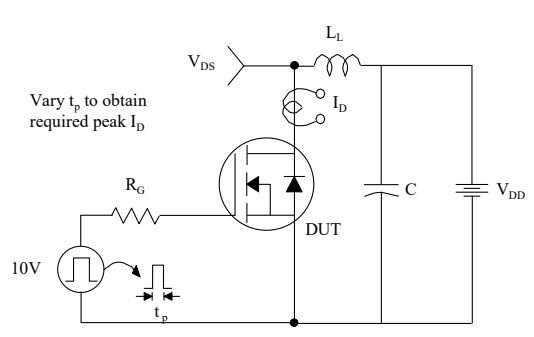

Peak Diode Recovery dv/dt Test Circuit & Waveforms

