

## General Description

This Power MOSFET is produced using Maple semi's Advanced Super-Junction technology.

This advanced technology has been especially tailored to minimize conduction loss, provide superior switching performance, and withstand high energy pulse in the avalanche and commutation mode.

These devices are well suited for AC/DC power conversion

## Features

- 10A, 800V, RDS(on) typ.= 0.55Ω@VGS = 10 V
- Low gate charge ( typical 35nC)
- High ruggedness
- Fast switching
- 100% avalanche tested
- Improved dv/dt capability

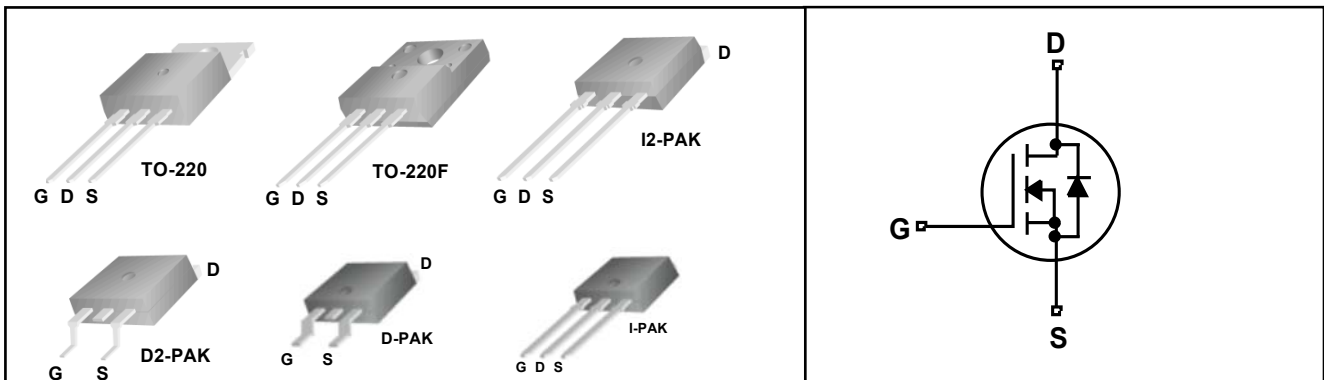

## Absolute Maximum Ratings

TC = 25°C unless otherwise noted

Symbol	Parameter	D2-PAK/D-PAK I2-PAK / I-PAK/ TO-220	TO-220F	Units
VDSS	Drain-Source Voltage	800		V
ID	Drain Current	- Continuous (TC = 25°C)	10	10*
		- Continuous (TC = 100°C)	6	6*
IDM	Drain Current - Pulsed (Note 1)	26	26*	A
VGSS	Gate-Source Voltage	±30		V
EAS	Single Pulsed Avalanche Energy (Note 2)	120		mJ
IAR	Avalanche Current (Note 1)	2		A
EAR	Repetitive Avalanche Energy (Note 1)	0.32		mJ
dv/dt	Peak Diode Recovery dv/dt (Note 3)	15		V/ns
PD	Power Dissipation (TC = 25°C)	83	31	W
		- Derate above 25°C	0.67	0.25
TJ, TSTG	Operating and Storage Temperature Range	-55 to +150		°C
TL	Maximum lead temperature for soldering purposes, 1/8" from case for 5 seconds	300		°C

\*Drain current limited by maximum junction temperature.

## Thermal Characteristics

Symbol	Parameter	Value						Units
		DPAK	IPAK	TO220	D2PAK	I2PAK	TO220F	
RθJC	Thermal Resistance, Junction-to-Case	1.5	1.5	1.5	1.5	1.5	4.0	°C/W
RθJS	Thermal Resistance, Case-to-Sink Typ.	-	-	0.5	0.5	0.5	-	°C/W
RθJA	Thermal Resistance, Junction-to-Ambient	62	62	62	62	62	80	°C/W

**Electrical Characteristics** ( TC = 25 °C unless otherwise noted )

Symbol	Parameter	Test Conditions	Min	Typ	Max	Units
<b>Off Characteristics</b>						
BVDSS	Drain-Source Breakdown Voltage	VGS = 0V, ID = 250uA, TJ=25°C	800	-	-	V
		VGS = 0V, ID = 250uA, TJ=150°C	-	850	-	V
$\Delta$ BVDSS $\Delta$ TJ	Breakdown Voltage Temperature coefficient	ID = 250uA, referenced to 25°C	-	0.6	-	V/°C
IDSS	Drain-Source Leakage Current	VDS =800V, VGS = 0V	-	-	1	uA
		VDS =640V, TC = 125 °C	-	10	-	uA
IGSS	Gate-Source Leakage, Forward	VGS = 30V, VDS = 0V	-	-	100	nA
	Gate-source Leakage, Reverse	VGS = -30V, VDS = 0V	-	-	-100	nA

**On Characteristics**

VGS(th)	Gate Threshold Voltage	VDS = VGS, ID = 250uA	2.5	3.5	4.5	V
RDS(ON)	Static Drain-Source On-state Resistance	VGS =10 V, ID = 5A	-	0.55	0.6	$\Omega$

**Dynamic Characteristics**

Ciss	Input Capacitance	VGS =0 V, VDS =25V, f = 1MHz	-	550	-	pF
Coss	Output Capacitance		-	140	-	
Crss	Reverse Transfer Capacitance		-	7	-	

**Dynamic Characteristics**

td(on)	Turn-on Delay Time	VDD =400V, ID =5.0A, RG =20 $\Omega$	-	15	-	nS
tr	Rise Time		-	10	-	
td(off)	Turn-off Delay Time		-	110	-	
tf	Fall Time		-	9	-	
Qg	Total Gate Charge	VDS =480V, VGS =10V, ID =5.0A	-	35	-	nC
Qgs	Gate-Source Charge		-	3.8	-	
Qgd	Gate-Drain Charge(Miller Charge)		-	4	-	

**Source-Drain Diode Ratings and Characteristics**

Symbol	Parameter	Test Conditions	Min.	Typ.	Max.	Unit.
IS	Maximum Continuous Drain-Source Diode Forward Current		-	-	10	A
ISM	Maximum Pulsed Drain-Source Diode Forward Current		-	-	26	
VSD	Diode Forward Voltage	IS =5.0A, VGS =0V	-	-	1.5	V
trr	Reverse Recovery Time	IS =5.0A, VGS=0V, dIF/dt=100A/us	-	240	-	nS
Qrr	Reverse Recovery Charge		-	3.1	-	uC

**NOTES**

1. Repetitive Rating: Pulse width limited by maximum junction temperature
2. IAS=2A, VDD=50V, Starting TJ=25 °C
3. ISD $\leq$ ID, di/dt  $\leq$  200A/us, VDD  $\leq$  BVDSS, Starting TJ = 25 °C
4. Essentially Independent of Operating Temperature Typical Characteristics

### Typical Performance Characteristics

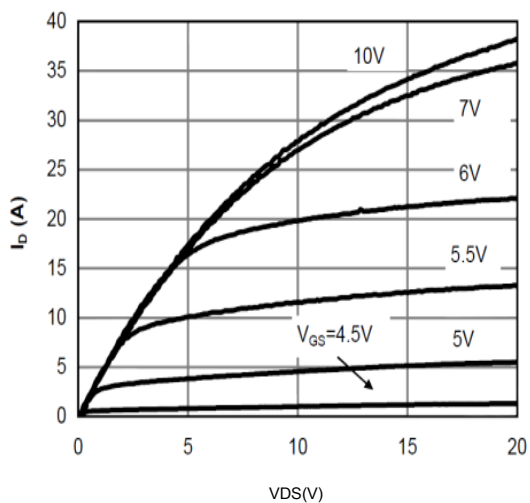

Figure 1: On-Region Characteristics@25°C

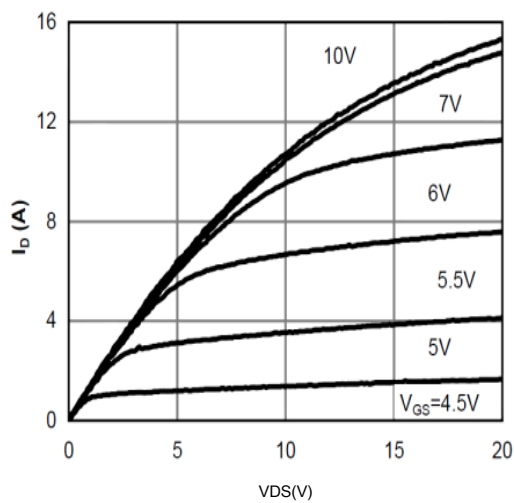

Figure 2: On-Region Characteristics@125°C

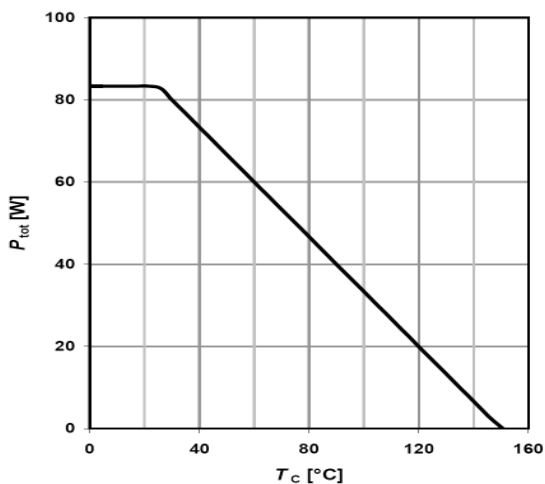

Figure 3: Power Dissipation

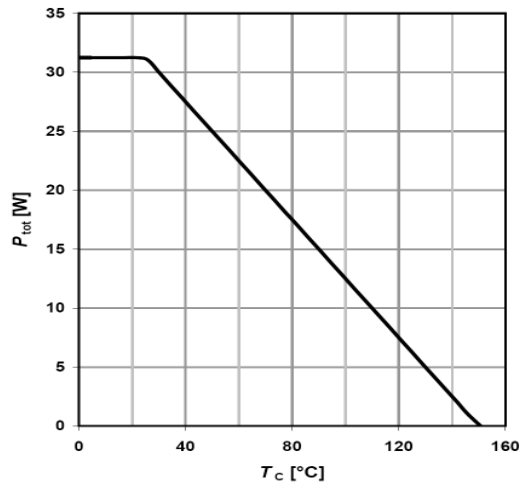

Figure 4: Power Dissipation

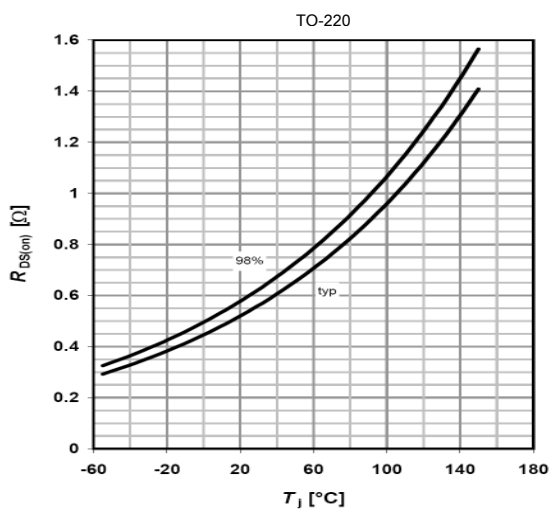

Figure 5: On-Resistance vs. Junction Temperature

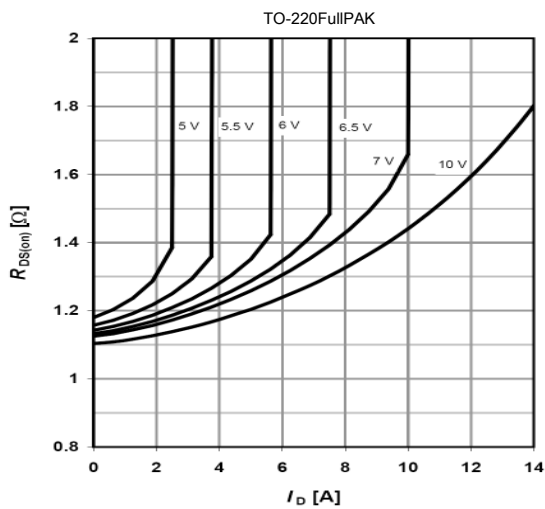

Figure 6: On-Resistance vs. Drain Current,  $T_j=125^\circ\text{C}$

## Typical Performance Characteristics

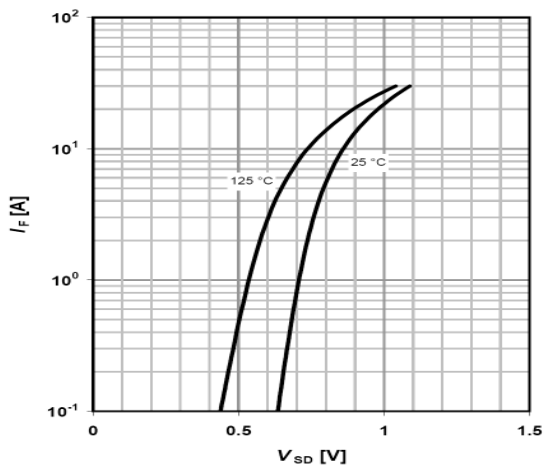

Figure 7: Body-Diode Characteristics

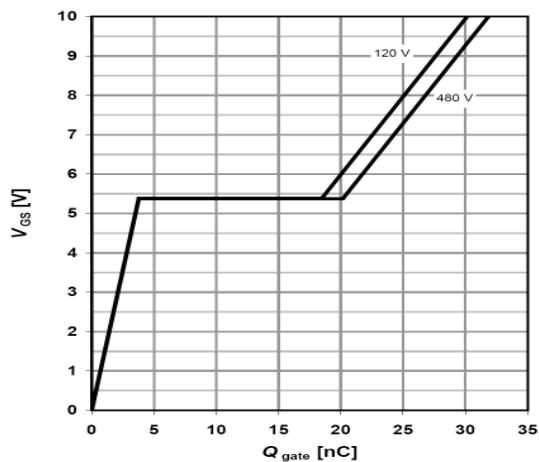

Figure 8: Gate-Charge Characteristics

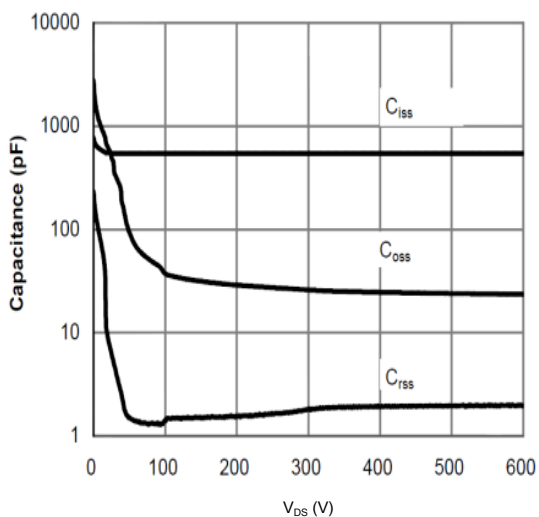

Figure 9: Capacitance Characteristics

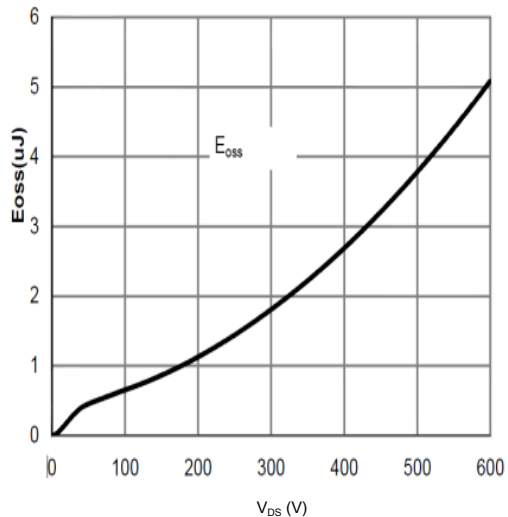

Figure 10:  $C_{oss}$  stored Energy

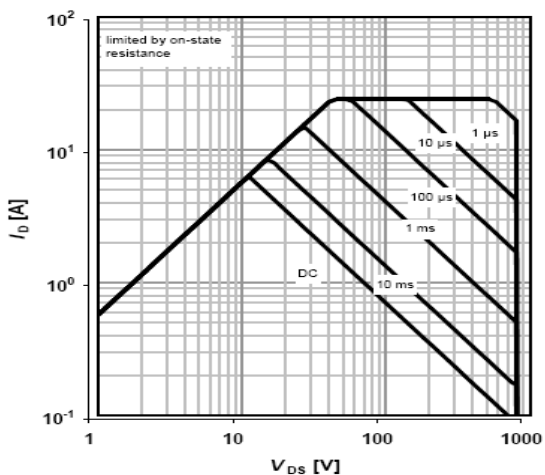

Figure 11: Maximum Forward Biased Safe Operating Area

TO-220,  $T_c=25^\circ\text{C}$

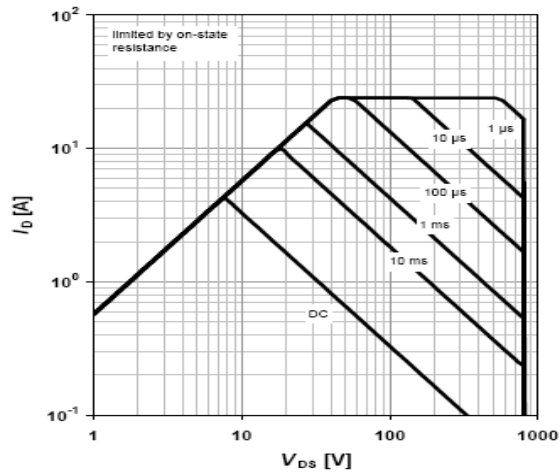

Figure 12: Maximum Forward Biased Safe Operating Area

TO-220 FullPAK,  $T_c=25^\circ\text{C}$

## Typical Performance Characteristics

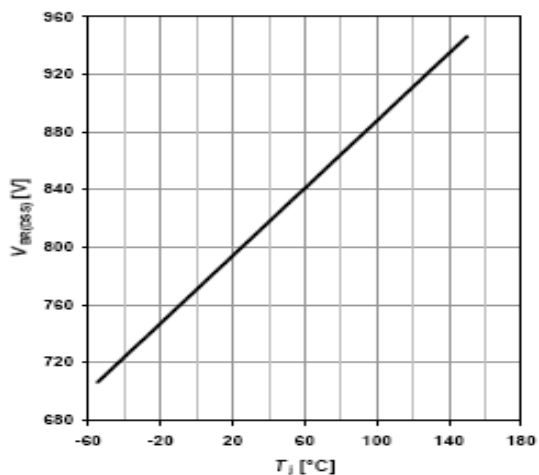

Figure 13: Break Down vs. Junction Temperature

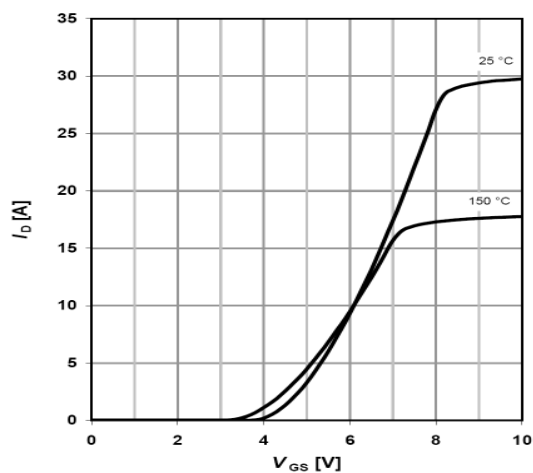

Figure 14: Typical transfer characteristics

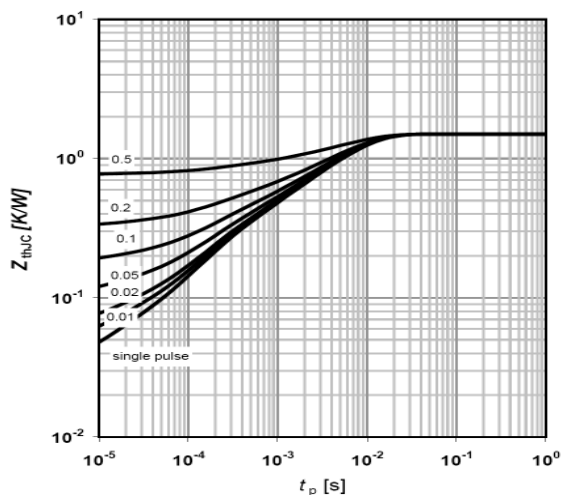

Figure 15: Maximum Transient Thermal Impedance

TO-220

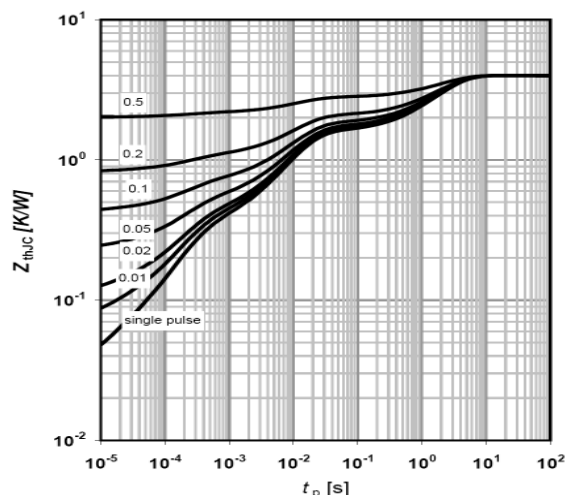

Figure 16: Maximum Transient Thermal Impedance

TO-220 FullPAK

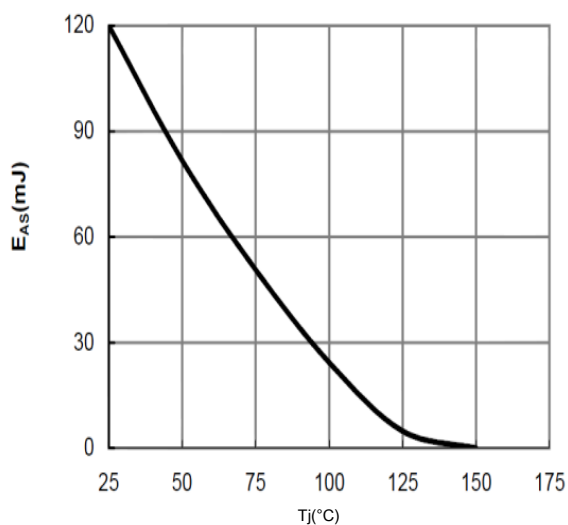
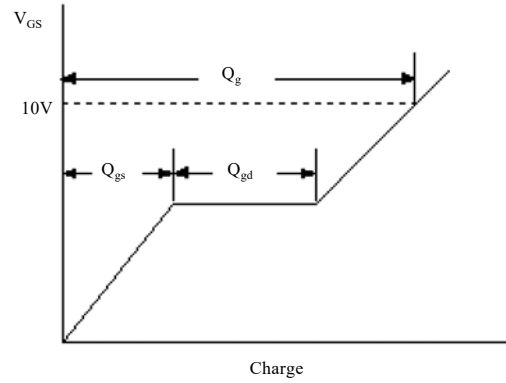
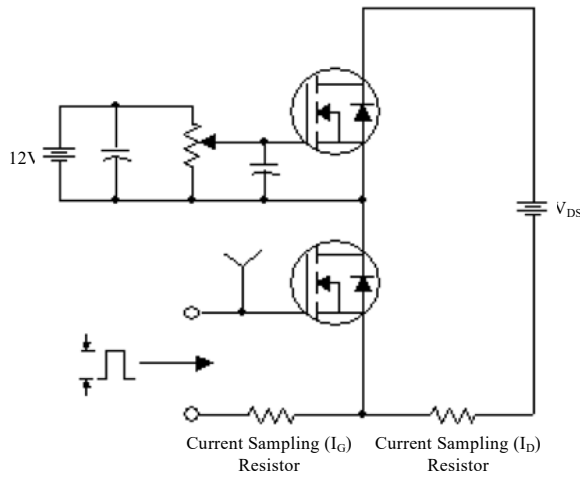
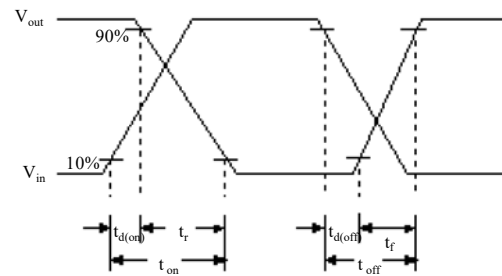
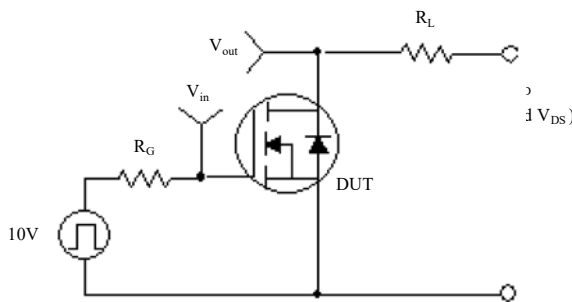

Figure 17: Avalanche energy

### Gate Charge Test Circuit & Waveform



### Resistive Switching Test Circuit & Waveforms



### Unclamped Inductive Switching Test Circuit & Waveforms

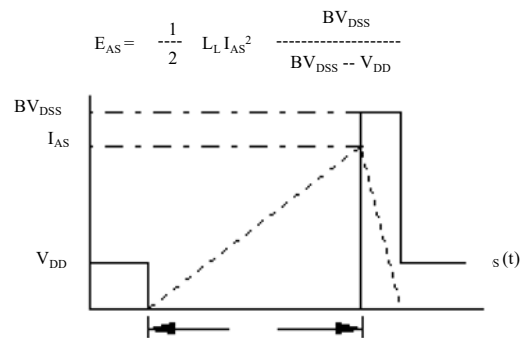
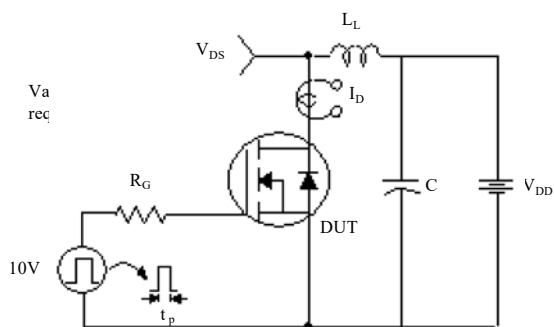

### Peak Diode Recovery dv/dt Test Circuit & Waveforms

