



CB-FET

SLD50R550SJ/SLU50R550SJ 500V N-Channel MOSFET

SLD50R550SJ/SLU50R550SJ

General Description

This Power MOSFET is produced using Maple semi's Advanced Super-Junction technology. This advanced technology has been especially tailored to minimize conduction loss, provide superior switching performance, and withstand high energy pulse in the avalanche and commutation mode. These devices are well suited for AC/DC power conversion in switching mode operation for higher efficiency.

Features

- 7.6A, 500V, $R_{DS(on) typ.} = 0.5\Omega @ V_{GS} = 10V$
- Low gate charge (typical 25nC)
- High ruggedness
- Fast switching
- 100% avalanche tested
- Improved dv/dt capability

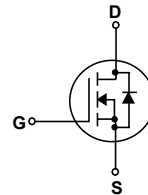
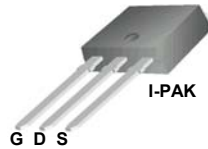
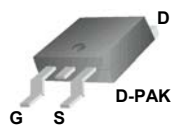

Absolute Maximum Ratings $T_C = 25^\circ\text{C}$ unless otherwise noted

Symbol	Parameter	SLD50R550SJ/SLU50R550SJ	Units
V_{DSS}	Drain-Source Voltage	500	V
I_D	Drain Current - Continuous ($T_C = 25^\circ\text{C}$) - Continuous ($T_C = 100^\circ\text{C}$)	7.6*	A
		5*	A
I_{DM}	Drain Current - Pulsed (Note 1)	10	A
V_{GSS}	Gate-Source Voltage	± 30	V
EAS	Single Pulsed Avalanche Energy (Note 2)	86	mJ
I_{AR}	Avalanche Current (Note 1)	1.7	A
E_{AR}	Repetitive Avalanche Energy (Note 1)	43	mJ
dv/dt	Peak Diode Recovery dv/dt (Note 3)	4.5	V/ns
P_D	Power Dissipation ($T_C = 25^\circ\text{C}$) - Derate above 25°C	57	W
		0.45	W/ $^\circ\text{C}$
T_J, T_{STG}	Operating and Storage Temperature Range	-55 to +150	$^\circ\text{C}$
T_L	Maximum lead temperature for soldering purposes, 1/8" from case for 5 seconds	300	$^\circ\text{C}$

* Drain current limited by maximum junction temperature.

Thermal Characteristics

Symbol	Parameter	SLD50R550SJ/SLU50R550SJ	Units
$R_{\theta JC}$	Thermal Resistance, Junction-to-Case	2.2	$^\circ\text{C}/\text{W}$
$R_{\theta JS}$	Thermal Resistance, Case-to-Sink Typ.	0.5	$^\circ\text{C}/\text{W}$
$R_{\theta JA}$	Thermal Resistance, Junction-to-Ambient	62	$^\circ\text{C}/\text{W}$

Electrical CharacteristicsT_C = 25°C unless otherwise noted

Symbol	Parameter	Test Conditions	Min	Typ	Max	Units
Off Characteristics						
BV _{DSS}	Drain-Source Breakdown Voltage	V _{GS} = 0 V, I _D = 250 μA, T _J =25°C	500	--	--	V
		V _{GS} = 0 V, I _D = 250 μA, T _J =150°C	--	550	--	V
ΔBV _{DSS} / ΔT _J	Breakdown Voltage Temperature Coefficient	I _D = 250 μA, Referenced to 25°C	--	0.6	--	V/°C
I _{DSS}	Zero Gate Voltage Drain Current	V _{DS} = 500 V, V _{GS} = 0 V	--	--	1	μA
		V _{DS} = 480 V, T _C = 125°C	--	--	10	μA
I _{GSSF}	Gate-Body Leakage Current, Forward	V _{GS} = 30 V, V _{DS} = 0 V	--	--	100	nA
I _{GSSR}	Gate-Body Leakage Current, Reverse	V _{GS} = -30 V, V _{DS} = 0 V	--	--	-100	nA
On Characteristics						
V _{GS(th)}	Gate Threshold Voltage	V _{DS} = V _{GS} , I _D = 250 μA	2.5	3.5	4.5	V
R _{DS(on)}	Static Drain-Source On-Resistance	V _{GS} = 10 V, I _D = 3.5 A	--	0.5	0.55	Ω
g _{FS}	Forward Transconductance	V _{DS} = 40 V, I _D = 3.5 A (Note 4)	--	16	--	S
Dynamic Characteristics						
C _{iss}	Input Capacitance	V _{DS} = 25 V, V _{GS} = 0 V, f = 1.0 MHz	--	360	--	pF
C _{oss}	Output Capacitance		--	25	--	pF
C _{rss}	Reverse Transfer Capacitance		--	1.2	--	pF
Switching Characteristics						
t _{d(on)}	Turn-On Delay Time	V _{DD} = 400 V, I _D = 3.5 A, R _G = 20 Ω (Note 4, 5)	--	25	--	ns
t _r	Turn-On Rise Time		--	55	--	ns
t _{d(off)}	Turn-Off Delay Time		--	70	--	ns
t _f	Turn-Off Fall Time		--	40	--	ns
Q _g	Total Gate Charge	V _{DS} = 480 V, I _D = 7 A, V _{GS} = 10 V (Note 4, 5)	--	8	--	nC
Q _{gs}	Gate-Source Charge		--	2.0	--	nC
Q _{gd}	Gate-Drain Charge		--	2.7	--	nC
Drain-Source Diode Characteristics and Maximum Ratings						
I _S	Maximum Continuous Drain-Source Diode Forward Current		--	--	7	A
I _{SM}	Maximum Pulsed Drain-Source Diode Forward Current		--	--	18	A
V _{SD}	Drain-Source Diode Forward Voltage	V _{GS} = 0 V, I _S = 7 A	--	--	1.5	V
t _{rr}	Reverse Recovery Time	V _{GS} = 0 V, I _S = 7 A,	--	190	--	ns
Q _{rr}	Reverse Recovery Charge	dI _F / dt = 100 A/μs (Note 4)	--	2.3	--	μC

NOTES:

1. Repetitive Rating: Pulse width limited by maximum junction temperature
2. L=60mH, I_{AS}=1.7A, V_{DD}=150V, Starting T_J=25 °C
3. I_{GD}≤7A, di/dt ≤ 200A/μs, V_{DD} ≤ BV_{DSS}, Starting T_J = 25 °C
4. Pulse Test: Pulse width ≤ 300μs, Duty Cycle ≤ 2%
5. Essentially Independent of Operating Temperature Typical Characteristics

Typical Characteristics

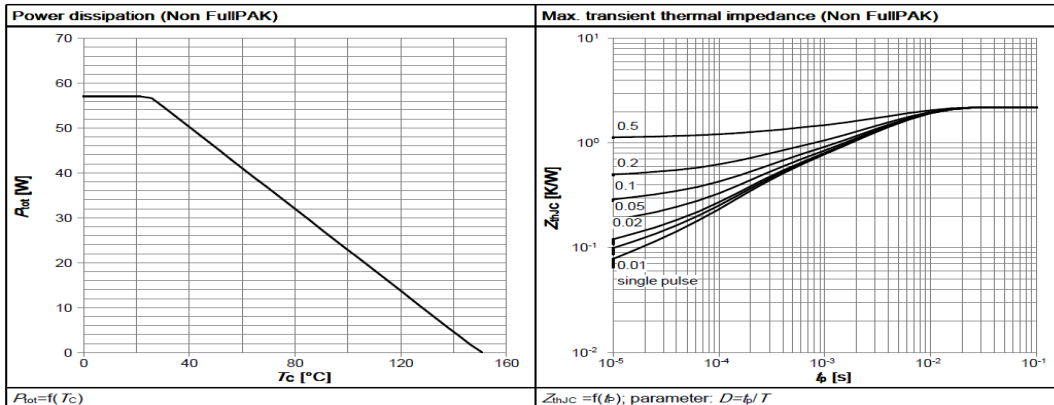

Figure 1: Power Dissipation

Figure 2: Transient Thermal Impedance

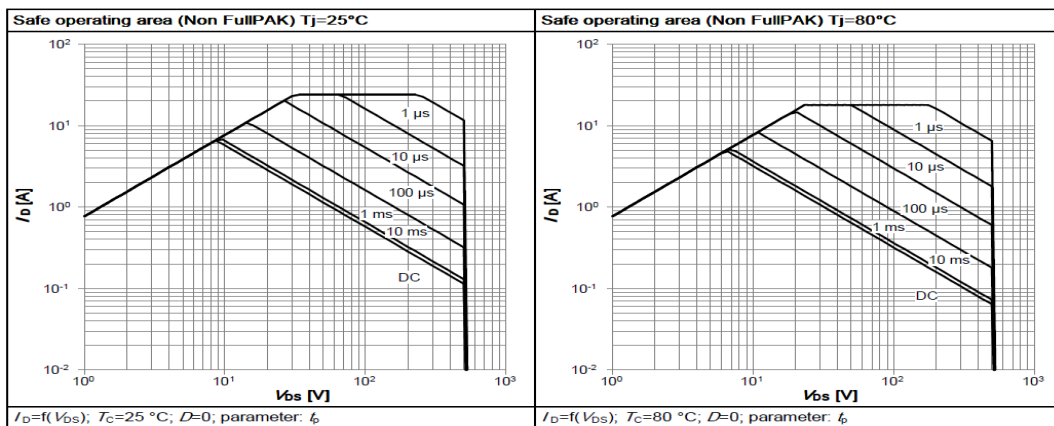

Figure 3: Safe Operating Area@25°C

Figure 4: Safe Operating Area@80°C

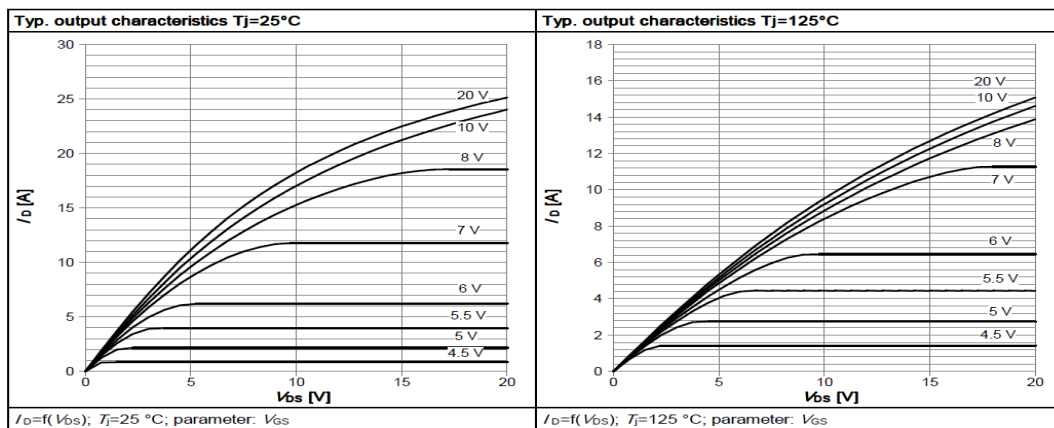

Figure 5: Output Characteristics@25°C

Figure 6: Output Characteristics@125°C

Typical Characteristics

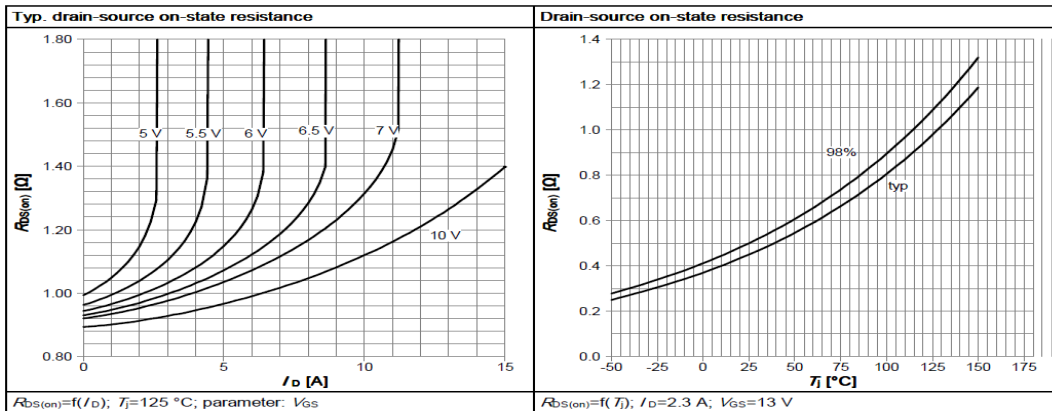

Figure 7: On-Resistance vs. Drain Current

Figure 8: On-Resistance vs. Temperatures

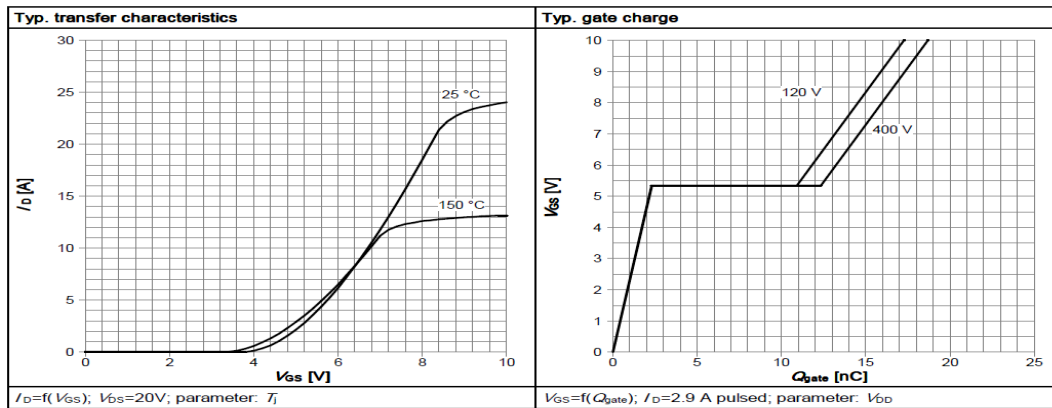

Figure 9: Transfer Characteristics

Figure 10: Gata Charge

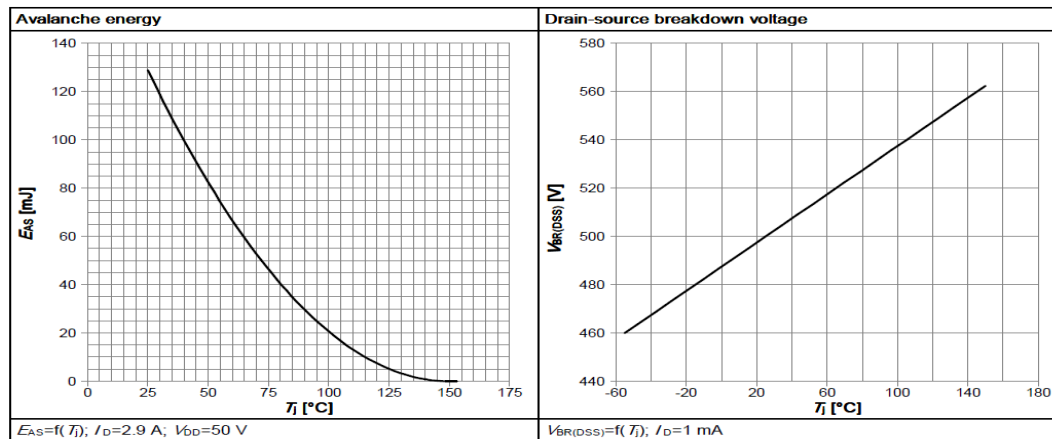

Figure 11: Avalanche Energy

Figure 12: Drain-Source Breakdown Voltage

Typical Characteristics

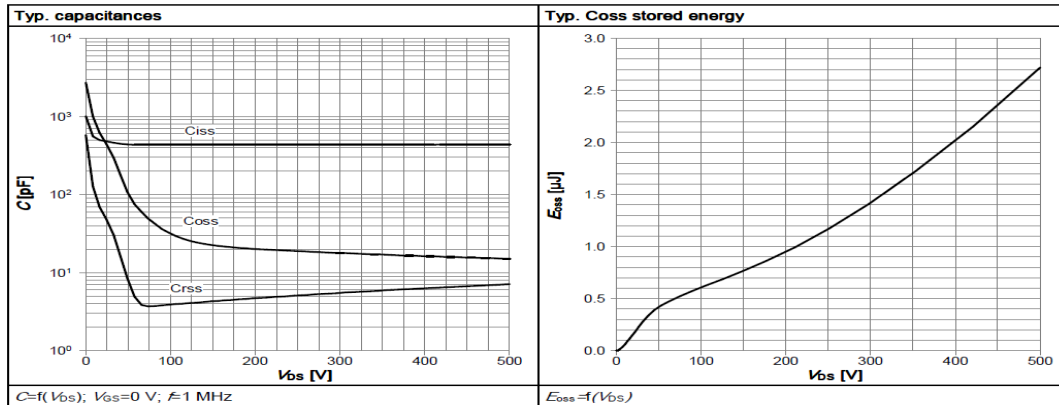

Figure 13: Capacitances

Figure 14: Coss Stored Energy

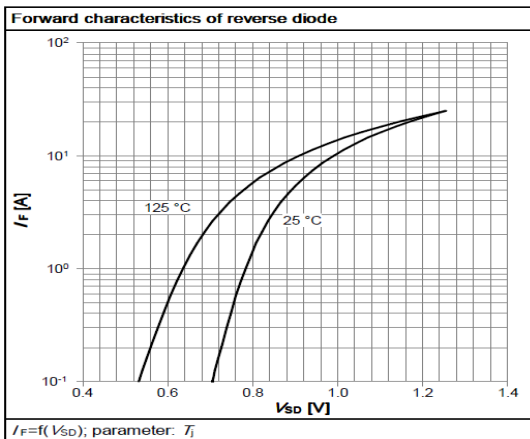
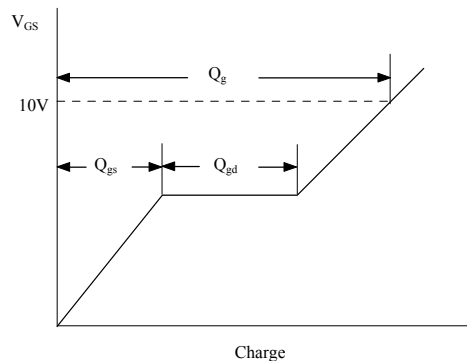
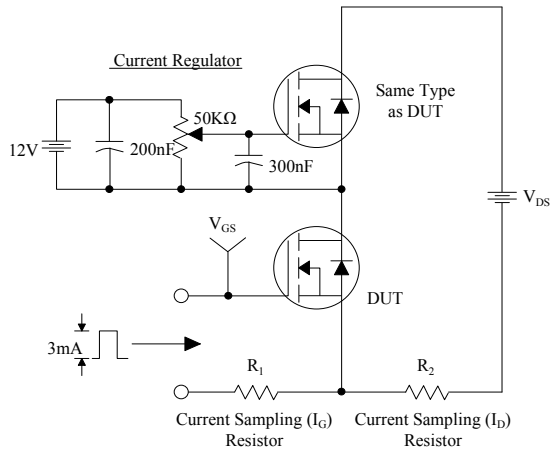
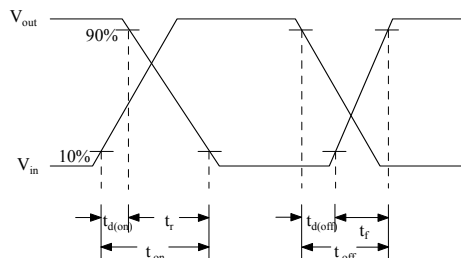
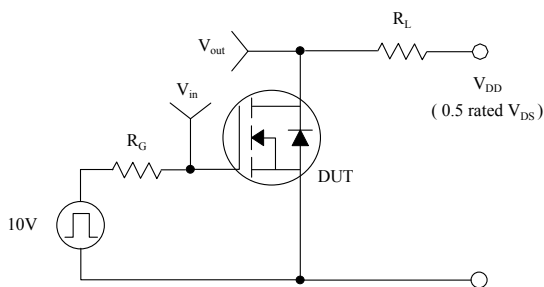

Figure 15: Forward Characteristics Of Reverse Diode

Gate Charge Test Circuit & Waveform



Resistive Switching Test Circuit & Waveforms



Unclamped Inductive Switching Test Circuit & Waveforms

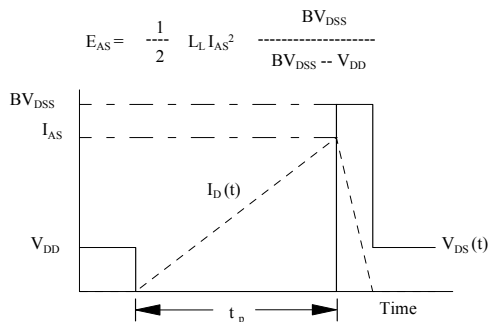
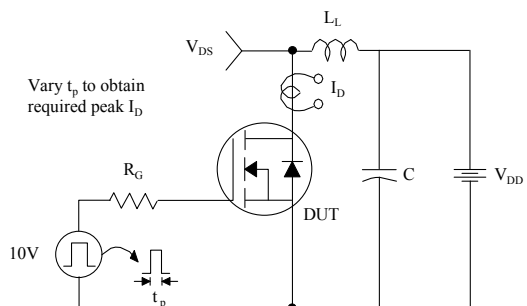

Peak Diode Recovery dv/dt Test Circuit & Waveforms

