

TOSHIBA BI-DIRECTIONAL TRIODE THYRISTOR SILICON PLANAR TYPE

## SM2GZ47, SM2GZ47A, SM2JZ47, SM2JZ47A

### AC POWER CONTROL APPLICATIONS

- $I_T$  (RMS) = 1A ( $T_a = 65^\circ\text{C}$  without radiator)
- Gate Trigger Current:  $I_{GT} = 5\text{mA Max. (TYPE "A")}$
- Repetitive Peak Off-State Voltage:  $V_{DRM} = 400\text{V, } 600\text{V}$
- R.M.S On-State Current:  $I_T$  (RMS) = 2A ( $T_c = 110^\circ\text{C}$ )
- Isolation Voltage:  $V_{ISOL} = 1500\text{V (AC, } t = 60\text{s)}$

### ABSOLUTE MAXIMUM RATINGS

CHARACTERISTIC	SYMBOL	RATING	UNIT
Repetitive Peak Off-State Voltage and Repetitive Peak Reverse Voltage	SM2GZ47 SM2GZ47A	400	V
	SM2JZ47 SM2JZ47A	600	
R.M.S On-State Current (Full Sine Waveform)	$T_c = 110^\circ\text{C}$	2	A
	$T_a = 65^\circ\text{C}$	1	
Peak One Cycle Surge On-State Current (Non-Repetitive)	$I_{TSM}$	8 (50Hz)	A
		8.8 (60Hz)	
I2t Limit Value	I2t	0.32	A2s
Peak Gate Power Dissipation	$P_{GM}$	3	W
Average Gate Power Dissipation	$P_G$ (AV)	0.3	W
Peak Gate Voltage	$V_{FGM}$	10	V
Peak Gate Current	$I_{GM}$	1.6	A
Junction Temperature	$T_j$	-40~125	$^\circ\text{C}$
Storage Temperature Range	$T_{stg}$	-40~125	$^\circ\text{C}$
Isolation Voltage (AC, $t = 1\text{min.}$ )	$V_{ISOL}$	1500	V

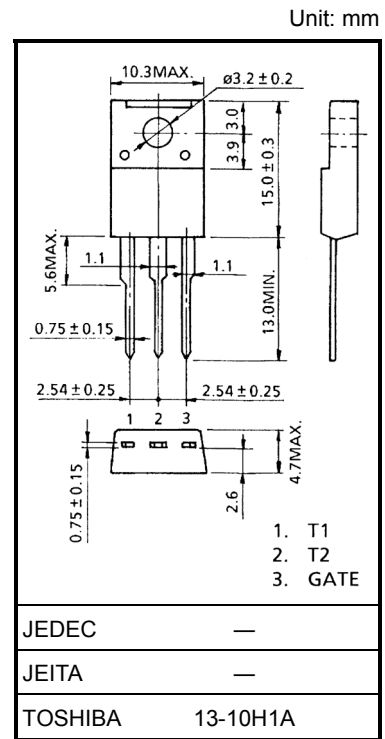

Weight: 1.7 g (typ.)

Note: Using continuously under heavy loads (e.g. the application of high temperature/current/voltage and the significant change in temperature, etc.) may cause this product to decrease in the reliability significantly even if the operating conditions (i.e. operating temperature/current/voltage, etc.) are within the absolute maximum ratings.

Please design the appropriate reliability upon reviewing the Toshiba Semiconductor Reliability Handbook ("Handling Precautions"/Derating Concept and Methods) and individual reliability data (i.e. reliability test report and estimated failure rate, etc).

### MARKING

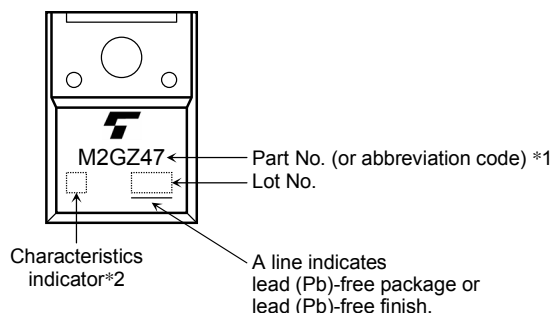

	Part No. (or abbreviation code)	Part No.
*1	M2GZ47	SM2GZ47, SM2GZ47A
	M2JZ47	SM2JZ47, SM2JZ47A
*2	Nothing	SM2GZ47, SM2JZ47
	A	SM2GZ47A, SM2JZ47A

### ELECTRICAL CHARACTERISTICS (Ta = 25°C)

CHARACTERISTIC		SYMBOL	TEST CONDITION	MIN	TYP.	MAX	UNIT		
Repetitive Peak Off-State Current		$I_{DRM}$	$V_{DRM} = \text{Rated}$	—	—	20	$\mu\text{A}$		
Gate Trigger Voltage	I	$V_{GT}$	$V_D = 12\text{V}$ $R_L = 20\Omega$	T2 (+), Gate (+)	—	—	1.5	V	
	II			T2 (+), Gate (-)	—	—	1		
	III			T2 (-), Gate (-)	—	—	1		
	IV			T2 (-), Gate (+)	—	—	—		
Gate Trigger Current	SM2GZ47 SM2JZ47	$I_{GT}$	$V_D = 12\text{V}$ $R_L = 20\Omega$	T2 (+), Gate (+)	—	—	8	mA	
				II	T2 (+), Gate (-)	—	—		8
				III	T2 (-), Gate (-)	—	—		8
				IV	T2 (-), Gate (+)	—	—		—
	SM2GZ47A SM2JZ47A			I	T2 (+), Gate (+)	—	—		5
				II	T2 (+), Gate (-)	—	—		5
				III	T2 (-), Gate (-)	—	—		5
				IV	T2 (-), Gate (+)	—	—		—
Peak On-State Voltage		$V_{TM}$	$I_{TM} = 3\text{A}$	—	—	1.7	V		
Gate Non-Trigger Voltage		$V_{GD}$	$V_D = \text{Rated}, T_c = 125^\circ\text{C}$	0.2	—	—	V		
Holding Current		$I_H$	$R_L = 100\Omega$	—	—	10	mA		
Thermal Resistance		$R_{th(j-a)}$	Junction to Ambient, AC	—	—	55	$^\circ\text{C} / \text{W}$		

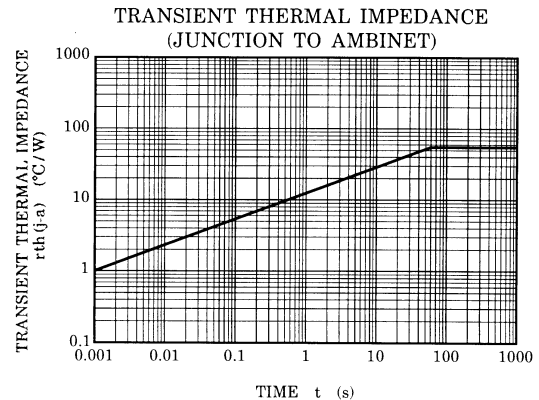
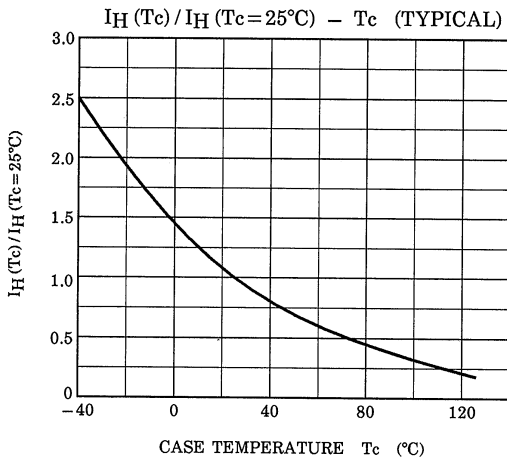
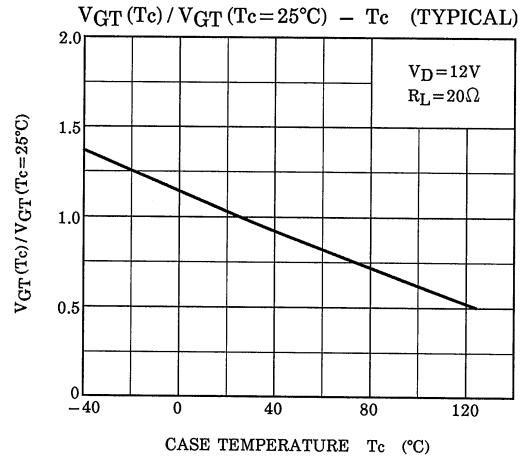
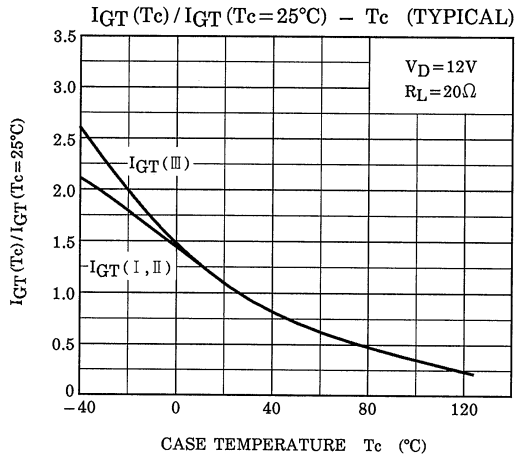
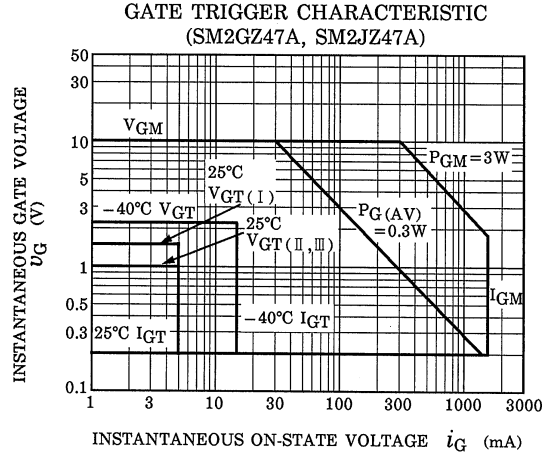
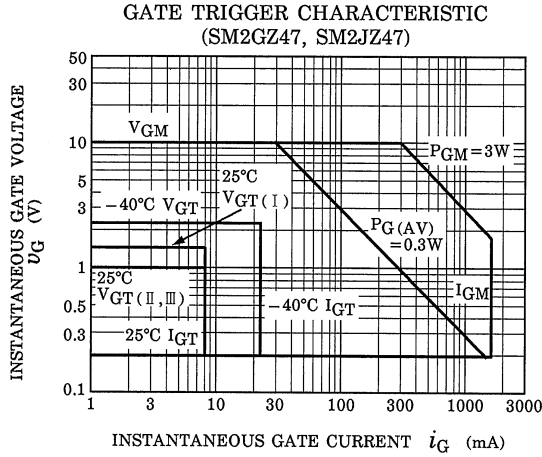

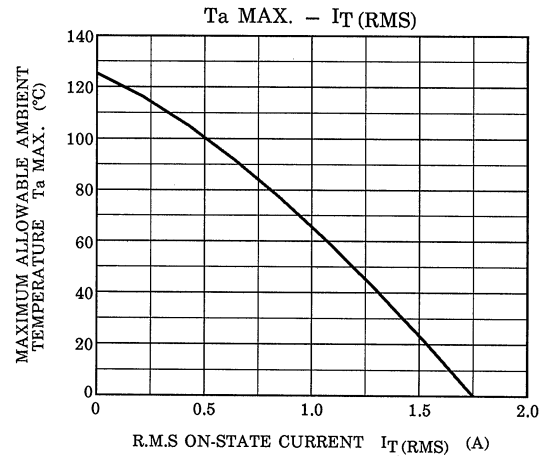
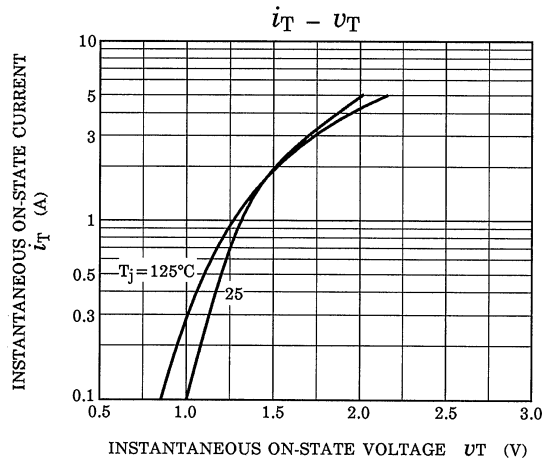

<CONDITION>

- ◆ NO HEAT SINK
- ◆ LEAD FORMING : LB182
- ◆ PRINT BOARD

$\left( \begin{array}{l} t=1.6\text{mm} \\ \text{SOLDER LAND : } 2\text{mm}\phi \end{array} \right)$

**RESTRICTIONS ON PRODUCT USE**

030619EAA

- The information contained herein is subject to change without notice.
- The information contained herein is presented only as a guide for the applications of our products. No responsibility is assumed by TOSHIBA for any infringements of patents or other rights of the third parties which may result from its use. No license is granted by implication or otherwise under any patent or patent rights of TOSHIBA or others.
- TOSHIBA is continually working to improve the quality and reliability of its products. Nevertheless, semiconductor devices in general can malfunction or fail due to their inherent electrical sensitivity and vulnerability to physical stress. It is the responsibility of the buyer, when utilizing TOSHIBA products, to comply with the standards of safety in making a safe design for the entire system, and to avoid situations in which a malfunction or failure of such TOSHIBA products could cause loss of human life, bodily injury or damage to property.  
In developing your designs, please ensure that TOSHIBA products are used within specified operating ranges as set forth in the most recent TOSHIBA products specifications. Also, please keep in mind the precautions and conditions set forth in the "Handling Guide for Semiconductor Devices," or "TOSHIBA Semiconductor Reliability Handbook" etc..
- The TOSHIBA products listed in this document are intended for usage in general electronics applications (computer, personal equipment, office equipment, measuring equipment, industrial robotics, domestic appliances, etc.). These TOSHIBA products are neither intended nor warranted for usage in equipment that requires extraordinarily high quality and/or reliability or a malfunction or failure of which may cause loss of human life or bodily injury ("Unintended Usage"). Unintended Usage include atomic energy control instruments, airplane or spaceship instruments, transportation instruments, traffic signal instruments, combustion control instruments, medical instruments, all types of safety devices, etc.. Unintended Usage of TOSHIBA products listed in this document shall be made at the customer's own risk.
- TOSHIBA products should not be embedded to the downstream products which are prohibited to be produced and sold, under any law and regulations.