

P-Channel Enhancement Mode MOSFET

Features

- 30V/-33A,
 $R_{DS(ON)} = 18m\Omega(\text{max.}) @ V_{GS} = -10V$
 $R_{DS(ON)} = 30m\Omega(\text{max.}) @ V_{GS} = -4.5V$
- Reliable and Rugged
- Lead Free and Green Devices Available (RoHS Compliant)

Pin Description

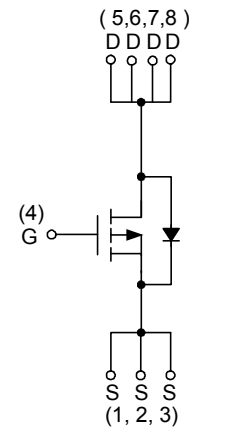
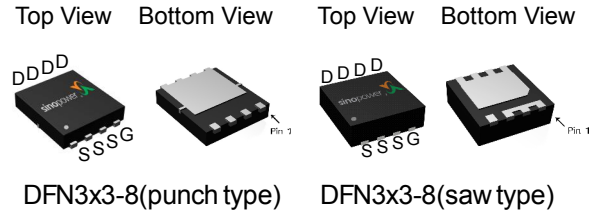

P-Channel MOSFET

Applications

- Power Management in Notebook Computer, Portable Equipment and Battery Powered Systems.

Ordering and Marking Information

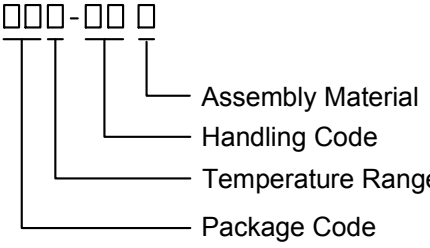
<p>SM3307PS □□□-□□□</p>  <p>Assembly Material Handling Code Temperature Range Package Code</p>	<p>Package Code QA : DFN3x3-8 (punch type) QG : DFN3x3-8 (saw type) Operating Junction Temperature Range C : -55 to 150 °C Handling Code TR : Tape & Reel (3000ea/reel) Assembly Material G : Halogen and Lead Free Device</p>
<p>SM3307PS QA/QG : SM 3307 XXXXX</p>	<p>XXXXX - Lot Code</p>

Note : SINOPOWER lead-free products contain molding compounds/die attach materials and 100% matte tin plate termination finish; which are fully compliant with RoHS. SINOPOWER lead-free products meet or exceed the lead-free requirements of IPC/JEDEC J-STD-020D for MSL classification at lead-free peak reflow temperature. SINOPOWER defines "Green" to mean lead-free (RoHS compliant) and halogen free (Br or Cl does not exceed 900ppm by weight in homogeneous material and total of Br and Cl does not exceed 1500ppm by weight).

SINOPOWER reserves the right to make changes to improve reliability or manufacturability without notice, and advise customers to obtain the latest version of relevant information to verify before placing orders.

Absolute Maximum Ratings $(T_A = 25^\circ\text{C}$ Unless Otherwise Noted)

Symbol	Parameter	Rating	Unit	
V_{DSS}	Drain-Source Voltage	-30	V	
V_{GSS}	Gate-Source Voltage	± 25		
I_D^a	Continuous Drain Current ($V_{GS}=-10V$)	$T_A=25^\circ\text{C}$	-11	
		$T_A=70^\circ\text{C}$	-8.5	
I_{DM}^a	300 μs Pulsed Drain Current ($V_{GS}=-10V$)	-80	A	
I_D^d	Continuous Drain Current ($V_{GS}=-10V$)	$T_C=25^\circ\text{C}$		-33
		$T_C=100^\circ\text{C}$		-21
I_S^a	Diode Continuous Forward Current	-3		
I_{AS}^b	Avalanche Current, Single pulse ($L=0.1\text{mH}$)	-24		
E_{AS}^b	Avalanche Energy, Single pulse ($L=0.1\text{mH}$)	29	mJ	
T_J	Maximum Junction Temperature	150	$^\circ\text{C}$	
T_{STG}	Storage Temperature Range	-55 to 150		
P_D^a	Maximum Power Dissipation	$T_A=25^\circ\text{C}$	3.1	
		$T_A=70^\circ\text{C}$	2	
P_D^d	Maximum Power Dissipation	$T_C=25^\circ\text{C}$	29	
		$T_C=100^\circ\text{C}$	12	
$R_{\theta JA}^{a,c}$	Thermal Resistance-Junction to Ambient	$t \leq 10\text{s}$	40	
		Steady State	75	
$R_{\theta JC}^d$	Thermal Resistance-Junction to Case	Steady State	4.2	$^\circ\text{C/W}$

Note a : Surface Mounted on 1in^2 pad area, $t \leq 10\text{sec}$.

Note b : UIS tested and pulse width limited by maximum junction temperature 150°C (initial temperature $T_J=25^\circ\text{C}$).

Note c : Maximum under Steady State conditions is 75°C/W .

Note d : The power dissipation P_D is based on $T_{J(\text{MAX})} = 150^\circ\text{C}$, and it is useful for reducing junction-to-case thermal resistance ($R_{\theta JC}$) when additional heat sink is used.

Electrical Characteristics $(T_A = 25^\circ\text{C}$ Unless Otherwise Noted)

Symbol	Parameter	Test Conditions	Min.	Typ.	Max.	Unit
Static Characteristics						
BV_{DSS}	Drain-Source Breakdown Voltage	$V_{GS}=0V, I_{DS}=-250\mu\text{A}$	-30	-	-	V
I_{DSS}	Zero Gate Voltage Drain Current	$V_{DS}=-24V, V_{GS}=0V$ $T_J=85^\circ\text{C}$	-	-	-1	μA
			-	-	-30	
$V_{GS(\text{th})}$	Gate Threshold Voltage	$V_{DS}=V_{GS}, I_{DS}=-250\mu\text{A}$	-1.5	-2	-2.5	V
I_{GSS}	Gate Leakage Current	$V_{GS}=\pm 25V, V_{DS}=0V$	-	-	± 100	nA
$R_{DS(\text{ON})}^e$	Drain-Source On-state Resistance	$V_{GS}=-10V, I_{DS}=-11A$	-	14	18	m Ω
		$V_{GS}=-4.5V, I_{DS}=-4A$	-	22	30	

Electrical Characteristics (Cont.) (T_A = 25°C Unless Otherwise Noted)

Symbol	Parameter	Test Conditions	Min.	Typ.	Max.	Unit
Diode Characteristics						
V _{SD} ^e	Diode Forward Voltage	I _{SD} =-1A, V _{GS} =0V	-	-0.7	-1	V
t _{rr} ^f	Reverse Recovery Time	I _{SD} =-11A, di _{SD} /dt=100A/μs	-	19	-	ns
Q _{rr} ^f	Reverse Recovery Charge		-	10	-	nC
Dynamic Characteristics^f						
R _g	Gate Resistance	V _{GS} =0V, V _{DS} =0V, F=1MHz	-	3	-	Ω
C _{iss}	Input Capacitance	V _{GS} =0V, V _{DS} =-15V, Frequency=1.0MHz	-	1000	-	pF
C _{oss}	Output Capacitance		-	210	-	
C _{rss}	Reverse Transfer Capacitance		-	150	-	
t _{d(ON)}	Turn-on Delay Time	V _{DD} =-15V, R _L =15Ω, I _{DS} =-1A, V _{GEN} =-10V, R _G =6Ω	-	8	-	ns
t _r	Turn-on Rise Time		-	12	-	
t _{d(OFF)}	Turn-off Delay Time		-	32	-	
t _f	Turn-off Fall Time		-	16	-	
Gate Charge Characteristics^f						
Q _g	Total Gate Charge	V _{DS} =-15V, V _{GS} =-10V, I _{DS} =-11A	-	21	-	nC
Q _{gs}	Gate-Source Charge		-	2.6	-	
Q _{gd}	Gate-Drain Charge		-	6.2	-	

Note e : Pulse test ; pulse width≤300μs, duty cycle≤2%.

Note f : Guaranteed by design, not subject to production testing.

Typical Operating Characteristics

Power Dissipation

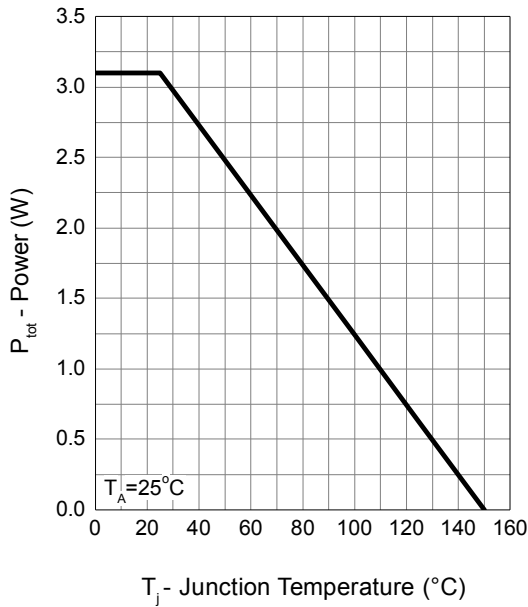

Drain Current

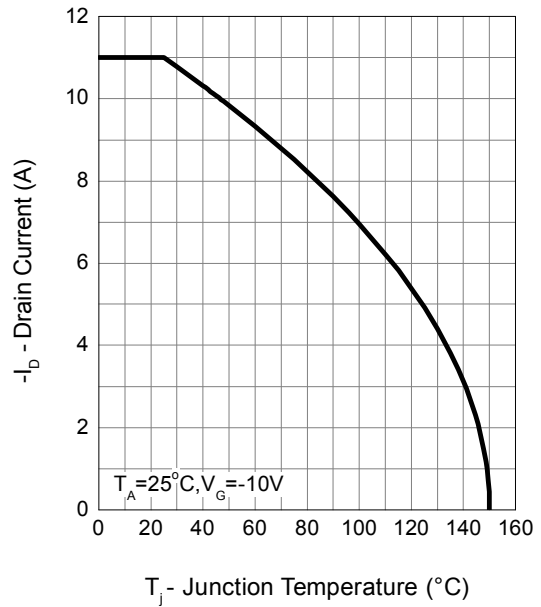

Safe Operation Area

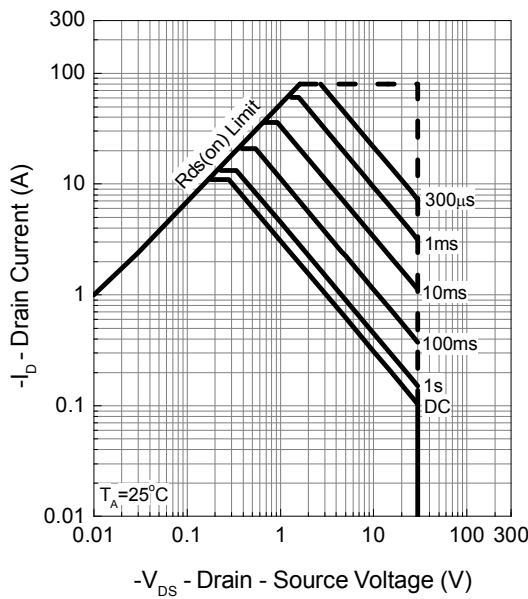

Thermal Transient Impedance

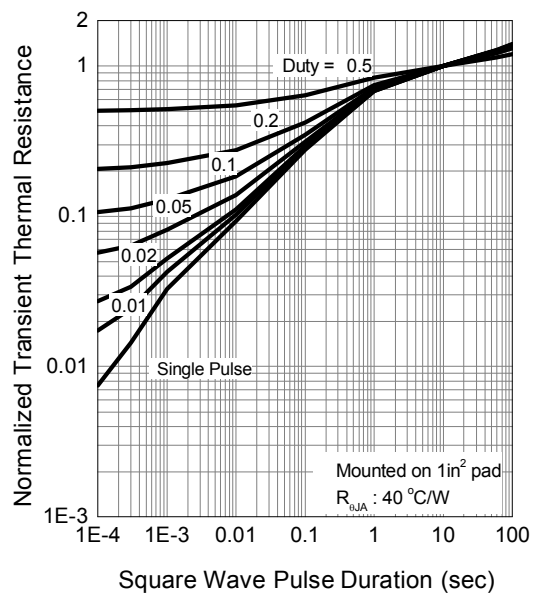

Typical Operating Characteristics (Cont.)

Output Characteristics

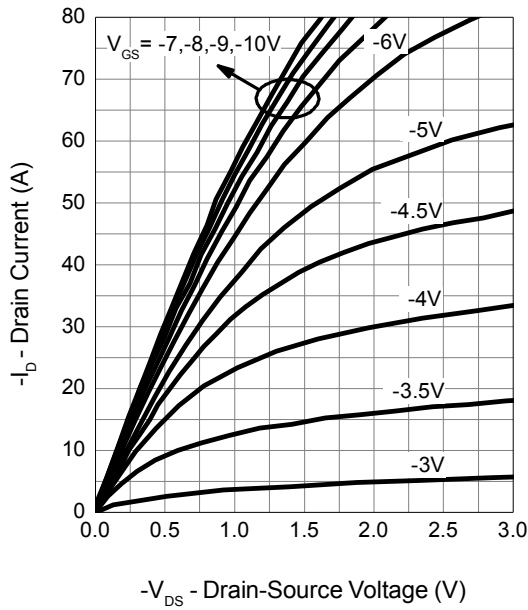

Drain-Source On Resistance

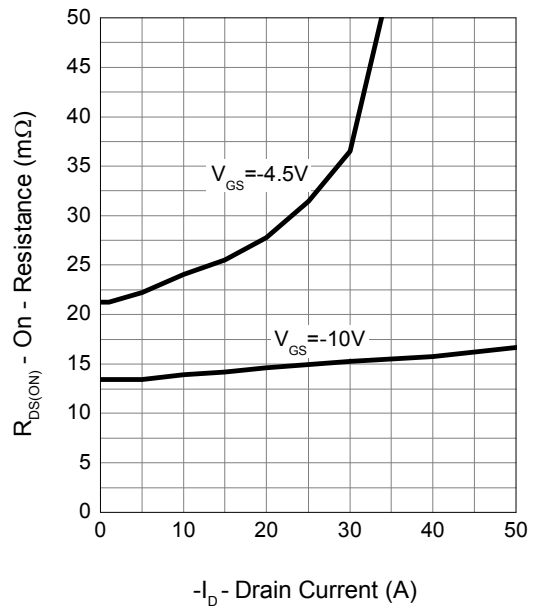

Gate-Source On Resistance

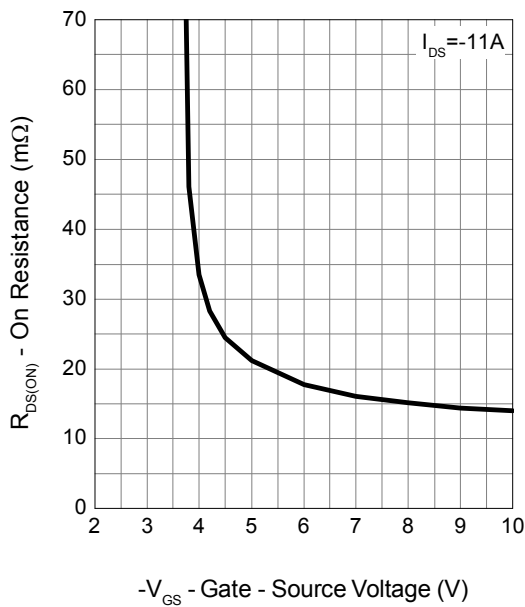

Gate Threshold Voltage

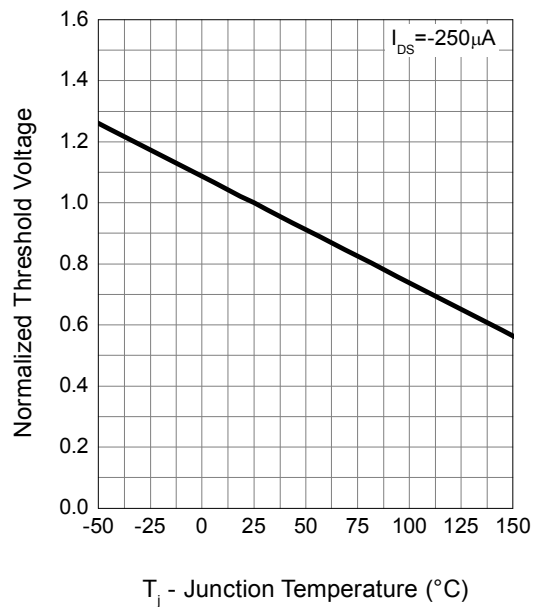

Typical Operating Characteristics (Cont.)

Drain-Source On Resistance

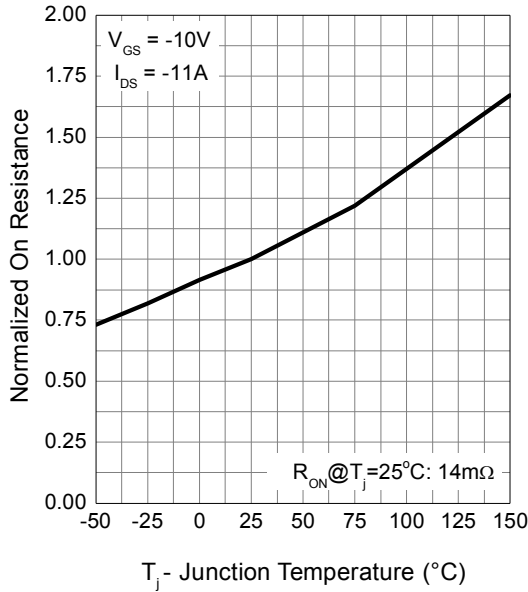

Source-Drain Diode Forward

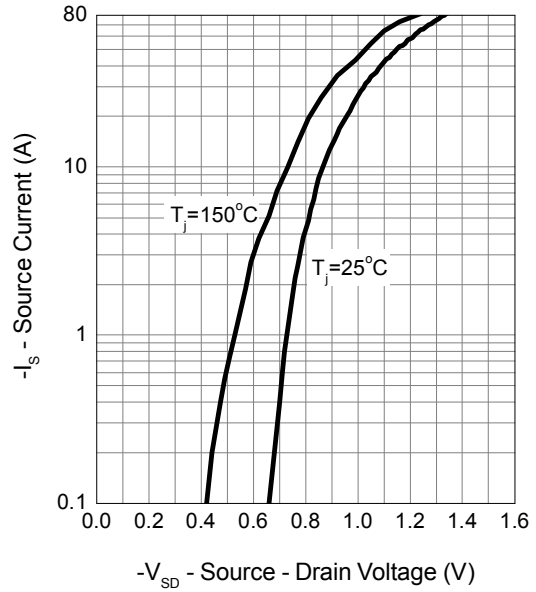

Capacitance

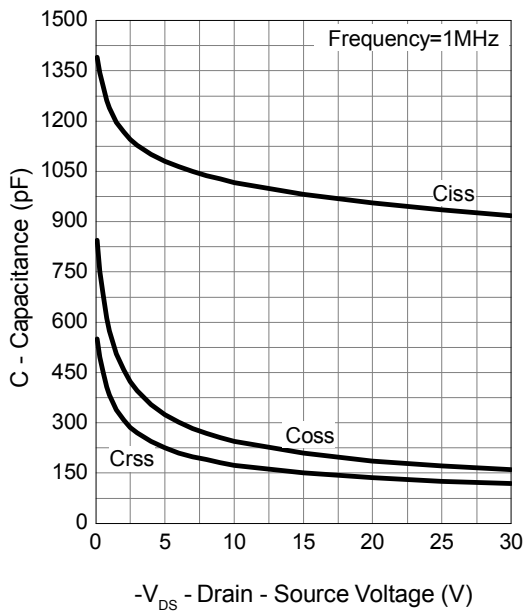

Gate Charge

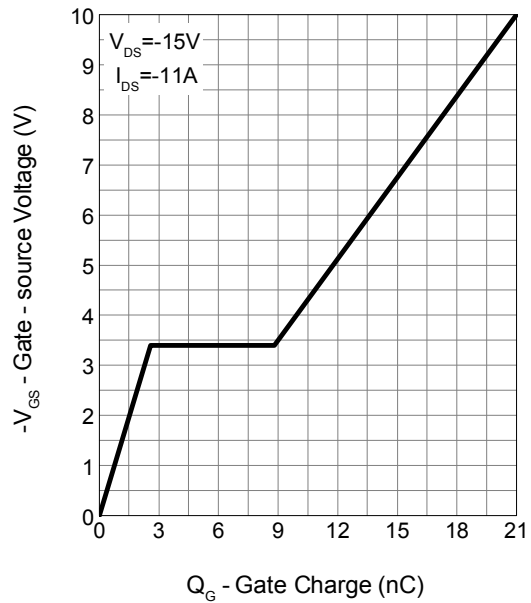

Avalanche Test Circuit and Waveforms

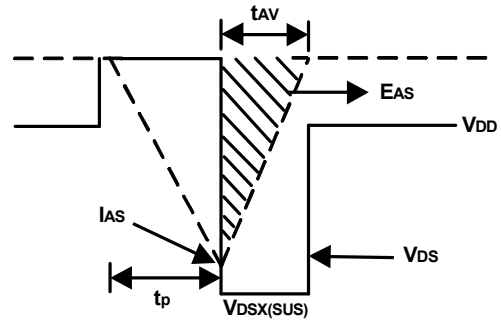
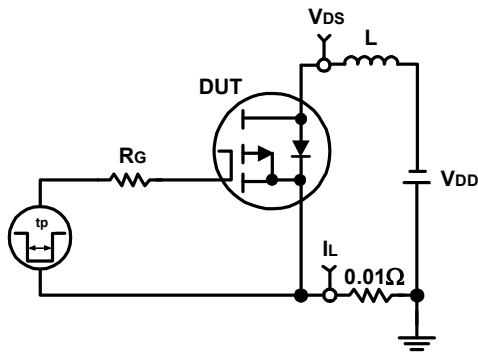

Switching Time Test Circuit and Waveforms

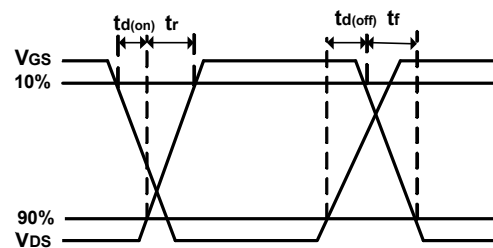
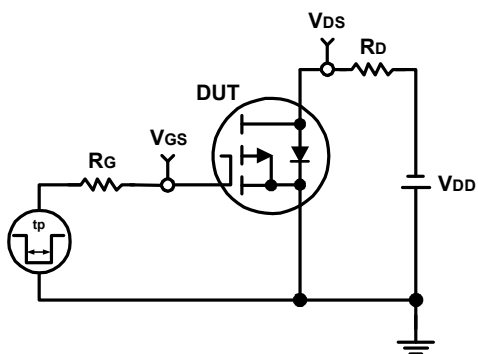

Package Information

DFN3x3-8(punch type)

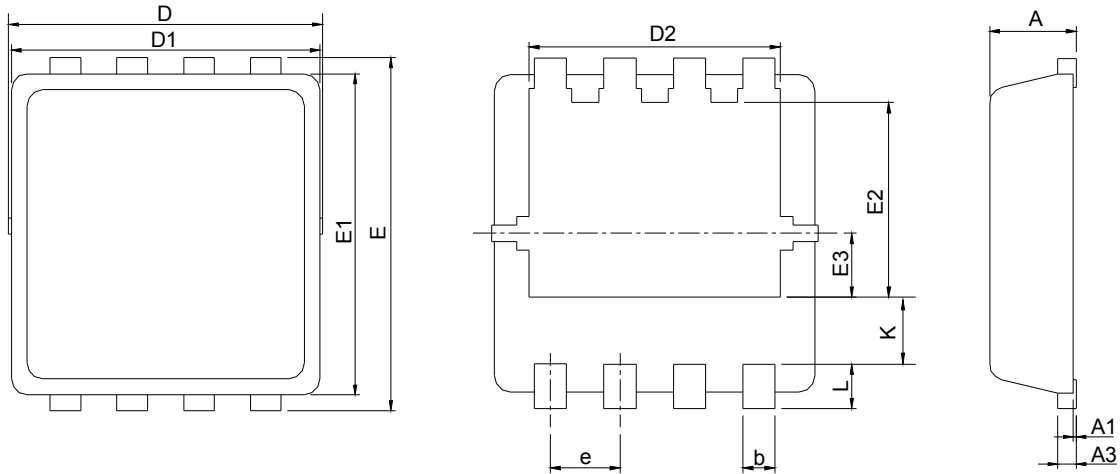

SYMBOL	DFN3x3-8			
	MILLIMETERS		INCHES	
	MIN.	MAX.	MIN.	MAX.
A	0.80	1.00	0.031	0.039
A1	0.00	0.05	0.000	0.002
A3	0.10	0.25	0.004	0.010
b	0.24	0.35	0.009	0.014
D	2.90	3.30	0.114	0.130
D1	2.90	3.10	0.114	0.122
D2	2.25	2.45	0.089	0.096
E	3.10	3.30	0.122	0.130
E1	2.90	3.10	0.114	0.122
E2	1.65	1.85	0.065	0.073
E3	0.56	0.58	0.022	0.023
e	0.65 BSC		0.026 BSC	
K	0.475	0.775	0.019	0.031
L	0.30	0.50	0.012	0.020

RECOMMENDED LAND PATTERN

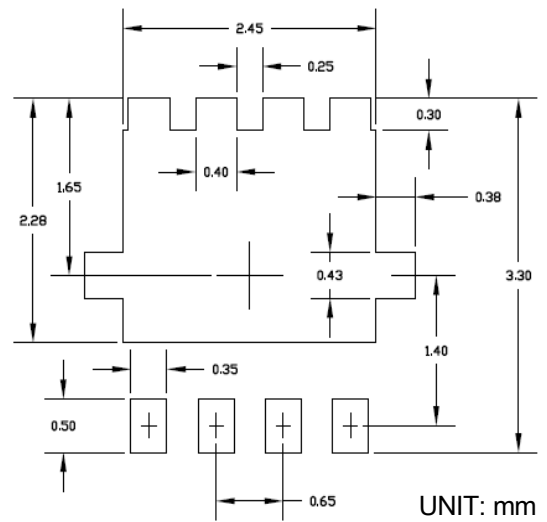

Package Information

DFN3x3-8(saw type)

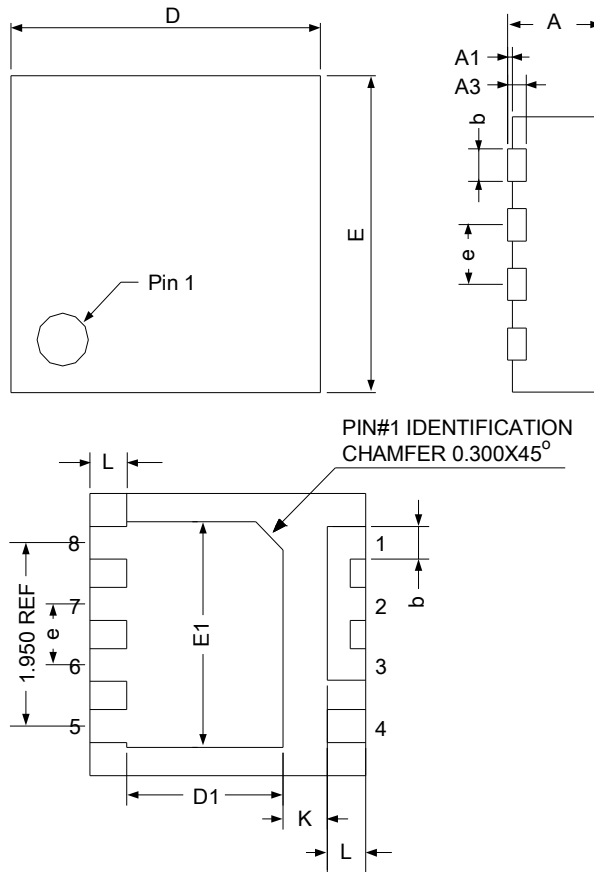

SYMBOL	DFN3x3-8			
	MILLIMETERS		INCHES	
	MIN.	MAX.	MIN.	MAX.
A	0.70	1.00	0.028	0.039
A1	0.00	0.05	0.000	0.002
A3	0.203 REF		0.008 REF	
b	0.25	0.40	0.010	0.016
D	2.90	3.10	0.114	0.122
E1	2.25	2.55	0.089	0.1
E	2.90	3.10	0.114	0.122
D1	1.65	1.9	0.065	0.075
e	0.65 BSC		0.026 BSC	
L	0.30	0.50	0.012	0.020
K	0.43	-	0.017	-

RECOMMENDED LAND PATTERN

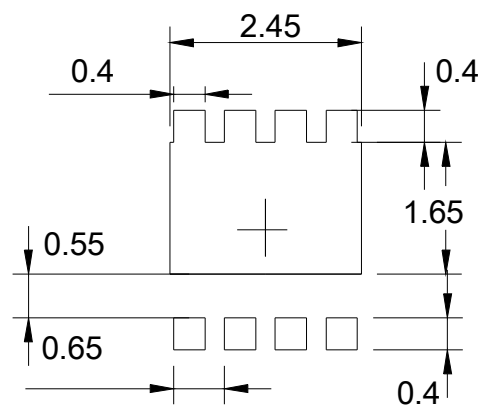

UNIT: mm

Carrier Tape & Reel Dimensions

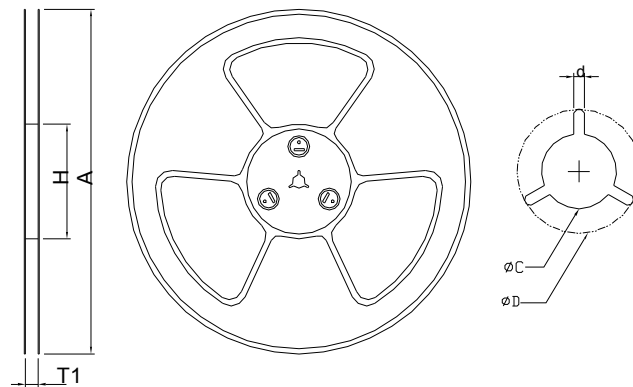
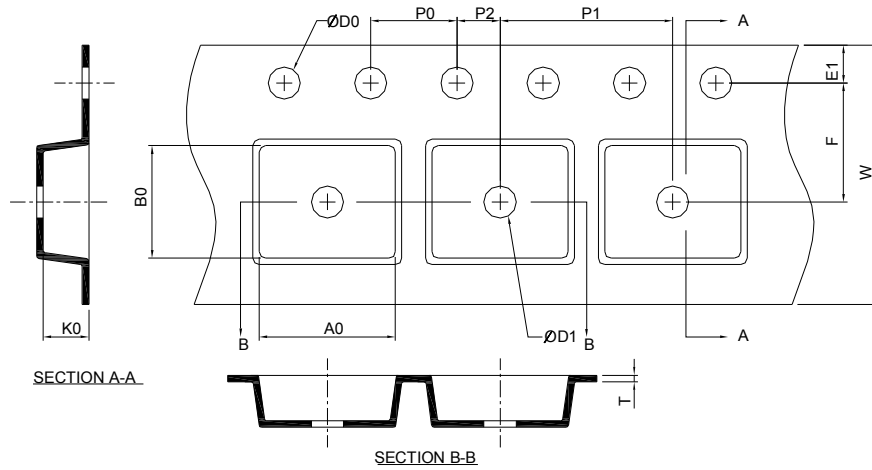

Application	A	H	T1	C	d	D	W	E1	F
DFN3x3-8 (punch type)	178.0±2.00	50 MIN.	8.4+2.00 -0.00	13.0+0.50 -0.20	1.5 MIN.	20.2 MIN.	8.0±0.20	1.75±0.10	3.5±0.05
	P0	P1	P2	D0	D1	T	A0	B0	K0
	4.0±0.10	8.0±0.10	2.0±0.05	1.5+0.10 -0.00	1.5 MIN.	0.6+0.00 -0.40	3.35±0.20	3.35±0.20	1.30±0.20

(mm)

Application	A	H	T1	C	d	D	W	E1	F
DFN3x3-8 (saw type)	330.0±2.00	177 MIN.	12.4+2.00 -0.00	13.0+0.50 -0.20	1.5 MIN.	21.0±0.50	12.0+0.30 -0.10	1.75±0.10	5.5±0.05
	P0	P1	P2	D0	D1	T	A0	B0	K0
	4.0±0.10	8.0±0.10	2.0±0.05	1.5+0.10 -0.00	1.5 MIN.	0.23±0.05	3.23±0.10	3.23±0.10	1.05±0.10

(mm)

Taping Direction Information

DFN3x3-8(punch type)

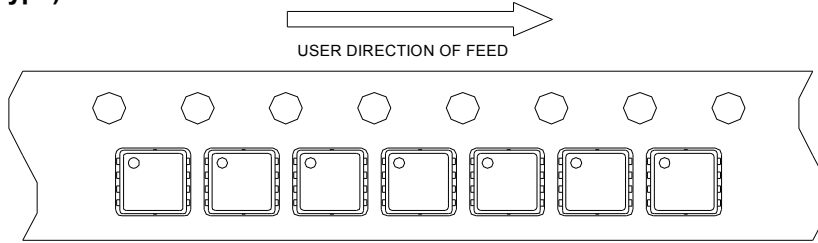

DFN3x3-8(saw type)

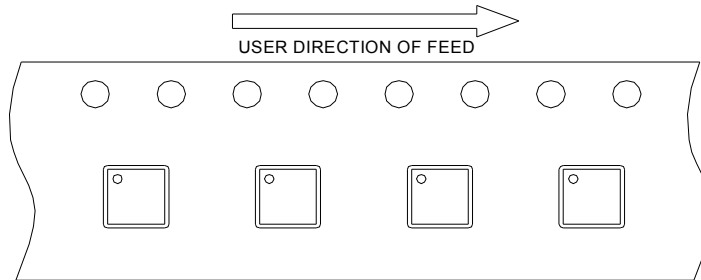

Classification Profile

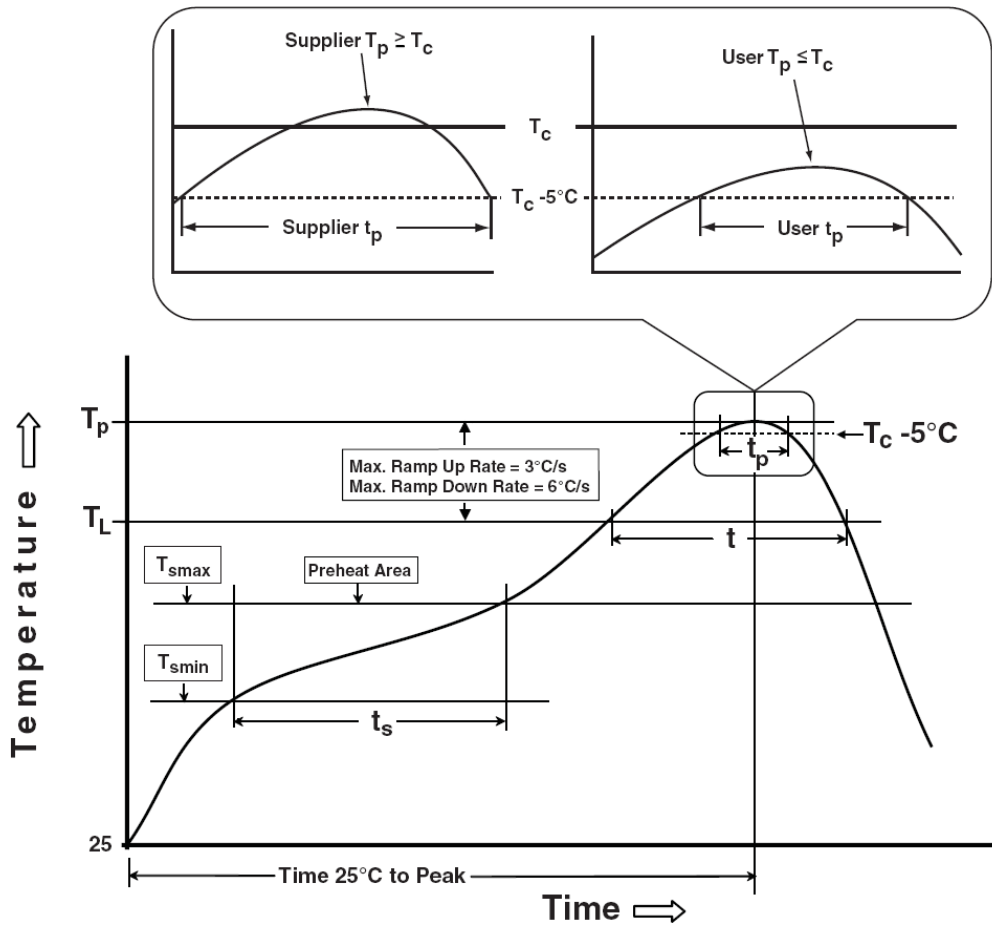

Classification Reflow Profiles

Profile Feature	Sn-Pb Eutectic Assembly	Pb-Free Assembly
Preheat & Soak		
Temperature min (T_{smin})	100 °C	150 °C
Temperature max (T_{smax})	150 °C	200 °C
Time (T_{smin} to T_{smax}) (t_s)	60-120 seconds	60-120 seconds
Average ramp-up rate (T_{smax} to T_p)	3 °C/second max.	3°C/second max.
Liquidous temperature (T_L)	183 °C	217 °C
Time at liquidous (t_L)	60-150 seconds	60-150 seconds
Peak package body Temperature (T_p)*	See Classification Temp in table 1	See Classification Temp in table 2
Time (t_p)** within 5°C of the specified classification temperature (T_c)	20** seconds	30** seconds
Average ramp-down rate (T_p to T_{smax})	6 °C/second max.	6 °C/second max.
Time 25°C to peak temperature	6 minutes max.	8 minutes max.
* Tolerance for peak profile Temperature (T_p) is defined as a supplier minimum and a user maximum. ** Tolerance for time at peak profile temperature (t_p) is defined as a supplier minimum and a user maximum.		

Table 1. SnPb Eutectic Process – Classification Temperatures (T_c)

Package Thickness	Volume mm ³ <350	Volume mm ³ ≥350
<2.5 mm	235 °C	220 °C
≥2.5 mm	220 °C	220 °C

Table 2. Pb-free Process – Classification Temperatures (T_c)

Package Thickness	Volume mm ³ <350	Volume mm ³ 350-2000	Volume mm ³ >2000
<1.6 mm	260 °C	260 °C	260 °C
1.6 mm – 2.5 mm	260 °C	250 °C	245 °C
≥2.5 mm	250 °C	245 °C	245 °C

Reliability Test Program

Test item	Method	Description
SOLDERABILITY	JESD-22, B102	5 Sec, 245°C
HTRB	JESD-22, A108	1000 Hrs, 80% of VDS max @ T_{jmax}
HTGB	JESD-22, A108	1000 Hrs, 100% of VGS max @ T_{jmax}
PCT	JESD-22, A102	168 Hrs, 100%RH, 2atm, 121°C
TCT	JESD-22, A104	500 Cycles, -65°C~150°C

Customer Service

Sinopower Semiconductor, Inc.

5F, No. 6, Dusing 1St Rd., Hsinchu Science Park,

Hsinchu, 30078, Taiwan

TEL: 886-3-5635818 Fax: 886-3-5642050