

P-Channel Enhancement Mode MOSFET

Features

- 20V/-95A,
 $R_{DS(ON)} = 4.6m\Omega(max.) @ V_{GS} = -4.5V$
 $R_{DS(ON)} = 7m\Omega(max.) @ V_{GS} = -2.5V$
 $R_{DS(ON)} = 10m\Omega(max.) @ V_{GS} = -1.8V$
- Reliable and Rugged
- Lead Free and Green Devices Available (RoHS Compliant)
- HBM ESD protection level of 2.3KV typical

Note : The diode connected between the gate and source serves only as protection against ESD. No gate overvoltage rating is implied.

Applications

- Power Management in Notebook Computer, Portable Equipment and Battery Powered Systems.

Pin Description

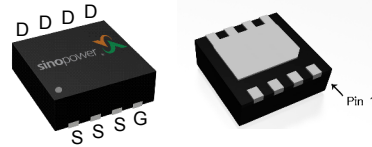

DFN3.3x3.3-8

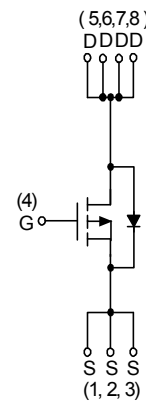

P-Channel MOSFET

Ordering and Marking Information

<p>SM3403PS □□□-□□□</p> <div style="margin-left: 20px;"> <p>□□□ — Assembly Material</p> <p>□□ — Handling Code</p> <p>□ — Temperature Range</p> <p>□ — Package Code</p> </div>	<p>Package Code QG : DFN3.3x3.3-8 Operating Junction Temperature Range C : -55 to 150 °C Handling Code TR : Tape & Reel (3000ea/reel) Assembly Material G : Halogen and Lead Free Device</p>
<p>SM3403PS QG :</p> <div style="border: 1px solid black; padding: 2px; display: inline-block; margin-left: 20px;"> SM 3403 XXXXX </div>	<p>XXXXX - Lot Code</p>

Note : SINOPOWER lead-free products contain molding compounds/die attach materials and 100% matte tin plate termination finish; which are fully compliant with RoHS. SINOPOWER lead-free products meet or exceed the lead-free requirements of IPC/JEDEC J-STD-020D for MSL classification at lead-free peak reflow temperature. SINOPOWER defines "Green" to mean lead-free (RoHS compliant) and halogen free (Br or Cl does not exceed 900ppm by weight in homogeneous material and total of Br and Cl does not exceed 1500ppm by weight).

SINOPOWER reserves the right to make changes to improve reliability or manufacturability without notice, and advise customers to obtain the latest version of relevant information to verify before placing orders.

Absolute Maximum Ratings ($T_A = 25^\circ\text{C}$ Unless Otherwise Noted)

Symbol	Parameter	Rating	Unit	
V_{DSS}	Drain-Source Voltage	-20	V	
V_{GSS}	Gate-Source Voltage	± 12		
I_D^a	Continuous Drain Current ($V_{GS}=-4.5V$)	$T_A=25^\circ\text{C}$	-25	A
		$T_A=70^\circ\text{C}$	-20	
I_{DM}^a	Pulsed Drain Current ($V_{GS}=-4.5V$)	-100 *		
I_D^c	Continuous Drain Current	$T_C=25^\circ\text{C}$	-95	
		$T_C=100^\circ\text{C}$	-60	
I_S^a	Diode Continuous Forward Current	-50		
T_J	Maximum Junction Temperature	150	$^\circ\text{C}$	
I_{AS}^d	Avalanche Current, Single pulse	$L=0.5\text{mH}$	-22	A
E_{AS}^d	Avalanche Energy, Single pulse	$L=0.5\text{mH}$	121	mJ
T_{STG}	Storage Temperature Range	-55 to 150	$^\circ\text{C}$	
P_D^a	Maximum Power Dissipation	$T_A=25^\circ\text{C}$	4.2	W
		$T_A=70^\circ\text{C}$	2.7	
P_D^c	Maximum Power Dissipation	$T_C=25^\circ\text{C}$	62.5	
		$T_C=100^\circ\text{C}$	25	
$R_{\theta JA}^{a,b}$	Thermal Resistance-Junction to Ambient	$t \leq 10\text{s}$	30	$^\circ\text{C/W}$
		Steady State	70	
$R_{\theta JC}^c$	Thermal Resistance-Junction to Case	2	$^\circ\text{C/W}$	

Note * : Package limited.

Note a : Surface Mounted on 1in^2 pad area, $t \leq 10\text{sec}$.

Note b : Maximum under Steady State conditions is 75°C/W .

Note c : The power dissipation P_D is based on $T_{J(\text{MAX})} = 150^\circ\text{C}$, and it is useful for reducing junction-to-case thermal resistance ($R_{\theta JC}$) when additional heat sink is used.

Note d : UIS tested and pulse width limited by maximum junction temperature 150°C (initial temperature $T_J=25^\circ\text{C}$).

Electrical Characteristics (T_A = 25°C Unless Otherwise Noted)

Symbol	Parameter	Test Conditions	Min.	Typ.	Max.	Unit
Static Characteristics						
BV _{DSS}	Drain-Source Breakdown Voltage	V _{GS} =0V, I _{DS} =-250μA	-20	-	-	V
I _{DSS}	Zero Gate Voltage Drain Current	V _{DS} =-16V, V _{GS} =0V	-	-	-1	μA
		T _J =85°C	-	-	-30	
V _{GS(th)}	Gate Threshold Voltage	V _{DS} =V _{GS} , I _{DS} =-250μA	-0.4	-	-0.9	V
I _{GSS}	Gate Leakage Current	V _{GS} =±12V, V _{DS} =0V	-	-	±100	nA
R _{DS(ON)} ^e	Drain-Source On-state Resistance	V _{GS} =-4.5V, I _{DS} =-20A	-	3.6	4.6	mΩ
		V _{GS} =-2.5V, I _{DS} =-20A	-	4.9	7	
		V _{GS} =-1.8V, I _{DS} =-10A	-	7	10	
Diode Characteristics						
V _{SD} ^e	Diode Forward Voltage	I _{SD} =-1A, V _{GS} =0V	-	-0.5	-1	V
t _{rr} ^f	Reverse Recovery Time	I _{SD} =-20A, di _{SD} /dt=100A/μs	-	33	-	ns
Q _{rr} ^f	Reverse Recovery Charge		-	17	-	nC
Dynamic Characteristics^f						
C _{iss}	Input Capacitance	V _{GS} =0V, V _{DS} =-10V, Frequency=1.0MHz	-	5360	-	pF
C _{oss}	Output Capacitance		-	1030	-	
C _{riss}	Reverse Transfer Capacitance		-	820	-	
R _g	Gate Resistance	V _{GS} =0V, V _{DS} =0V, F=1MHz	-	3	-	Ω
t _{d(ON)}	Turn-on Delay Time	V _{DD} =-10V, R _L =10Ω, I _{DS} =-1A, V _{GEN} =-4.5V, R _G =6Ω	-	19	-	ns
t _r	Turn-on Rise Time		-	25	-	
t _{d(OFF)}	Turn-off Delay Time		-	228	-	
t _f	Turn-off Fall Time		-	72	-	
Gate Charge Characteristics^f						
Q _g	Total Gate Charge	V _{DS} =-10V, V _{GS} =-4.5V, I _{DS} =-20A	-	54	-	nC
Q _{gs}	Gate-Source Charge		-	4.1	-	
Q _{gd}	Gate-Drain Charge		-	17	-	

Note e : Pulse test; pulse width≤300μs, duty cycle≤2%.

Note f : Guaranteed by design, not subject to production testing.

Typical Operating Characteristics

Power Dissipation

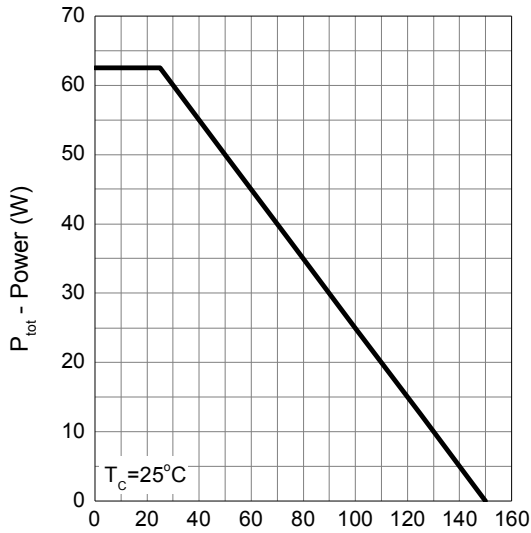

T_j - Junction Temperature (°C)

Drain Current

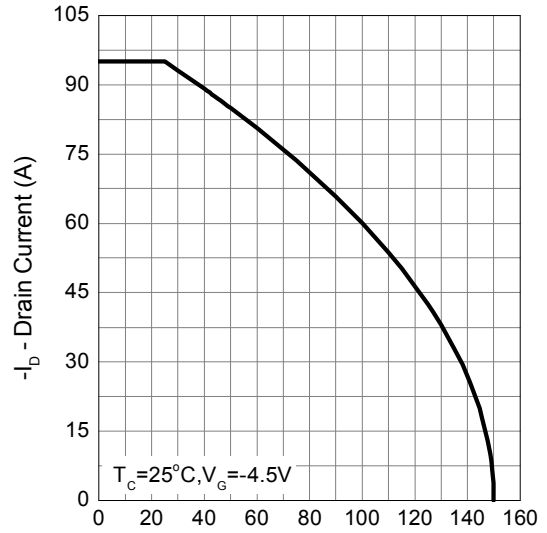

T_j - Junction Temperature (°C)

Safe Operation Area

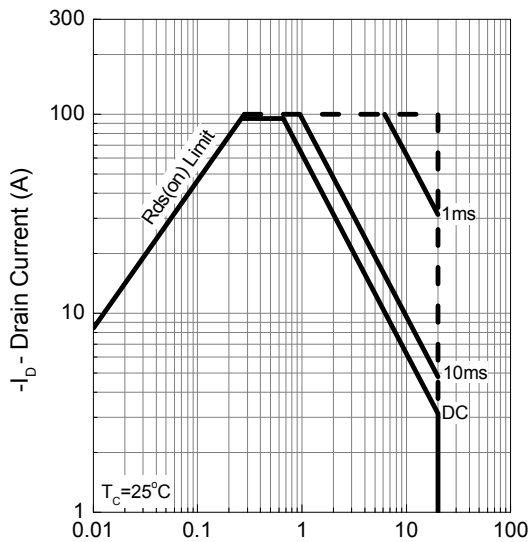

$-V_{DS}$ - Drain - Source Voltage (V)

Thermal Transient Impedance

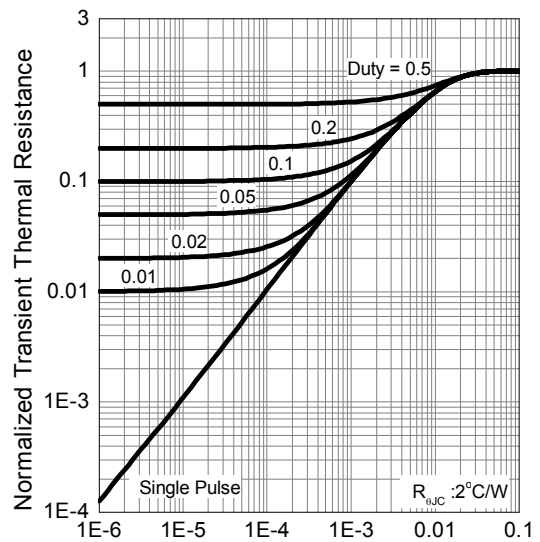

Square Wave Pulse Duration (sec)

Typical Operating Characteristics (Cont.)

Output Characteristics

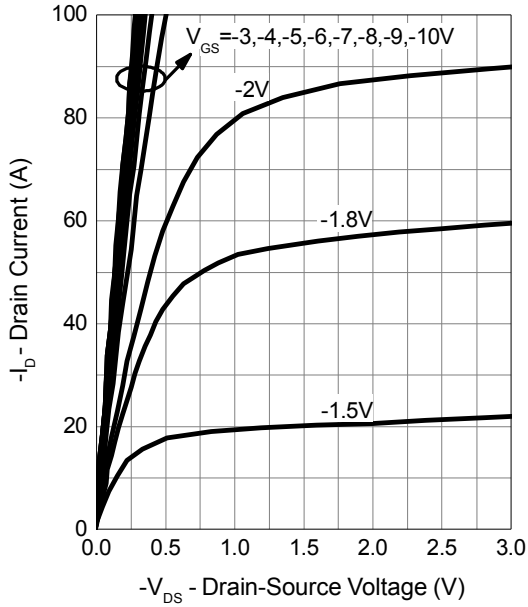

Drain-Source On Resistance

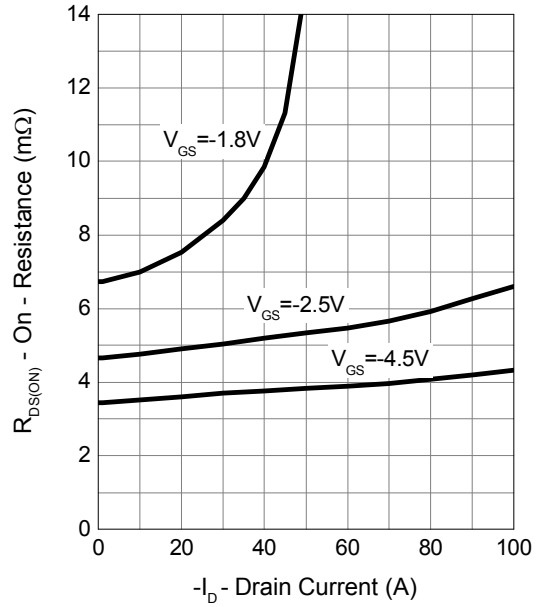

Gate-Source On Resistance

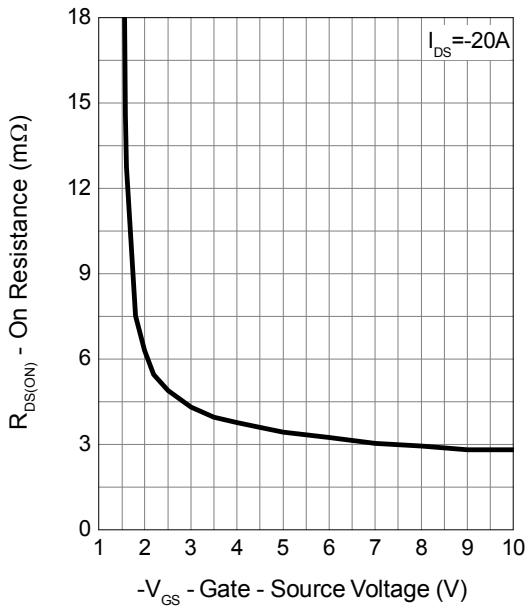

Gate Threshold Voltage

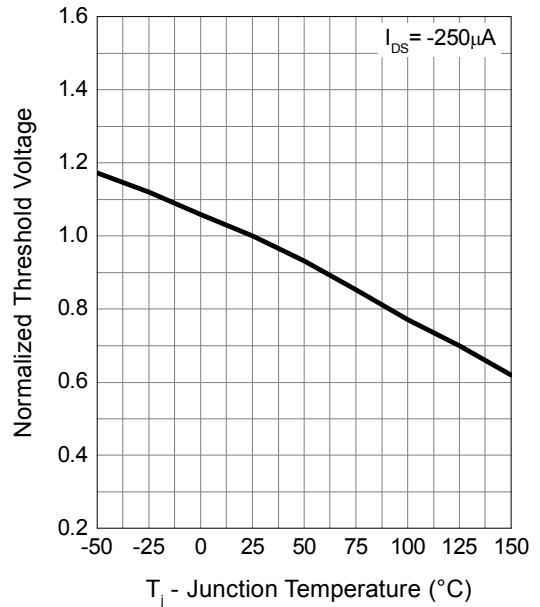

Typical Operating Characteristics (Cont.)

Drain-Source On Resistance

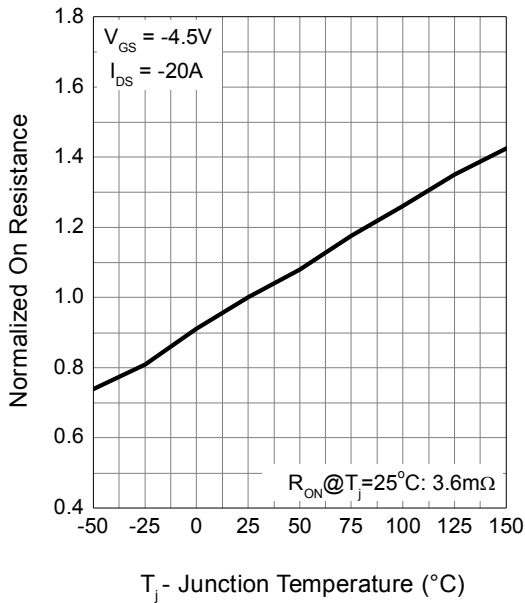

Source-Drain Diode Forward

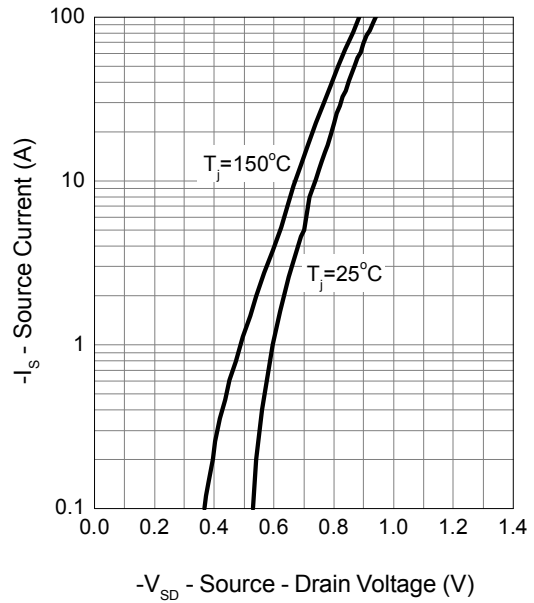

Capacitance

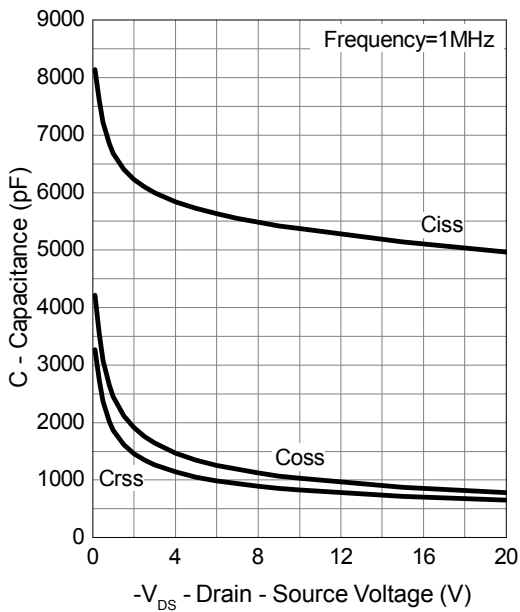

Gate Charge

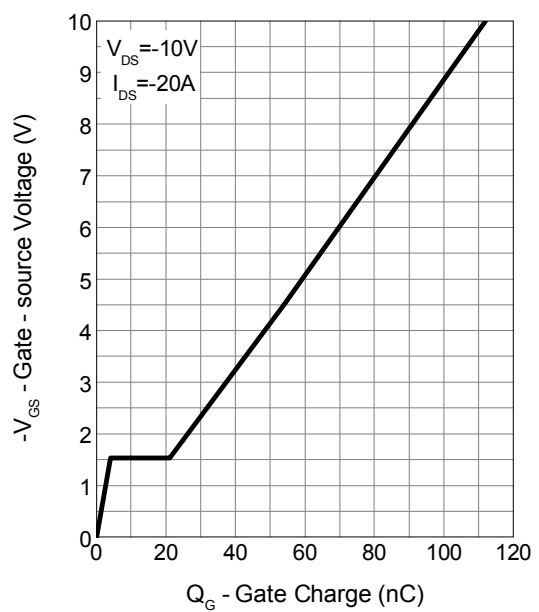

Avalanche Test Circuit and Waveforms

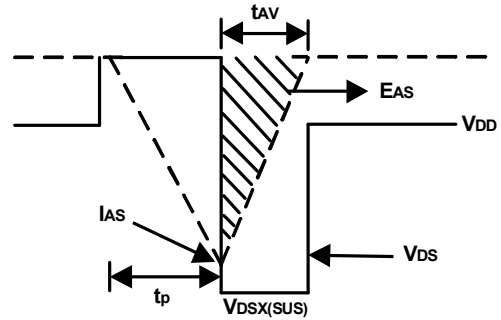
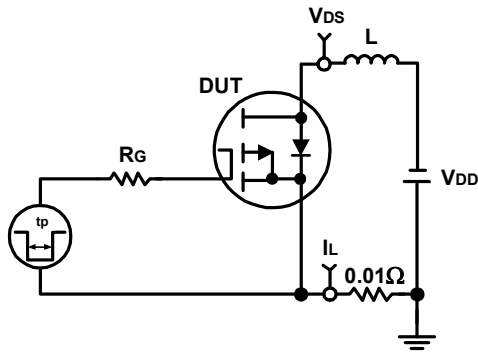

Switching Time Test Circuit and Waveforms

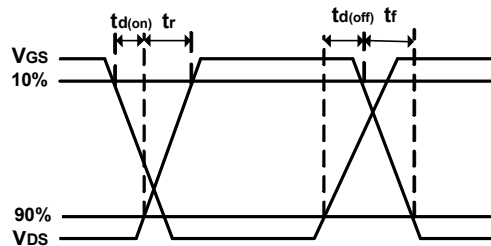
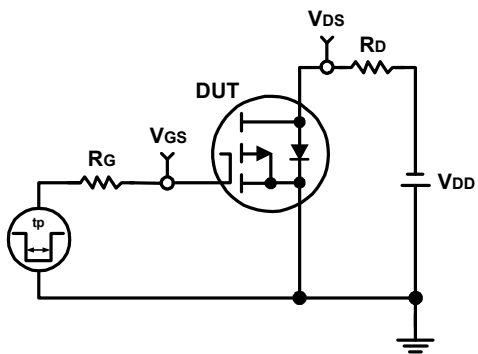

Package Information

DFN3.3x3.3-8

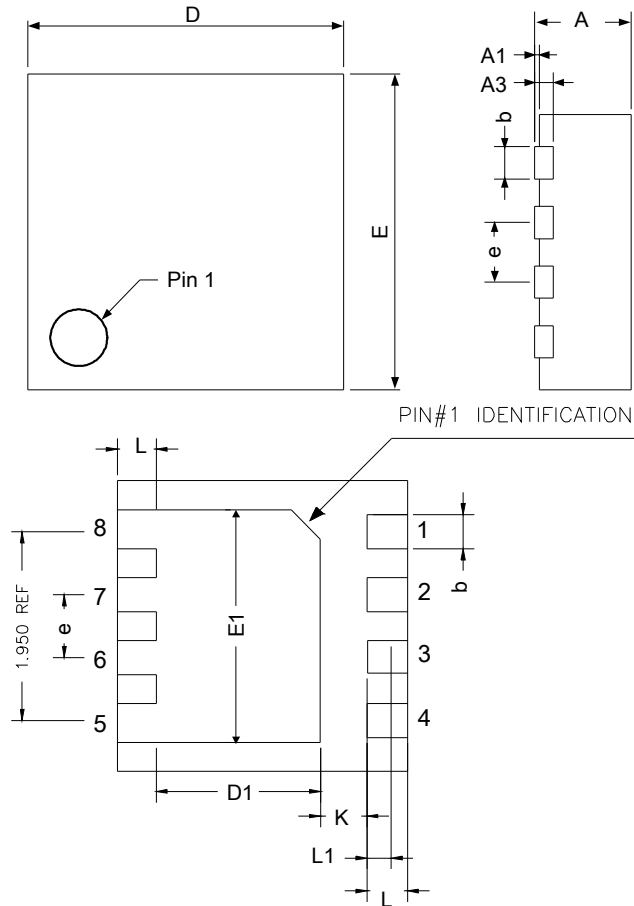

SYMBOL	DFN3.3x3.3-8			
	MILLIMETERS		INCHES	
	MIN.	MAX.	MIN.	MAX.
A	0.70	1.00	0.028	0.039
A1	0.00	0.05	0.000	0.002
A3	0.10	0.25	0.004	0.010
b	0.25	0.35	0.010	0.014
D	3.15	3.40	0.124	0.134
E1	2.05	2.45	0.081	0.096
E	3.15	3.40	0.124	0.134
D1	1.65	1.90	0.065	0.075
e	0.65 BSC		0.026 BSC	
L	0.30	0.50	0.012	0.020
K	0.45	-	0.018	-

RECOMMENDED LAND PATTERN

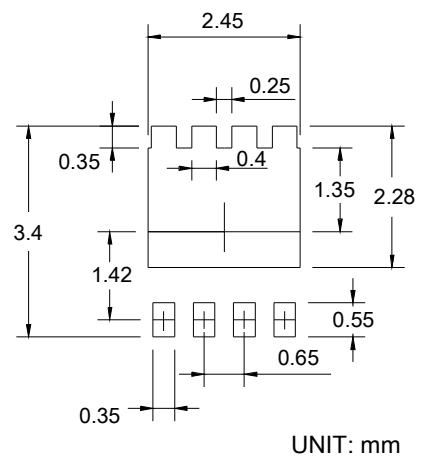

Carrier Tape & Reel Dimensions

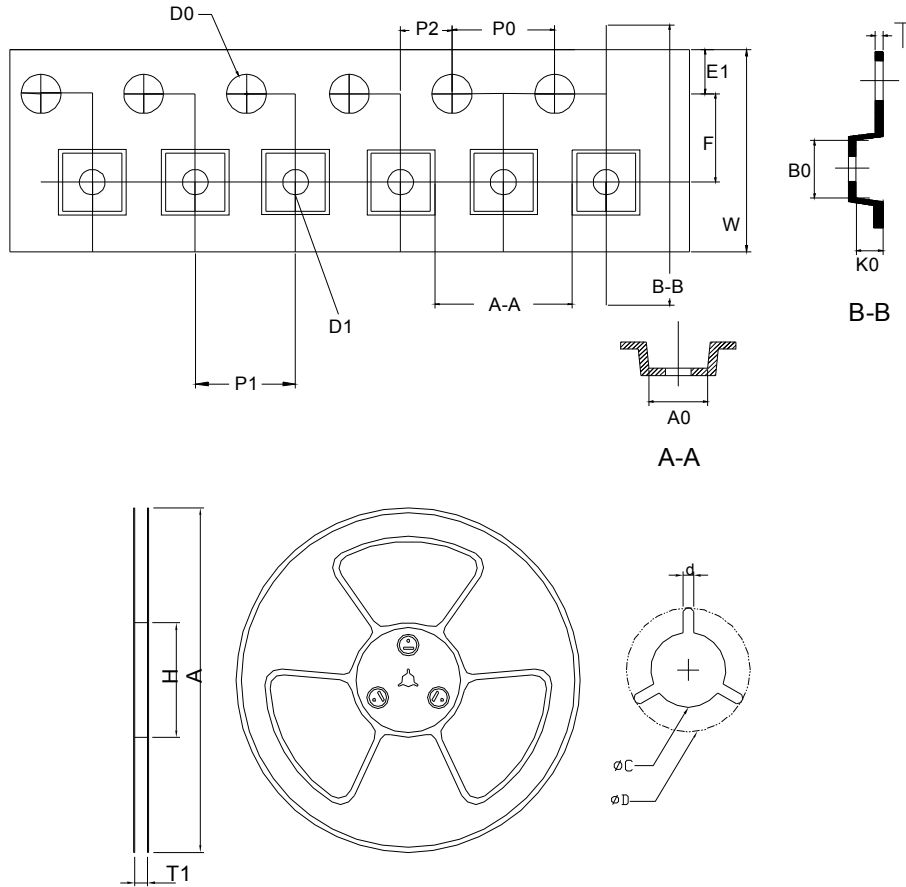

Application	A	H	T1	C	d	D	W	E1	F
DFN3.3x3.3-8 (punch type)	330.0±2.00	50 MIN.	13.0±0.3	13.0+0.50 -0.20	1.5 MIN.	20.2 MIN.	12.0±0.30	1.75±0.10	5.5±0.05
	P0	P1	P2	D0	D1	T	A0	B0	K0
	4.0±0.10	8.0±0.10	2.0±0.05	1.5+0.10 -0.00	1.5 MIN.	0.6+0.00 -0.4	3.6±0.20	3.6±0.20	1.05±0.20

(mm)

Taping Direction Information

DFN3.3x3.3-8

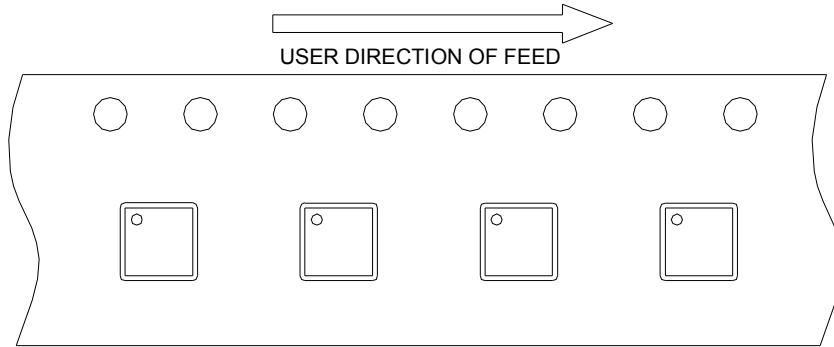

Classification Profile

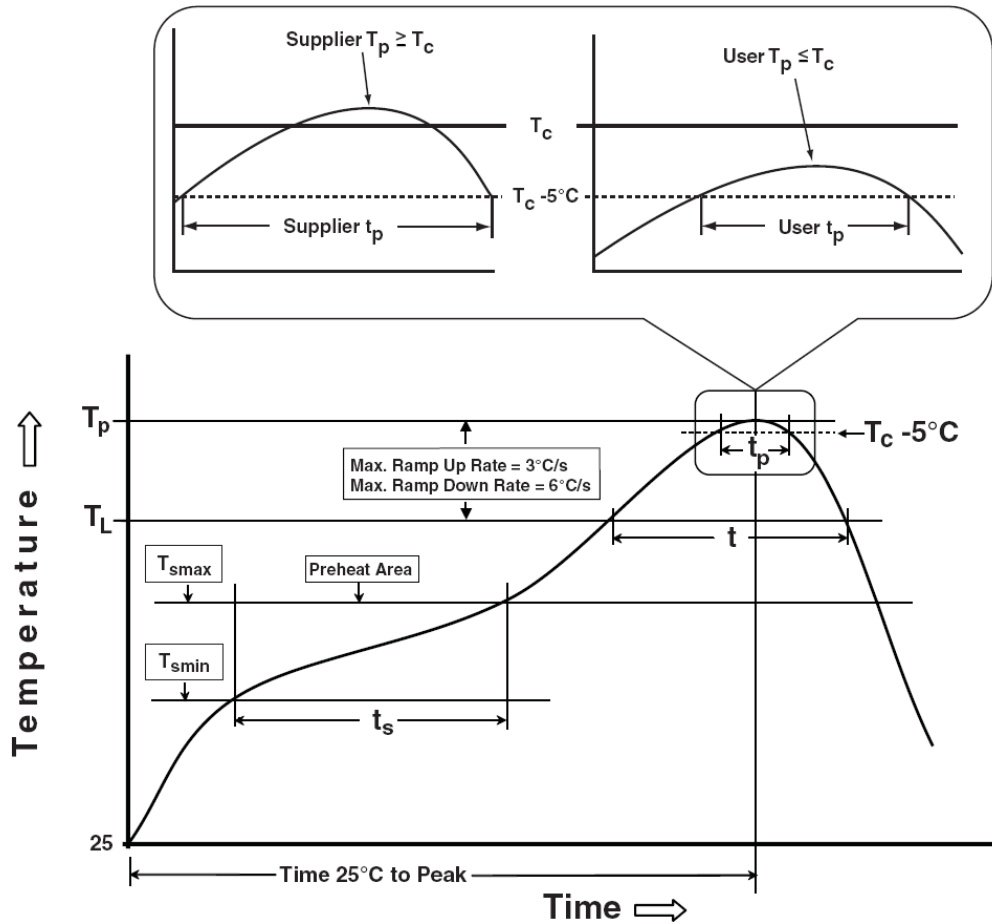

Classification Reflow Profiles

Profile Feature	Sn-Pb Eutectic Assembly	Pb-Free Assembly
Preheat & Soak		
Temperature min (T_{smin})	100 °C	150 °C
Temperature max (T_{smax})	150 °C	200 °C
Time (T_{smin} to T_{smax}) (t_s)	60-120 seconds	60-120 seconds
Average ramp-up rate (T_{smax} to T_p)	3 °C/second max.	3°C/second max.
Liquidous temperature (T_L)	183 °C	217 °C
Time at liquidous (t_L)	60-150 seconds	60-150 seconds
Peak package body Temperature (T_p)*	See Classification Temp in table 1	See Classification Temp in table 2
Time (t_p)** within 5°C of the specified classification temperature (T_c)	20** seconds	30** seconds
Average ramp-down rate (T_p to T_{smax})	6 °C/second max.	6 °C/second max.
Time 25°C to peak temperature	6 minutes max.	8 minutes max.
* Tolerance for peak profile Temperature (T_p) is defined as a supplier minimum and a user maximum. ** Tolerance for time at peak profile temperature (t_p) is defined as a supplier minimum and a user maximum.		

Table 1. SnPb Eutectic Process – Classification Temperatures (T_c)

Package Thickness	Volume mm ³ <350	Volume mm ³ ≥350
<2.5 mm	235 °C	220 °C
≥2.5 mm	220 °C	220 °C

Table 2. Pb-free Process – Classification Temperatures (T_c)

Package Thickness	Volume mm ³ <350	Volume mm ³ 350-2000	Volume mm ³ >2000
<1.6 mm	260 °C	260 °C	260 °C
1.6 mm – 2.5 mm	260 °C	250 °C	245 °C
≥2.5 mm	250 °C	245 °C	245 °C

Reliability Test Program

Test item	Method	Description
SOLDERABILITY	JESD-22, B102	5 Sec, 245°C
HTRB	JESD-22, A108	1000 Hrs, 80% of VDS max @ T_{jmax}
HTGB	JESD-22, A108	1000 Hrs, 100% of VGS max @ T_{jmax}
PCT	JESD-22, A102	168 Hrs, 100%RH, 2atm, 121°C
TCT	JESD-22, A104	500 Cycles, -65°C~150°C

Customer Service

Sinopower Semiconductor, Inc.

5F, No. 6, Dusing 1St Rd., Hsinchu Science Park,

Hsinchu, 30078, Taiwan

TEL: 886-3-5635818 Fax: 886-3-5642050