

## N-Channel Enhancement Mode MOSFET

### Features

- 30V/100A,  
 $R_{DS(ON)}=1.1m\Omega$  (Max.) @  $V_{GS}=10V$   
 $R_{DS(ON)}=1.7m\Omega$  (Max.) @  $V_{GS}=4.5V$
- 100% UIS +  $R_g$  Tested
- Reliable and Rugged
- Lower  $Q_g$  and  $Q_{gd}$  for high-speed switching
- Lower  $R_{DS(ON)}$  to Minimize Conduction Losses
- Lead Free and Green Devices Available (RoHS Compliant)

### Pin Description

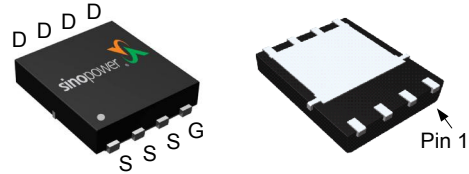

DFN5x6A-8\_EP

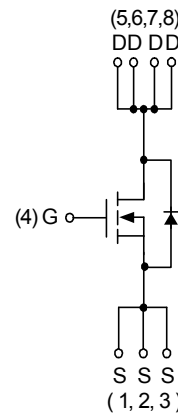

N-Channel MOSFET

### Applications

- OR-ing.
- Synchronous Rectifier for Server.
- Battery Charger and Power Circuits.

### Ordering and Marking Information

<p>SM4500NH <span style="font-family: monospace;">□□□-□□□</span></p> <div style="margin-left: 20px;"> <p>└─ Assembly Material</p> <p>└─ Handling Code</p> <p>└─ Temperature Range</p> <p>└─ Package Code</p> </div>	<p>Package Code                  KP : DFN5x6A-8_EP</p> <p>Operating Junction Temperature Range                  C : -55 to 150 °C</p> <p>Handling Code                  TR : Tape &amp; Reel</p> <p>Assembly Material                  G : Halogen and Lead Free Device</p>
<p>SM4500NH KP : <span style="border: 1px solid black; padding: 2px; display: inline-block; text-align: center;">                      4500NH                      XXXXX                 </span></p>	<p>XXXXX - Lot Code</p>

Note : SINOPOWER lead-free products contain molding compounds/die attach materials and 100% matte tin plate termination finish; which are fully compliant with RoHS. SINOPOWER lead-free products meet or exceed the lead-free requirements of IPC/JEDEC J-STD-020D for MSL classification at lead-free peak reflow temperature. SINOPOWER defines "Green" to mean lead-free (RoHS compliant) and halogen free (Br or Cl does not exceed 900ppm by weight in homogeneous material and total of Br and Cl does not exceed 1500ppm by weight).

SINOPOWER reserves the right to make changes to improve reliability or manufacturability without notice, and advise customers to obtain the latest version of relevant information to verify before placing orders.

## Absolute Maximum Ratings (T<sub>A</sub> = 25°C Unless Otherwise Noted)

Symbol	Parameter	Rating	Unit	
<b>Common Ratings</b>				
V <sub>DSS</sub>	Drain-Source Voltage	30	V	
V <sub>GSS</sub>	Gate-Source Voltage	±20		
T <sub>J</sub>	Maximum Junction Temperature	150	°C	
T <sub>STG</sub>	Storage Temperature Range	-55 to 150		
I <sub>S</sub>	Diode Continuous Forward Current	T <sub>C</sub> =25°C	78	A
I <sub>D</sub> <sup>a</sup>	Continuous Drain Current	T <sub>C</sub> =25°C	100*	
		T <sub>C</sub> =100°C	100*	
I <sub>DM</sub> <sup>b</sup>	Pulsed Drain Current	T <sub>C</sub> =25°C	400	
P <sub>D</sub>	Maximum Power Dissipation	T <sub>C</sub> =25°C	86.8	W
		T <sub>C</sub> =100°C	34.7	
R <sub>θJC</sub>	Thermal Resistance-Junction to Case	Steady State	1.44	°C/W
I <sub>D</sub> <sup>c</sup>	Continuous Drain Current	T <sub>A</sub> =25°C	34	A
		T <sub>A</sub> =70°C	27	
P <sub>D</sub> <sup>c</sup>	Maximum Power Dissipation	T <sub>A</sub> =25°C	1.9	W
		T <sub>A</sub> =70°C	1.2	
R <sub>θJA</sub> <sup>c</sup>	Thermal Resistance-Junction to Ambient	t ≤ 10s	24	°C/W
		Steady State	65	
I <sub>AS</sub> <sup>d</sup>	Avalanche Current, Single pulse	L=0.1mH	68	A
E <sub>AS</sub> <sup>d</sup>	Avalanche Energy, Single pulse	L=0.1mH	231	mJ

Note a,\* : Max. continue current is limited by bonding wire.

Note b : Pulse width is limited by max. junction temperature.

Note c : R<sub>θJA</sub> steady state t=999s.

Note d : UIS tested and pulse width limited by maximum junction temperature 150°C (initial temperature T<sub>J</sub>=25°C).

## Electrical Characteristics (T<sub>A</sub> = 25°C unless otherwise noted)

Symbol	Parameter	Test Conditions	Min.	Typ.	Max.	Unit
<b>Static Characteristics</b>						
BV <sub>DSS</sub>	Drain-Source Breakdown Voltage	V <sub>GS</sub> =0V, I <sub>DS</sub> =250μA	30	-	-	V
BV <sub>DSS</sub> t	Drain-Source Breakdown Voltage (transient)	V <sub>GS</sub> =0V, I <sub>D(aval)</sub> =68A T <sub>case</sub> =25°C, t <sub>transient</sub> =100ns	34	-	-	V
I <sub>DSS</sub>	Zero Gate Voltage Drain Current	V <sub>DS</sub> =24V, V <sub>GS</sub> =0V	-	-	1	μA
		T <sub>J</sub> =85°C	-	-	30	
V <sub>GS(th)</sub>	Gate Threshold Voltage	V <sub>DS</sub> =V <sub>GS</sub> , I <sub>DS</sub> =250μA	1.3	1.6	2.5	V
I <sub>GSS</sub>	Gate Leakage Current	V <sub>GS</sub> =±20V, V <sub>DS</sub> =0V	-	-	±100	nA
R <sub>DS(ON)</sub> <sup>e</sup>	Drain-Source On-state Resistance	V <sub>GS</sub> =10V, I <sub>DS</sub> =25A	-	0.9	1.1	mΩ
		V <sub>GS</sub> =4.5V, I <sub>DS</sub> =15A	-	1.3	1.7	
G <sub>fs</sub>	Forward Transconductance	V <sub>DS</sub> =5V, I <sub>DS</sub> =20A	-	35	-	S
<b>Diode Characteristics</b>						
V <sub>SD</sub> <sup>e</sup>	Diode Forward Voltage	I <sub>SD</sub> =25A, V <sub>GS</sub> =0V	-	0.75	1.1	V
t <sub>rr</sub>	Reverse Recovery Time	I <sub>SD</sub> =25A, dI <sub>SD</sub> /dt=100A/μs V <sub>DS</sub> =15V	-	74	-	ns
t <sub>a</sub>	Charge Time		-	37.5	-	
t <sub>b</sub>	Discharge Time		-	36.5	-	
Q <sub>rr</sub>	Reverse Recovery Charge		-	95.5	-	
<b>Dynamic Characteristics</b>						
R <sub>G</sub>	Gate Resistance	V <sub>GS</sub> =0V, V <sub>DS</sub> =0V, F=1MHz	-	1	2.2	Ω
C <sub>iss</sub>	Input Capacitance	V <sub>GS</sub> =0V, V <sub>DS</sub> =15V, Frequency=1.0MHz	-	5165	-	pF
C <sub>oss</sub>	Output Capacitance		-	3800	-	
C <sub>rss</sub>	Reverse Transfer Capacitance		-	260	-	
t <sub>d(ON)</sub>	Turn-on Delay Time	V <sub>DD</sub> =15V, R <sub>L</sub> =15Ω, I <sub>DS</sub> =1A, V <sub>GEN</sub> =10V, R <sub>G</sub> =1Ω	-	20.6	-	ns
t <sub>r</sub>	Turn-on Rise Time		-	11.6	-	
t <sub>d(OFF)</sub>	Turn-off Delay Time		-	53.5	-	
t <sub>f</sub>	Turn-off Fall Time		-	81.7	-	
<b>Gate Charge Characteristics</b>						
Q <sub>g</sub>	Total Gate Charge	V <sub>DS</sub> =15V, V <sub>GS</sub> =10V, I <sub>DS</sub> =25A	-	76	99	nC
Q <sub>g</sub>	Total Gate Charge	V <sub>DS</sub> =15V, V <sub>GS</sub> =4.5V, I <sub>DS</sub> =25A	-	37	-	
Q <sub>gth</sub>	Threshold Gate Charge		-	6.7	-	
Q <sub>gs</sub>	Gate-Source Charge		-	12	-	
Q <sub>gd</sub>	Gate-Drain Charge		-	11	-	

Note e : Pulse test ; pulse width≤300μs, duty cycle≤2%.

## Typical Operating Characteristics

Power Dissipation

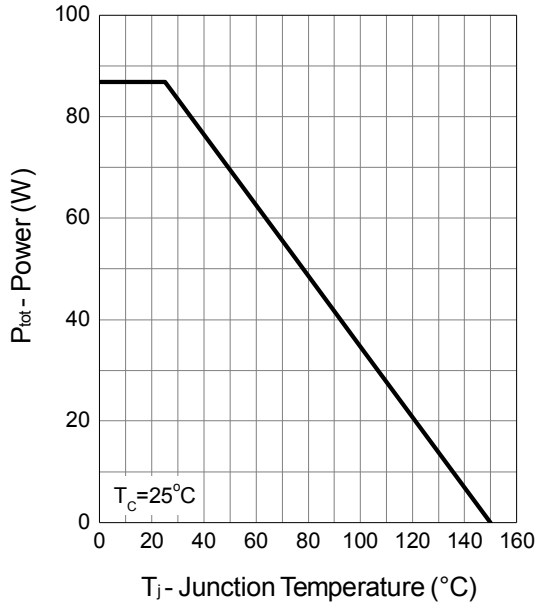

Drain Current

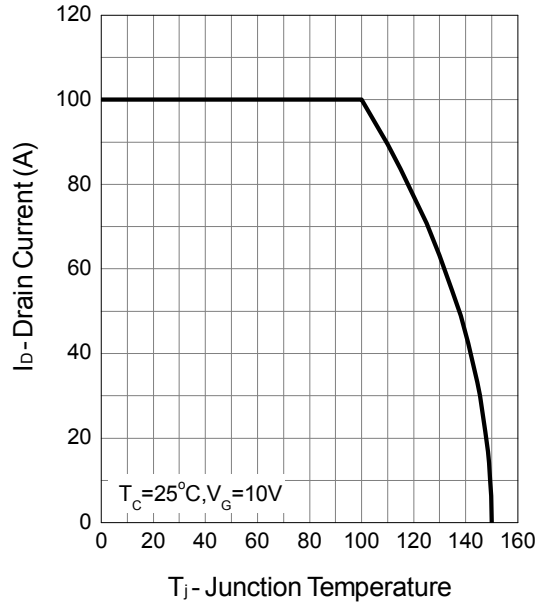

Safe Operation Area

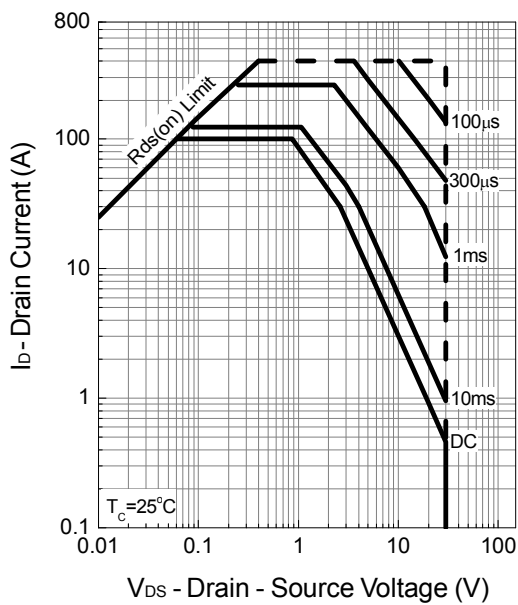

Thermal Transient Impedance

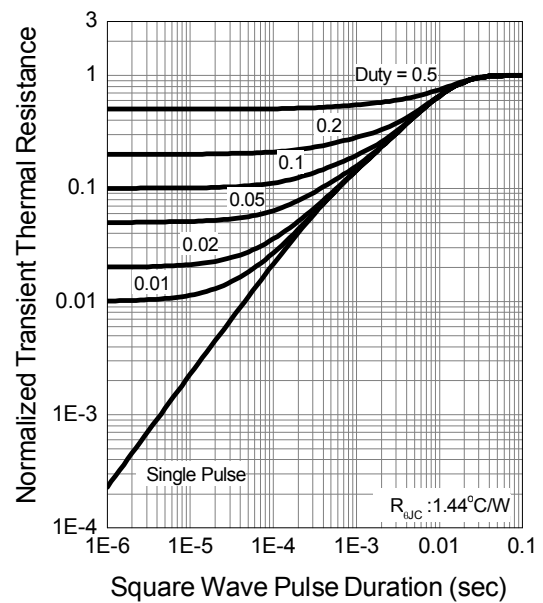

Typical Operating Characteristics (Cont.)

Safe Operation Area

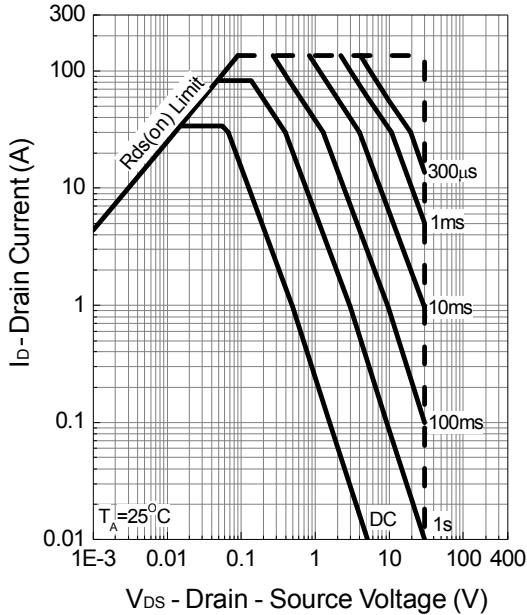

Thermal Transient Impedance

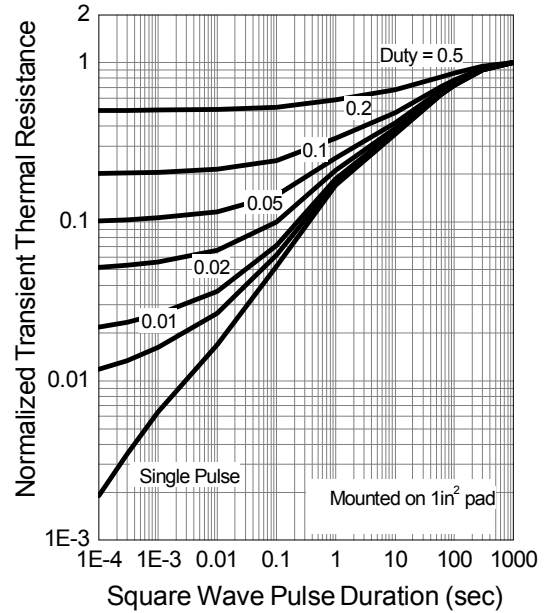

Output Characteristics

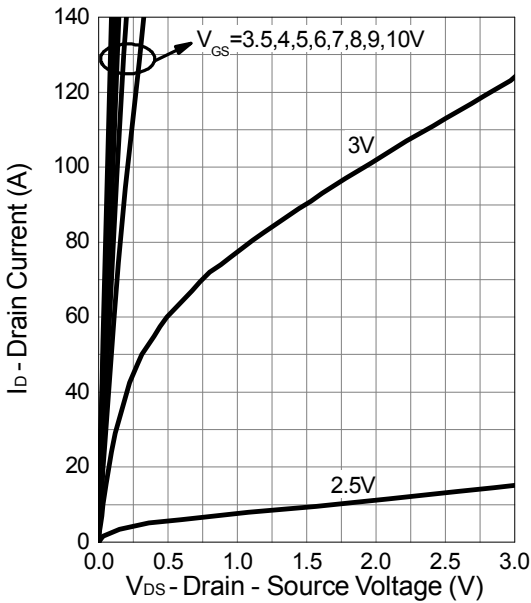

Drain-Source On Resistance

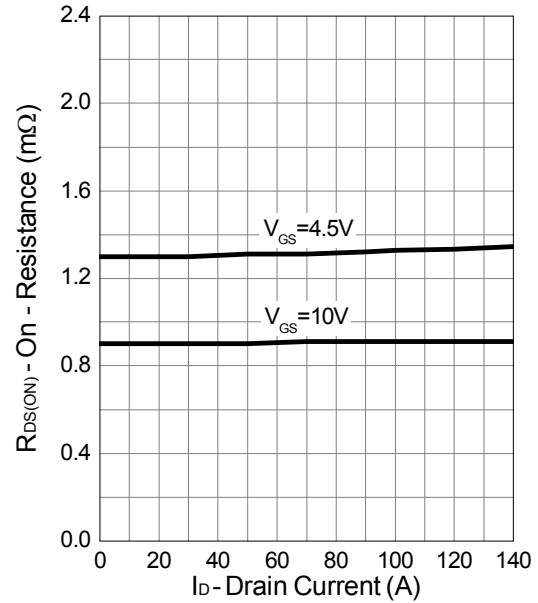

Typical Operating Characteristics (Cont.)

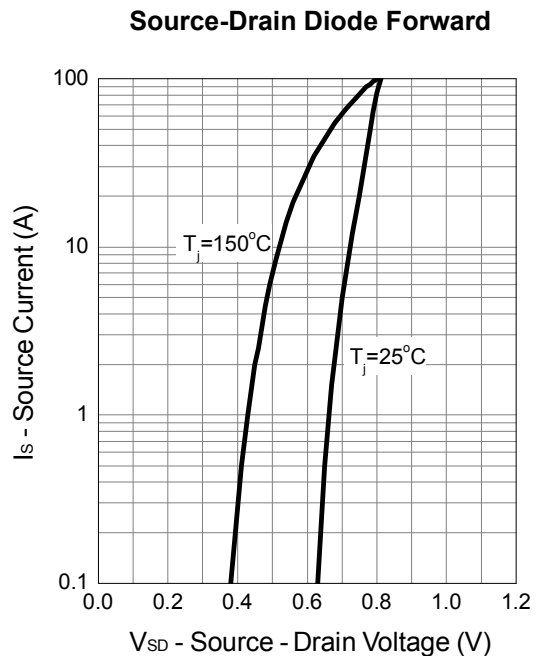
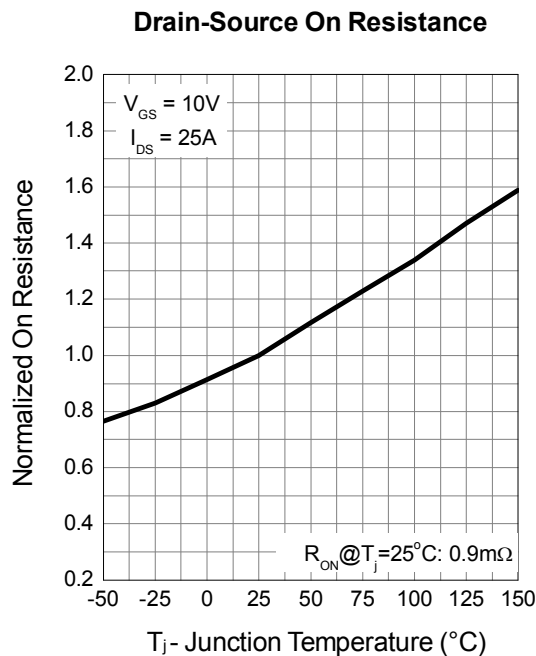
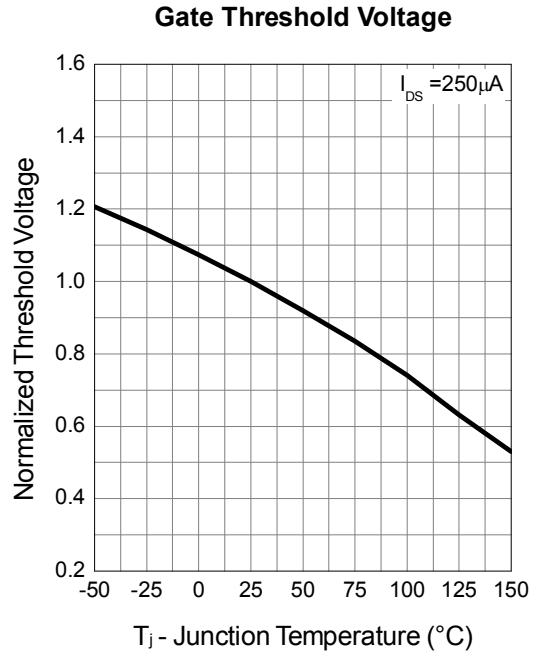
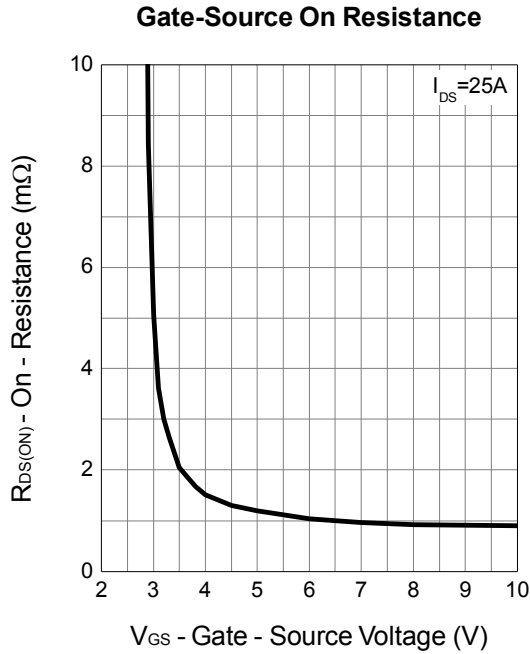

Typical Operating Characteristics (Cont.)

Capacitance

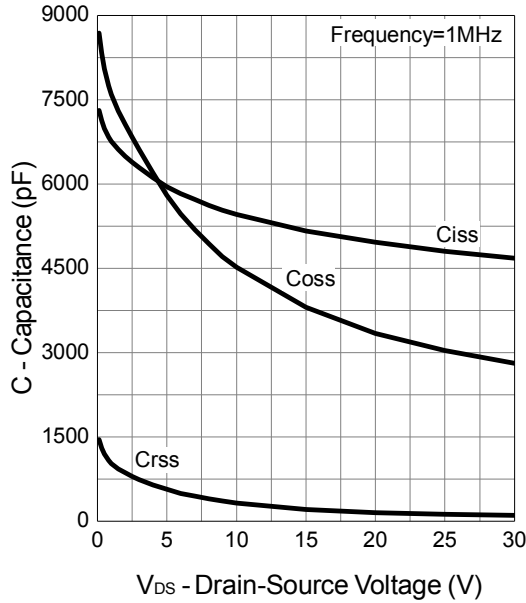

Gate Charge

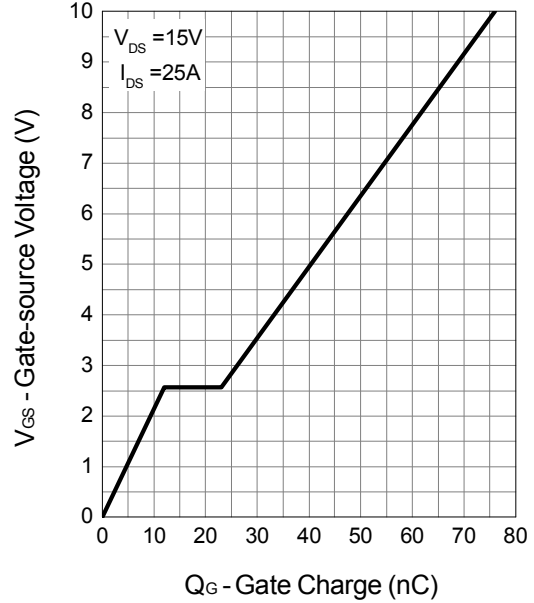

Transfer Characteristics

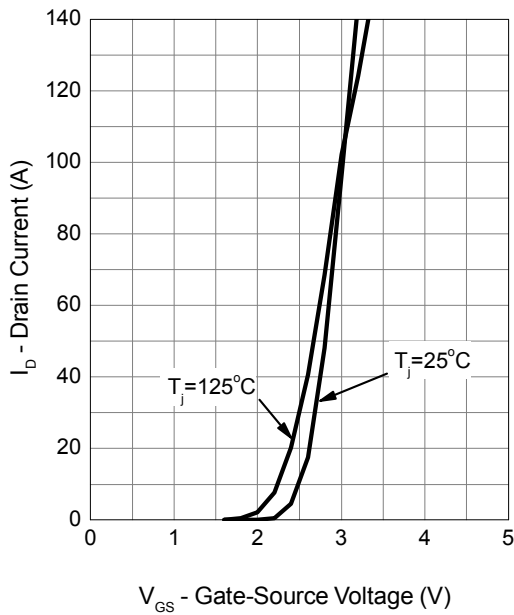

### Avalanche Test Circuit and Waveforms

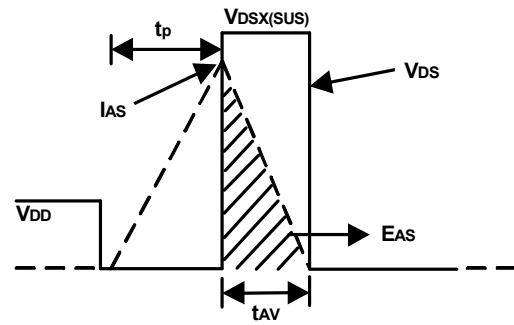
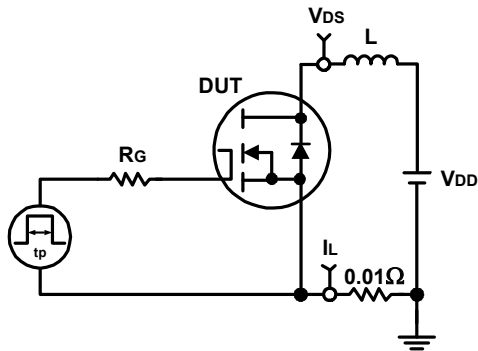

### Switching Time Test Circuit and Waveforms

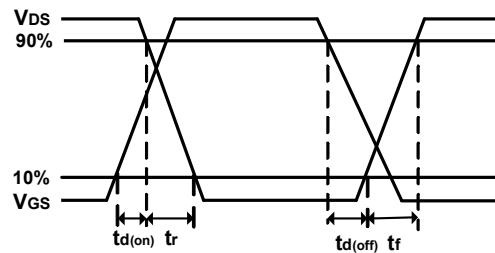
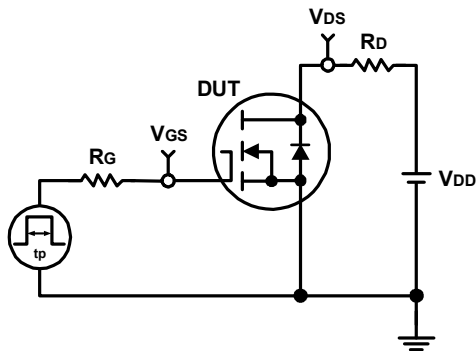



## Disclaimer

Sinopower Semiconductor, Inc. (hereinafter “Sinopower”) has been making great efforts to development high quality and better performance products to satisfy all customers’ needs. However, a product may fail to meet customer’s expectation or malfunction for various situations.

All information which is shown in the datasheet is based on Sinopower’s research and development result, therefore, Sinopower shall reserve the right to adjust the content and monitor the production.

In order to unify the quality and performance, Sinopower has been following JEDEC while defines assembly rule. Notwithstanding all the suppliers basically follow the rule for each product, different processes may cause slightly different results.

The technical information specified herein is intended only to show the typical functions of and examples of application circuits for the products. Sinopower does not grant customers explicitly or implicitly, any license to use or exercise intellectual property or other rights held by Sinopower and other parties. Sinopower shall bear no responsible whatsoever for any dispute arising from the use of such technical information.

The products are not designed or manufactured to be used with any equipment, device or system which requires an extremely high level of reliability, such as the failure or malfunction of which any may result in a direct threat to human life or a risk of human injury. Sinopower shall bear no responsibility in any way for use of any of the products for the above special purposes. If a product is intended to use for any such special purpose, such as vehicle, military, or medical controller relevant applications, please contact Sinopower sales representative before purchasing.

Classification Profile

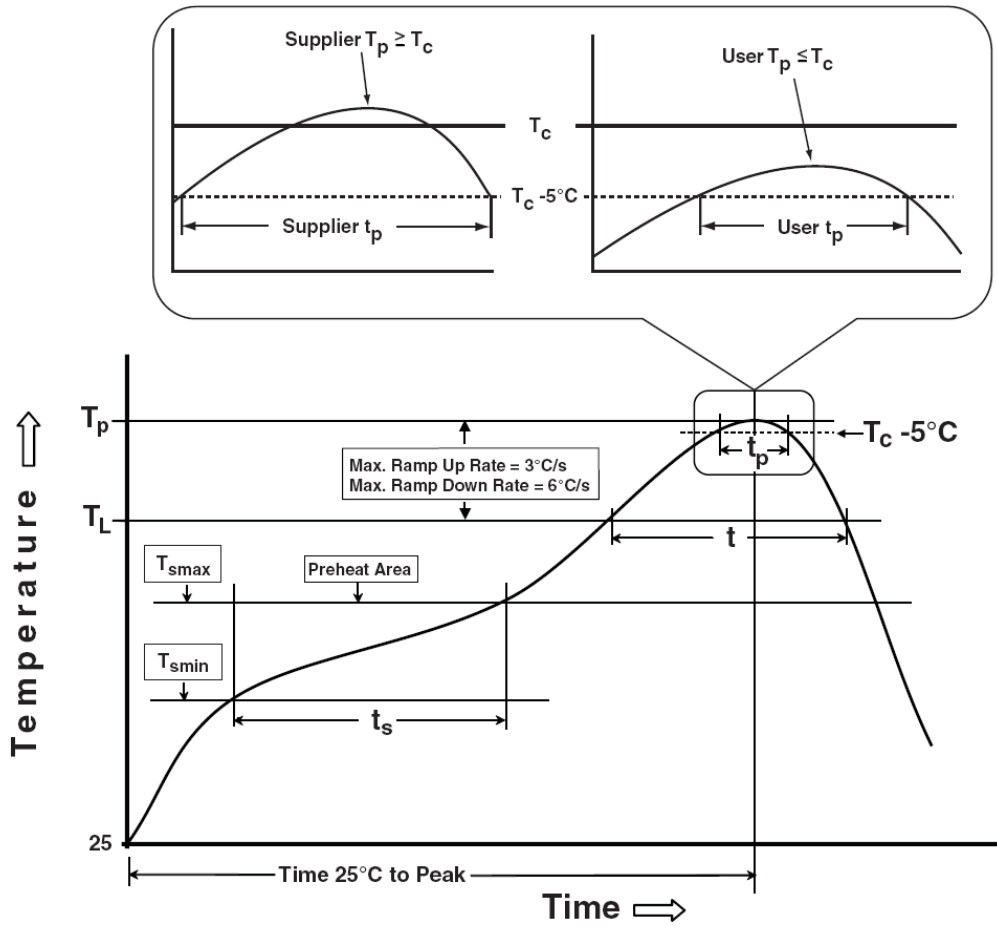

## Classification Reflow Profiles

Profile Feature	Sn-Pb Eutectic Assembly	Pb-Free Assembly
<b>Preheat &amp; Soak</b>		
Temperature min ( $T_{smin}$ )	100 °C	150 °C
Temperature max ( $T_{smax}$ )	150 °C	200 °C
Time ( $T_{smin}$ to $T_{smax}$ ) ( $t_s$ )	60-120 seconds	60-120 seconds
Average ramp-up rate ( $T_{smax}$ to $T_p$ )	3 °C/second max.	3°C/second max.
Liquidous temperature ( $T_L$ )	183 °C	217 °C
Time at liquidous ( $t_L$ )	60-150 seconds	60-150 seconds
Peak package body Temperature ( $T_p$ )*	See Classification Temp in table 1	See Classification Temp in table 2
Time ( $t_p$ )** within 5°C of the specified classification temperature ( $T_c$ )	20** seconds	30** seconds
Average ramp-down rate ( $T_p$ to $T_{smax}$ )	6 °C/second max.	6 °C/second max.
Time 25°C to peak temperature	6 minutes max.	8 minutes max.
* Tolerance for peak profile Temperature ( $T_p$ ) is defined as a supplier minimum and a user maximum.		
** Tolerance for time at peak profile temperature ( $t_p$ ) is defined as a supplier minimum and a user maximum.		

Table 1. SnPb Eutectic Process – Classification Temperatures ( $T_c$ )

Package Thickness	Volume mm <sup>3</sup> <350	Volume mm <sup>3</sup> ≥350
<2.5 mm	235 °C	220 °C
≥2.5 mm	220 °C	220 °C

Table 2. Pb-free Process – Classification Temperatures ( $T_c$ )

Package Thickness	Volume mm <sup>3</sup> <350	Volume mm <sup>3</sup> 350-2000	Volume mm <sup>3</sup> >2000
<1.6 mm	260 °C	260 °C	260 °C
1.6 mm – 2.5 mm	260 °C	250 °C	245 °C
≥2.5 mm	250 °C	245 °C	245 °C

## Reliability Test Program

Test item	Method	Description
SOLDERABILITY	JESD-22, B102	5 Sec, 245°C
HTRB	JESD-22, A108	1000 Hrs, 80% of VDS max @ $T_{jmax}$
HTGB	JESD-22, A108	1000 Hrs, 100% of VGS max @ $T_{jmax}$
PCT	JESD-22, A102	168 Hrs, 100%RH, 2atm, 121°C
TCT	JESD-22, A104	500 Cycles, -65°C~150°C

## Customer Service

### Sinopower Semiconductor, Inc.

5F, No. 6, Dusing 1St Rd., Hsinchu Science Park,

Hsinchu, 30078, Taiwan

TEL: 886-3-5635818 Fax: 886-3-5635080