

RoHS Compliant Product
A suffix of "-C" specifies halogen & lead-free

FEATURES

- Metal silicon junction, majority carrier conduction
- For surface mounted applications
- Low power loss, high efficiency
- High forward surge current capability
- For use in low voltage, high frequency inverters, free wheeling, and polarity protection applications

MECHANICAL DATA

- Case: SMAM
- Terminals: Solderable per MIL-STD-750, Method 2026
- Weight: 27mg (Approximate)

MARKING

Part Number	Marking Code	Part Number	Marking Code
SM520AM-C	SS54	SM5100AM-C	SS510
SM540AM-C	SS54	SM5150AM-C	SS515
SM560AM-C	SS56	SM5200AM-C	SS520

PACKAGE INFORMATION

Package	MPQ	Leader Size
SMAM	3K	7 inch

ORDER INFORMATION

Part Number	Type
SM520AM-C~SM5200AM-C	Lead (Pb)-free and Halogen-free

ABSOLUTE MAXIMUM RATINGS

(Rating 25°C ambient temperature unless otherwise specified. Single phase half wave, 60Hz, resistive or inductive load.
For capacitive load, de-rate current by 20%.)

Parameter	Symbol	Part Number						Unit
		SM520 AM-C	SM540 AM-C	SM560 AM-C	SM5100 AM-C	SM5150 AM-C	SM5200 AM-C	
Maximum Repetitive Peak Reverse Voltage	V_{RRM}	20	40	60	100	150	200	V
Maximum RMS Voltage	V_{RMS}	14	28	42	70	105	140	V
Maximum DC Blocking Voltage	V_{DC}	20	40	60	100	150	200	V
Maximum Average Forward Rectified Current	I_F	5						A
Peak Forward Surge Current, 8.3ms single half sine-wave superimposed on rated load	I_{FSM}	150						A
Maximum Instantaneous Forward Voltage $I_F=5A @ 25^\circ C$	V_F	0.55		0.7		0.85		V
Maximum DC Reverse Current at Rated DC Blocking Voltage	$T_A=25^\circ C$	1						mA
	$T_A=100^\circ C$	50						
Typical Junction Capacitance ¹	C_J	500			300		pF	
Typical Thermal Resistance ²	$R_{\theta JL}$	22						°C/W
Operating & Storage Temperature	T_J, T_{STG}	-55~150						°C

Notes:

1. Measured at 1MHz and applied reverse voltage of 4V D.C.
2. P.C.B. mounted with 10 X 10 x 0.2 mm copper pad areas.

SMAM

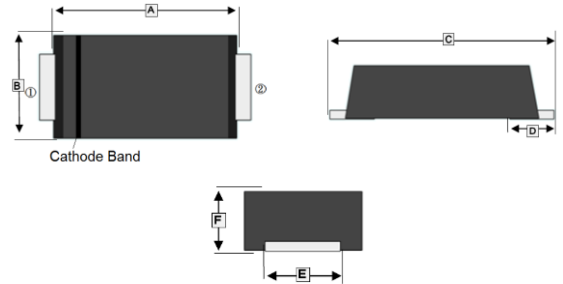

REF.	Millimeter		REF.	Millimeter	
	Min.	Max.		Min.	Max.
A	3.20	3.70	D	1 TYP.	
B	2.40	2.80	E	1.30	1.60
C	4.40	4.90	F	0.90	1.20

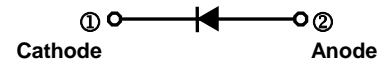

Mounting Pad Layout

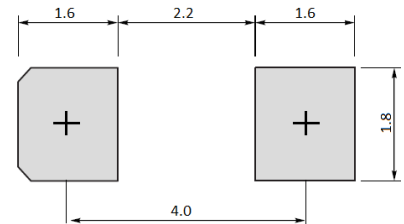

*Dimensions in millimeters

RATINGS AND CHARACTERISTIC CURVES

Fig.1 Forward Current Derating Curve

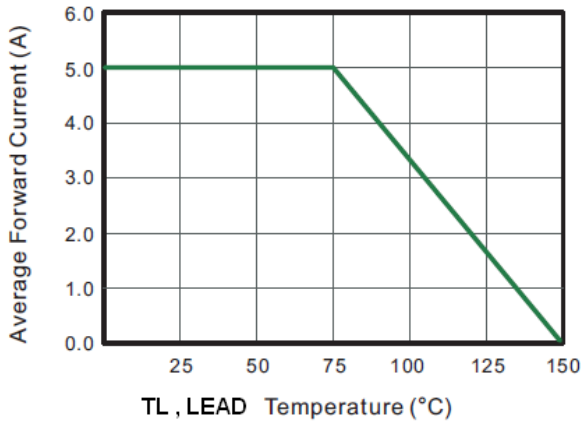

Fig.2 Typical Reverse Characteristics

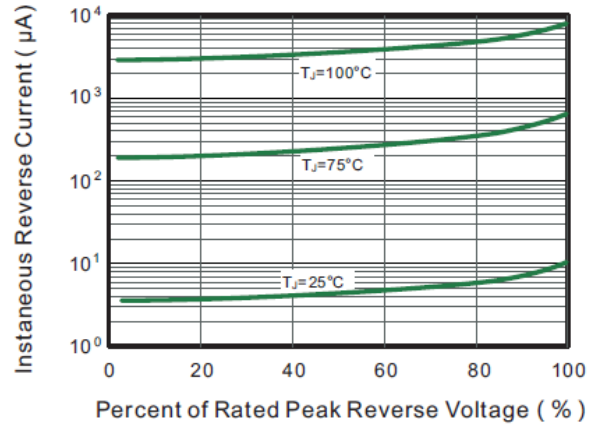

Fig.3 Typical Forward Characteristic

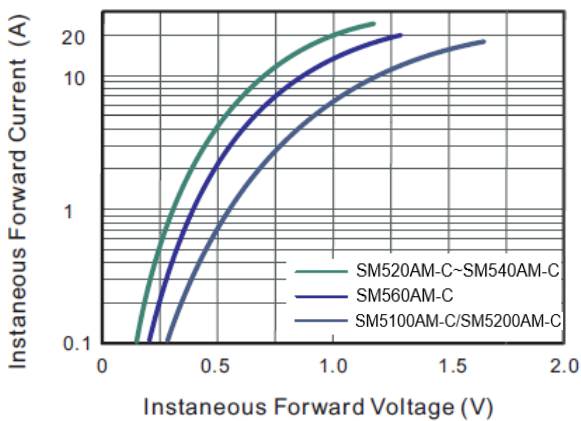

Fig.4 Typical Junction Capacitance

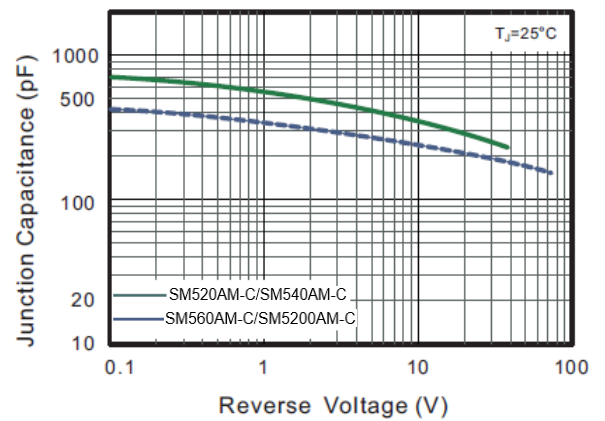

Fig.5 Maximum Non-Repetitive Peak Forward Surge Current

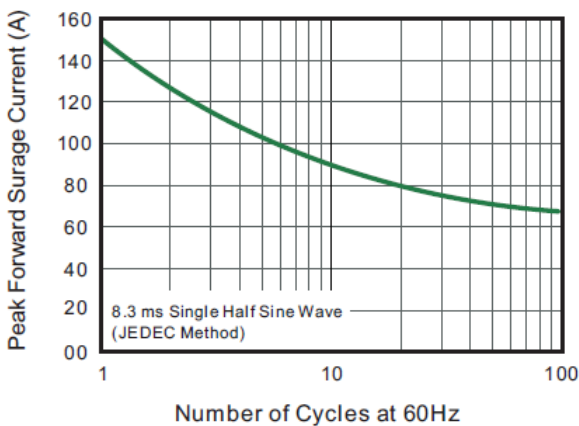

Fig.6- Typical Transient Thermal Impedance

