

SMD GATE DRIVE TRANSFORMERS

SM580 Series & SM76760

Features

- Low Profile Surface Mount Design
- Metal Cover Gives Improved EMI Shielding
- Operating Temp. -40°C to +130°C
- Tinned Leads with Leaded Solder is Available (Note 4)

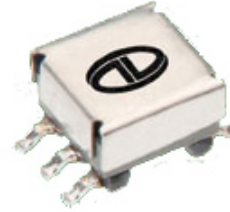

Part Number	Turns Ratio $\pm 1\%$	Primary Inductance (μH MIN)	Leakage Inductance (μH MAX)	DCR Primary (Ω MAX)	DCR Secondary (Ω MAX)	V μS (Typ)	HIPOT Pri-Sec	Schematic
SM580-1	1 : 1	330	2.2 (1-6) short (3-4)	2.8	3.2	21	1500	B
SM580-2	1 : 1.5	330	2.2 (1-6) short (3-4)	2.8	4.2	21	1500	B
SM580-3	1 : 1 : 1	330	2.2 (1-6) short (2-5) & (3-4)	2.8	2.8 (2-5) & (3-4)	21	1500 ⁶	A
SM76760	2 : 1 : 1	330	2.2 (1-6) short (2-5) & (3-4)	2.0	1.2 (2-5) & (3-4)	22.2	1500 ⁶	A

MECHANICAL OUTLINE

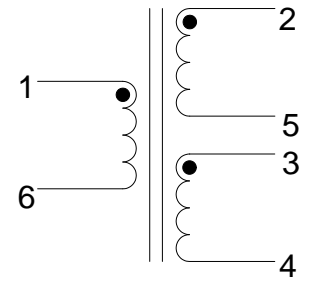
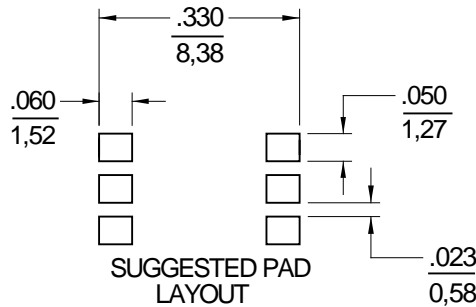
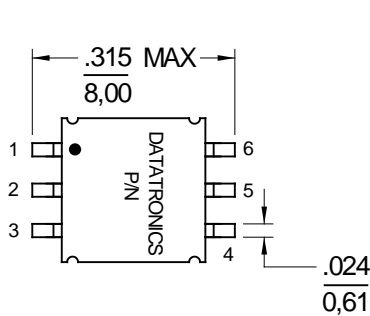

SCHEMATIC A

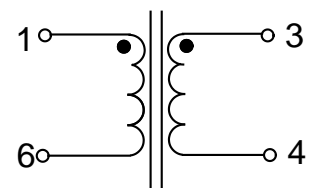
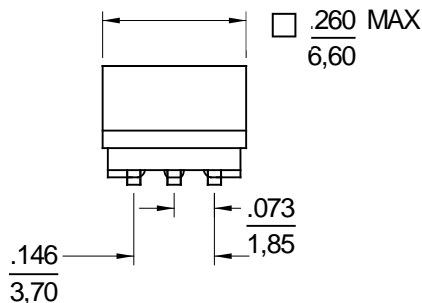
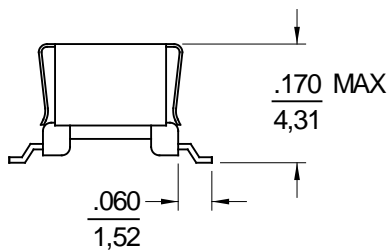

SCHEMATIC B

Notes:

1. All dimensions are in inches/mm
2. Unless otherwise specified, tolerance is $\pm .010/0,25$
3. Coplanarity is $0.004/0,102$
4. For non-RoHS parts replace the SM prefix with 42- (e.g. SM580-1 becomes 42-580-1)
5. Terminal finish is compliant to ROHS requirements. Solder in accordance with J-STD-020D
6. Secondary HIPOT 500 VDC between winding on SM580-3 & SM76760