

RoHS Compliant Product

Description

The SM6201 series are highly precise, low power consumption, positive voltage regulators manufactured using CMOS and laser trimming technologies. The series provide large currents with a significantly small dropout voltage. The SM6201 consists of a current limiter circuit, a driver transistor, a precision reference voltage and an error amplifier. Output voltage is selectable in 0.1V steps between 1.3~6.0V.

Features

- * Max. Operating Voltage: 10V
- * Highly Accurate: Output Voltage $\pm 2\%$
- * Low Power Consumption: Typ. 2 μ A
- * Output Voltage Range: 1.3V~6V (selectable in 0.1V steps)
- * Dropout Voltage: 0.16V@ $I_{OUT}=100mA$
- * Output Voltage Temperature Characteristics: Typ. $\pm 100ppm/^{\circ}C$
- * Max. Output Current: 250mA (Typ.)
- * Capacitors Can Be Tantalum Or Ceramic

SOT-89

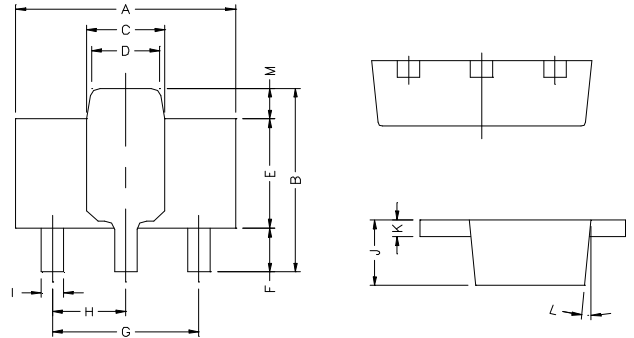

REF.	Millimeter		REF.	Millimeter	
	Min.	Max.		Min.	Max.
A	4.4	4.6	G	3.00	REF.
B	4.05	4.25	H	1.50	REF.
C	1.50	1.70	I	0.40	0.52
D	1.30	1.50	J	1.40	1.60
E	2.40	2.60	K	0.35	0.41
F	0.89	1.20	L	5° TYP.	
			M	0.70 REF.	

Applications

- * Reference Voltage
- * Portable Games And AV Equipment
- * Battery Powered Equipment
- * Cameras, Video Recorders
- * Mobile Phones And Cordless Phones

Marking :

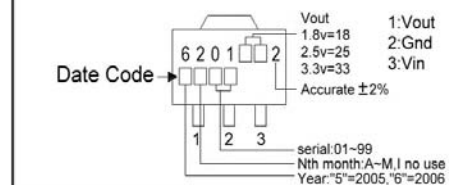

Block Diagram

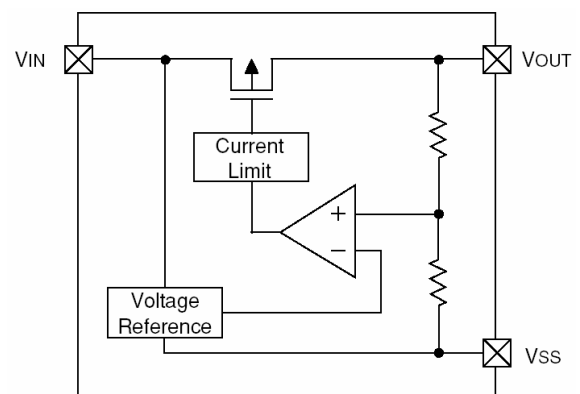

Typical Application Circuit

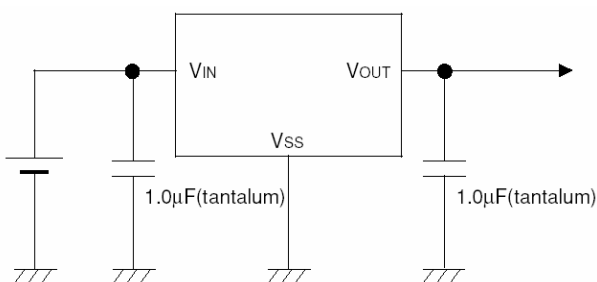

Absolute Maximum Ratings $T_a=25^\circ\text{C}$

Parameter	Symbol	Ratings	Unit
Input Voltage	V_{IN}	12	V
Output Current	I_{OUT}	500	mA
Output Voltage	V_{OUT}	$V_{SS}-0.3\sim V_{IN}+0.3$	V
Operating Ambient Temperature	T_{opr}	-40~+85	$^\circ\text{C}$
Storage Temperature	T_{stg}	-55~+125	$^\circ\text{C}$
Continuous Total Power Dissipation	P_d	500	mW

Electrical Characteristics $T_a=25^\circ\text{C}$

SM6201-50 $V_{OUT}(T) = 5.0\text{V}$ (Note1)

Parameter	Symbol	Condition	Min	TYP	Max	Unit
Output Voltage	$V_{OUT(E)}$ (Note2)	$V_{IN}=6.0\text{V}$, $I_{OUT}=40\text{mA}$	4.900	5.000	5.100	V
Max. Output Current	$I_{OUT\ max}$	$V_{IN}=6\text{V}$, $V_{OUT(E)}\geq 4.5\text{V}$	200	-	-	mA
Load Regulation	ΔV_{OUT}	$V_{IN}=6\text{V}$, $I_{OUT}=1\text{mA}$ to 100mA	-	30	70	mV
Dropout Voltage (Note3)	V_{dif1}	$I_{OUT}=100\text{mA}$	-	160	340	mV
	V_{dif2}	$I_{OUT}=200\text{mA}$	-	400	600	
Supply Current	I_{SS}	$V_{IN}=6\text{V}$	-	2.0	6.0	μA
Input Regulation	$\frac{\Delta V_{OUT}}{\Delta V_{IN}\cdot V_{OUT}}$	$I_{OUT}=40\text{mA}$ $V_{IN}=6\text{V}$ to 10V	-	0.2	0.3	%/V
Input Voltage	V_{IN}		1.8	-	10	V
Output Voltage Temperature Characteristics	$\frac{\Delta V_{OUT}}{\Delta T_{opr}\cdot V_{OUT}}$	$I_{OUT}=40\text{mA}$ $-40^\circ\text{C}\leq T_{opr}\leq 85^\circ\text{C}$	-	± 100	-	ppm/ $^\circ\text{C}$

Note 1: $V_{OUT}(T)$ =Specified Output Voltage.

2: $V_{OUT}(E)$ =Effective Output Voltage (i.e. the output voltage when " $V_{OUT}(T) + 1.0\text{V}$ " is provided while maintaining a certain I_{OUT}

www.DataSheet4U.com

3: $V_{dif} = \{V_{IN1}^{(Note5)} - V_{OUT1}^{(Note4)}\}$

4: V_{OUT1} =A voltage equal to 98% of the output voltage when a stabilized ($V_{OUT}(T) + 1.0\text{V}$) is output.

5: V_{IN1} =The input voltage at the time V_{OUT1} is output (input voltage has been gradually reduced).

SM6201-33 $V_{OUT}(T) = 3.3\text{V}$ (Note1)

Parameter	Symbol	Condition	Min	TYP	Max	Unit
Output Voltage	$V_{OUT(E)}$ (Note2)	$V_{IN}=4.3\text{V}$, $I_{OUT}=40\text{mA}$	3.234	3.300	3.366	V
Max. Output Current	$I_{OUT\ max}$	$V_{IN}=4.3\text{V}$, $V_{OUT(E)}\geq 2.97\text{V}$	150	-	-	mA
Load Regulation	ΔV_{OUT}	$V_{IN}=4.3\text{V}$, $I_{OUT}=1\text{mA}$ to 80mA	-	20	50	mV
Dropout Voltage (Note3)	V_{dif1}	$I_{OUT}=80\text{mA}$	-	200	360	mV
	V_{dif2}	$I_{OUT}=160\text{mA}$	-	450	700	
Supply Current	I_{SS}	$V_{IN}=4.3\text{V}$	-	2.0	5.0	μA
Input Regulation	$\frac{\Delta V_{OUT}}{\Delta V_{IN}\cdot V_{OUT}}$	$I_{OUT}=40\text{mA}$ $V_{IN}=4.3\text{V}$ to 10V	-	0.2	0.3	%/V
Input Voltage	V_{IN}		1.8	-	10	V
Output Voltage Temperature Characteristics	$\frac{\Delta V_{OUT}}{\Delta T_{opr}\cdot V_{OUT}}$	$I_{OUT}=40\text{mA}$ $-40^\circ\text{C}\leq T_{opr}\leq 85^\circ\text{C}$	-	± 100	-	ppm/ $^\circ\text{C}$

SM6201-27 V_{OUT} (T) =2.7V (Note1)

Parameter	Symbol	Condition	Min	TYP	Max	Unit
Output Voltage	V _{OUT(E)} (Note2)	V _{IN} =3.7V, I _{OUT} =40mA	2.646	2.700	2.754	V
Max. Output Current	I _{OUT max}	V _{IN} =3.7V, V _{OUT(E)} ≥2.43V	100	-	-	mA
Load Regulation	ΔV _{OUT}	V _{IN} =3.7V, I _{OUT} =1mA to 60mA	-	15	40	mV
Dropout Voltage (Note3)	V _{dif1}	I _{OUT} =60mA	-	200	370	mV
	V _{dif2}	I _{OUT} =120mA	-	450	710	
Supply Current	I _{SS}	V _{IN} =3.7V	-	2.0	5.0	μA
Input Regulation	$\frac{\Delta V_{OUT}}{\Delta V_{IN} \cdot V_{OUT}}$	I _{OUT} =40mA V _{IN} =3.7V to 10V	-	0.2	0.3	%/V
Input Voltage	V _{IN}		1.8	-	10	V
Output Voltage Temperature Characteristics	$\frac{\Delta V_{OUT}}{\Delta T_{opr} \cdot V_{OUT}}$	I _{OUT} =40mA -40°C ≤ T _{opr} ≤ 85°C	-	±100	-	ppm/°C

SM6201-18 V_{OUT} (T) =1.8V (Note1)

Parameter	Symbol	Condition	Min	TYP	Max	Unit
Output Voltage	V _{OUT(E)} (Note2)	V _{IN} =2.8V, I _{OUT} =40mA	1.764	1.800	1.836	V
Max. Output Current	I _{OUT max}	V _{IN} =2.8V, V _{OUT(E)} ≥1.62V	80	-	-	mA
Load Regulation	ΔV _{OUT}	V _{IN} =2.8V, I _{OUT} =1mA to 60mA	-	10	30	mV
Dropout Voltage (Note3)	V _{dif1}	I _{OUT} =40mA	-	200	370	mV
	V _{dif2}	I _{OUT} =80mA	-	450	710	
Supply Current	I _{SS}	V _{IN} =2.8V	-	3.0	5.0	μA
Input Regulation	$\frac{\Delta V_{OUT}}{\Delta V_{IN} \cdot V_{OUT}}$	I _{OUT} =40mA V _{IN} =2.8V to 10V	-	0.2	0.3	%/V
Input Voltage	V _{IN}		1.8	-	10	V
Output Voltage Temperature Characteristics	$\frac{\Delta V_{OUT}}{\Delta T_{opr} \cdot V_{OUT}}$	I _{OUT} =40mA -40°C ≤ T _{opr} ≤ 85°C	-	±100	-	ppm/°C

www.DataSheet4U.com

SM6201-13 V_{OUT} (T) =1.3V (Note1)

Parameter	Symbol	Condition	Min	TYP	Max	Unit
Output Voltage	V _{OUT(E)} (Note2)	V _{IN} =2.3V, I _{OUT} =40mA	1.274	1.300	1.326	V
Max. Output Current	I _{OUT max}	V _{IN} =2.3V, V _{OUT(E)} ≥1.17V	60	-	-	mA
Load Regulation	ΔV _{OUT}	V _{IN} =2.3V, I _{OUT} =1mA to 30mA	-	10	30	mV
Dropout Voltage (Note3)	V _{dif1}	I _{OUT} =30mA	-	200	600	mV
	V _{dif2}	I _{OUT} =60mA	-	500	810	
Supply Current	I _{SS}	V _{IN} =2.3V	-	3.0	5.0	μA
Input Regulation	$\frac{\Delta V_{OUT}}{\Delta V_{IN} \cdot V_{OUT}}$	I _{OUT} =40mA V _{IN} =2.3V to 10V	-	0.2	0.3	%/V
Input Voltage	V _{IN}		1.8	-	10	V
Output Voltage Temperature Characteristics	$\frac{\Delta V_{OUT}}{\Delta T_{opr} \cdot V_{OUT}}$	I _{OUT} =40mA -40°C ≤ T _{opr} ≤ 85°C	-	±100	-	ppm/°C

Test Circuit

Circuit1

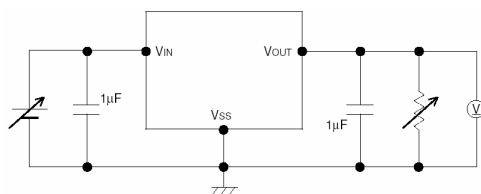

Circuit2

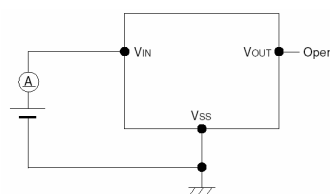

Characteristics Curve

(1) Output Voltage vs. Output Current

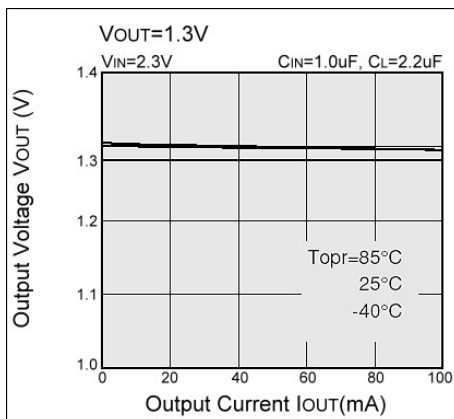
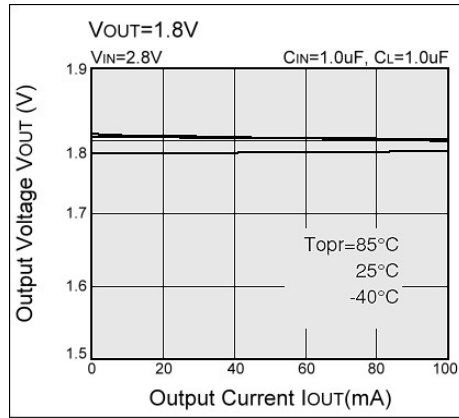
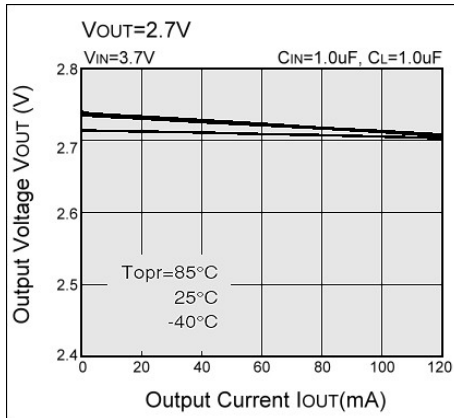
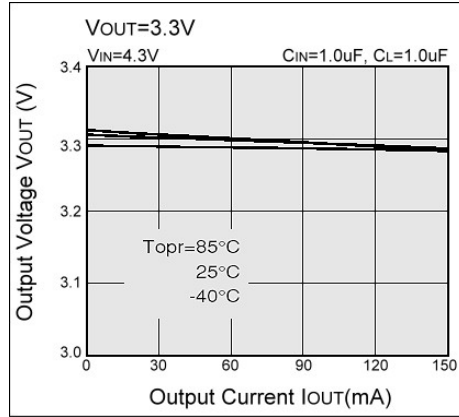
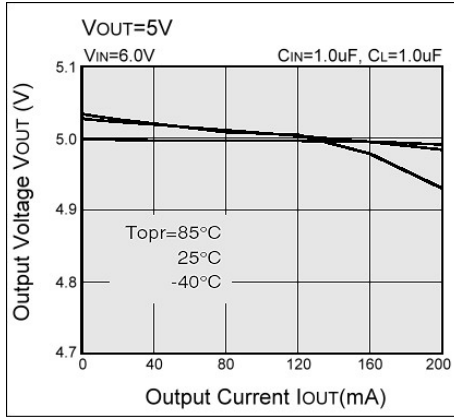

www.DataSheet4U.com

(2) Dropout Voltage vs. Output Current

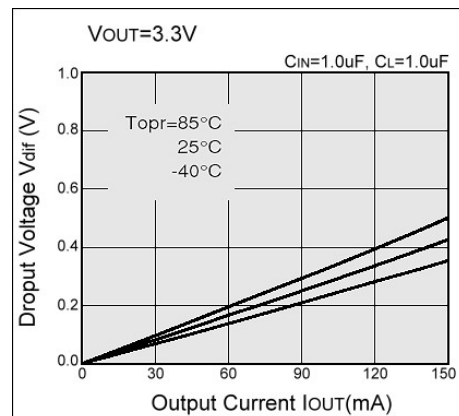
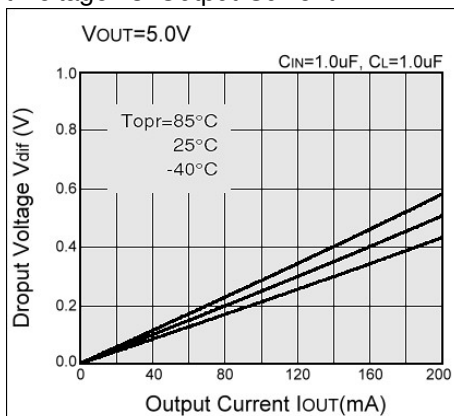

SM6201
CMOS Positive
Voltage Regulator

(2) Dropout Voltage vs. Output Current

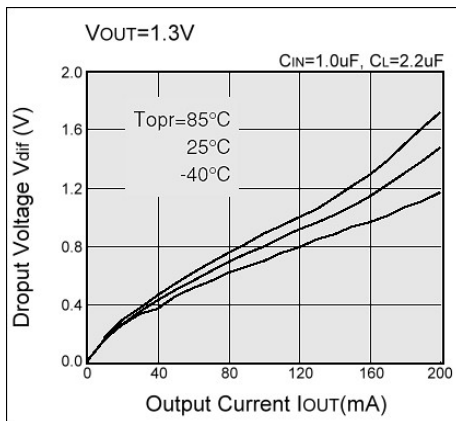
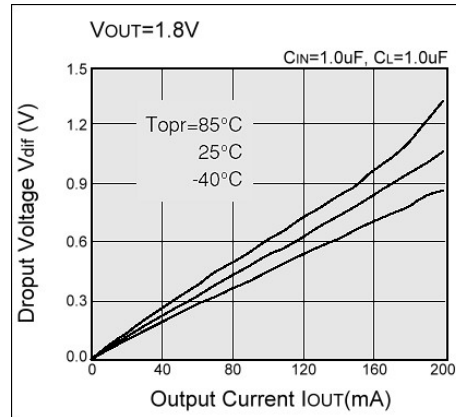
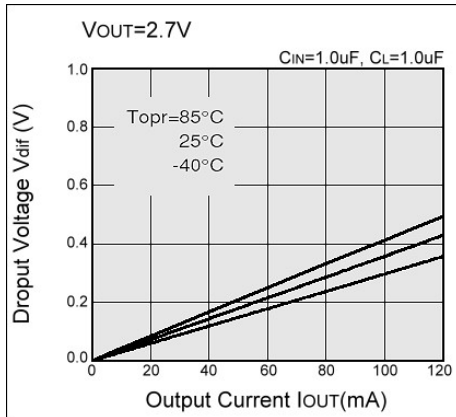

(3) Output Voltage vs. Input Voltage

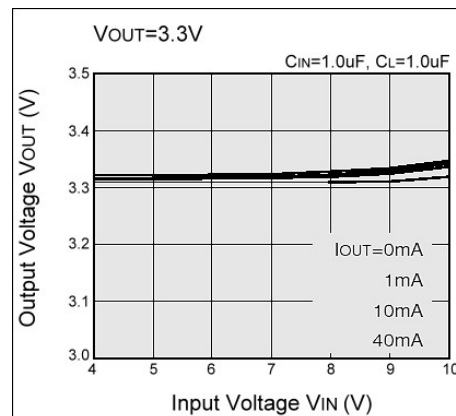
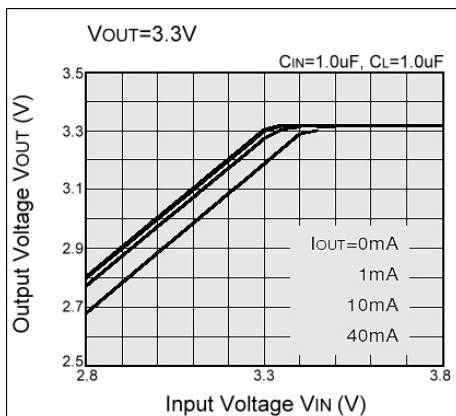
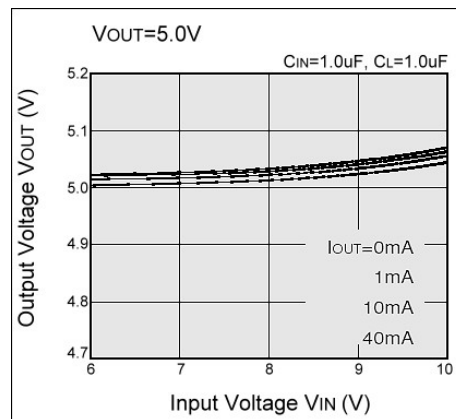
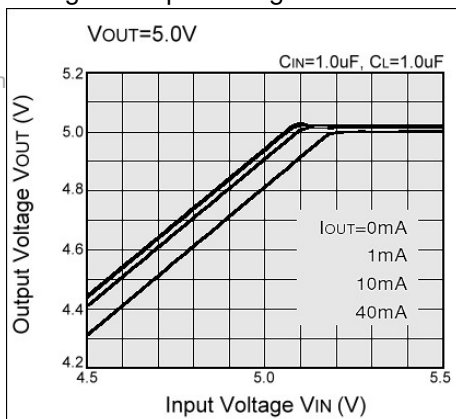

www.DataSheet4U.com

SM6201
CMOS Positive
Voltage Regulator

(3) Output Voltage vs. Input Voltage

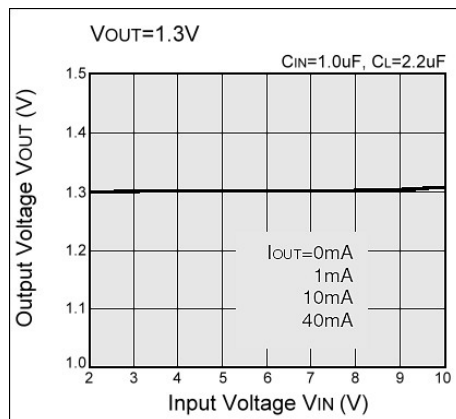
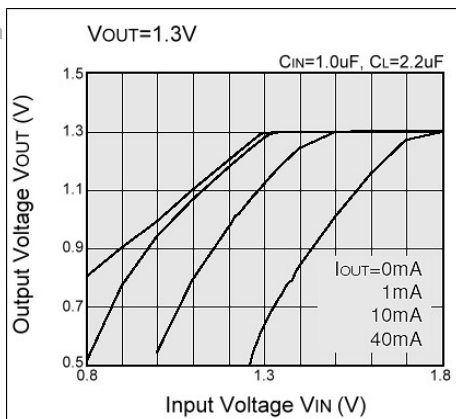
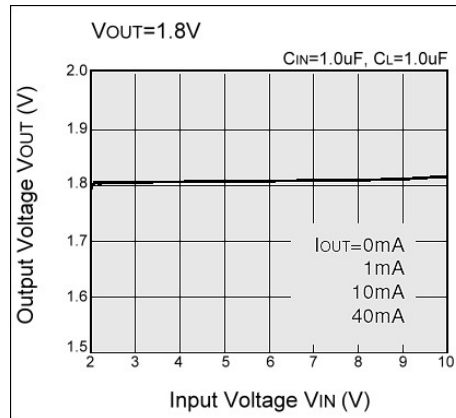
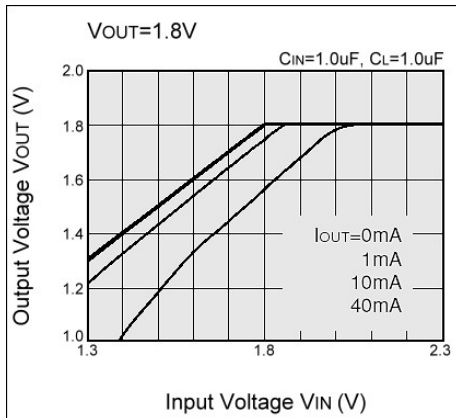
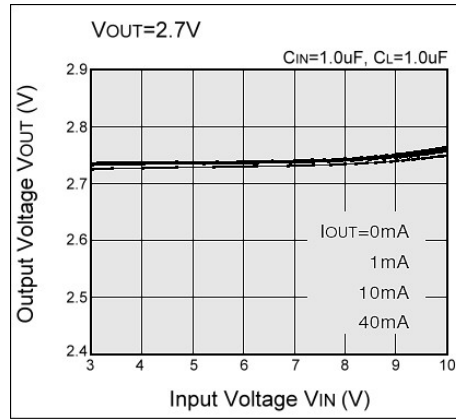
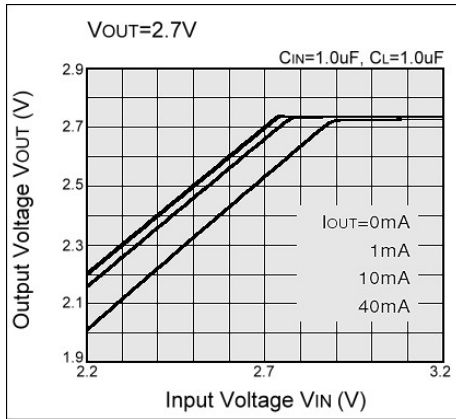

www.DataSheet4U.com

(4) Supply Current vs. Input Voltage

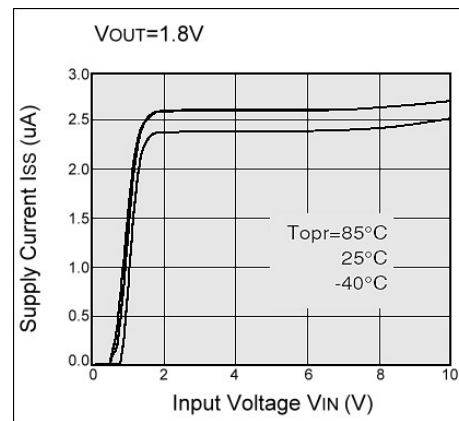
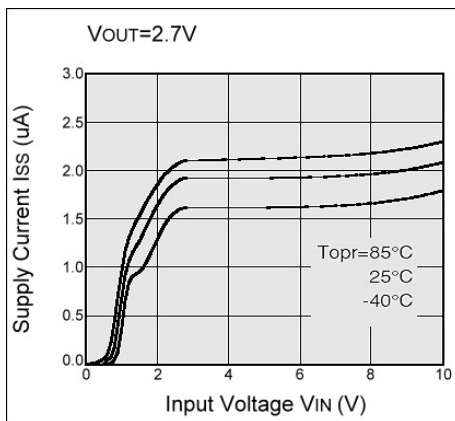
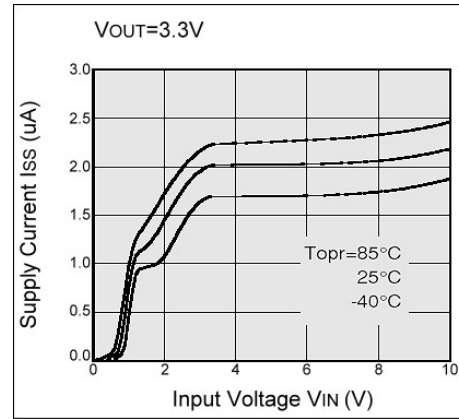
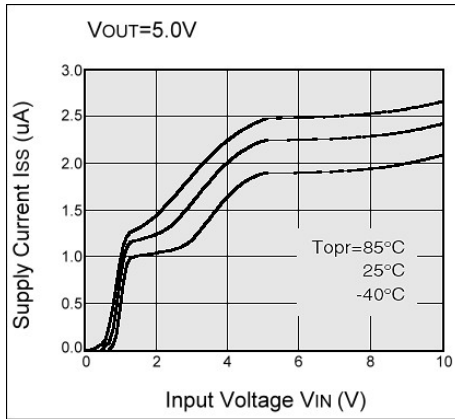

www.DataSheet4U.com

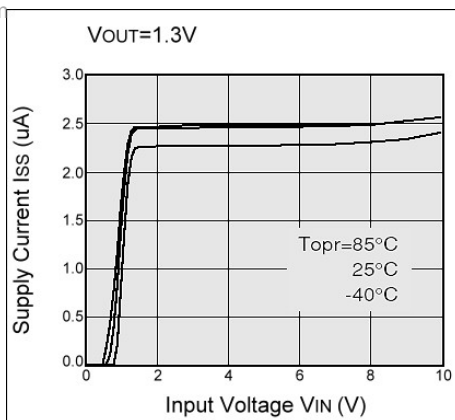

(5) Output Voltage vs. Ambient Temperature

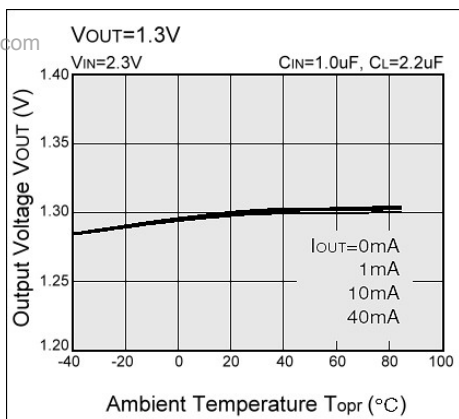
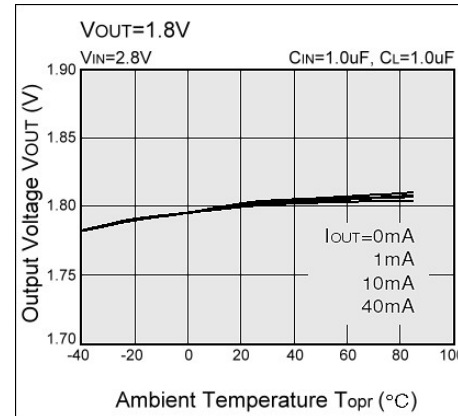
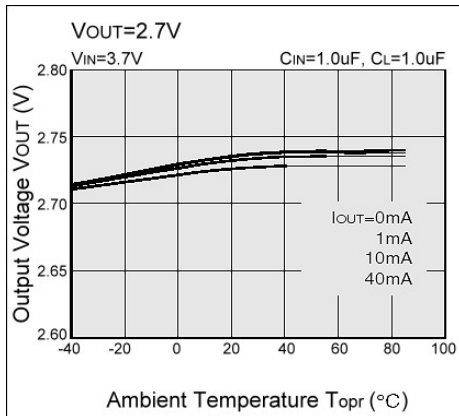
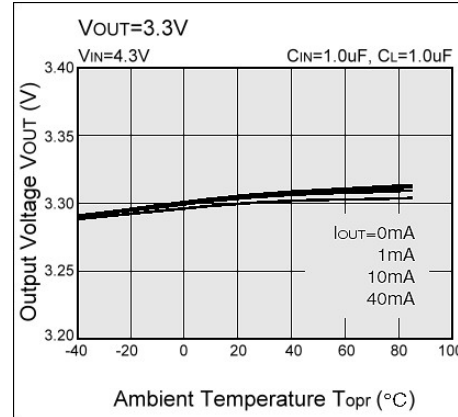
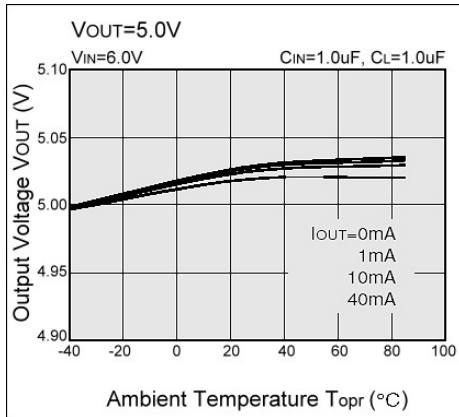

www.DataSheet4U.com