

# SM72238

## SolarMagic Micropower Voltage Regulator

### General Description

The SM72238 is a micropower voltage regulator with very low quiescent current (75µA typ.) and very low dropout voltage (typ. 40mV at light loads and 380mV at 100mA). It is ideally suited for use in battery-powered systems. Furthermore, the quiescent current of the SM72238 increases only slightly in dropout, prolonging battery life.

The SM72238 is available in the surface-mount D-Pak package.

Careful design of the SM72238 has minimized all contributions to the error budget. This includes a tight initial tolerance (.5% typ.), extremely good load and line regulation (.05% typ.) and a very low output voltage temperature coefficient, making the part useful as a low-power voltage reference.

### Features

- Renewable Energy Grade
- High accuracy output voltage
- Guaranteed 100mA output current
- Extremely low quiescent current
- Low dropout voltage
- Extremely tight load and line regulation
- Very low temperature coefficient
- Use as Regulator or Reference
- Needs minimum capacitance for stability
- Current and Thermal Limiting
- Stable with low-ESR output capacitors (10mΩ to 6Ω)



### Block Diagram and Typical Applications

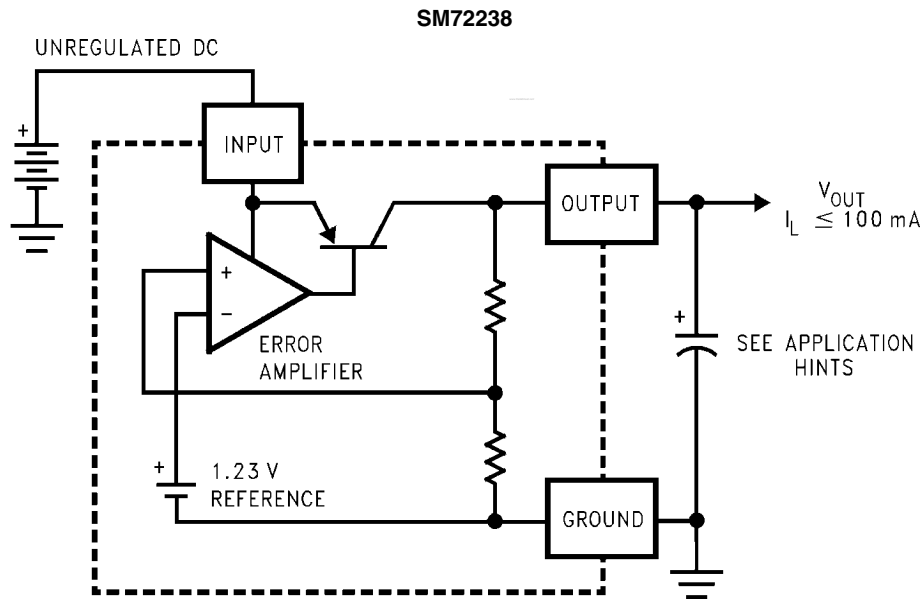

30141325

## Connection Diagrams

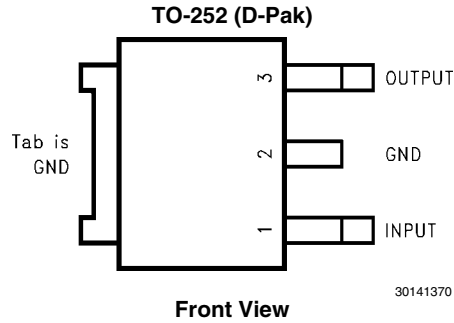

## Ordering Information

Package	Temperature Range	V <sub>OUT</sub>	Part Number	Package Marking	Transport Media	NSC Drawing
TO-252 (DPAK)	-40<T <sub>J</sub> <125	3.0	SM72238TD-3.0	S72238-3.0	75 Units in Rail	TD03B
			SM72238TDE-3.0		250 Units in Tape and Reel	
			SM72238TDX-3.0		2500 Units in Tape and Reel	
TO-252 (DPAK)	-40<T <sub>J</sub> <125	3.3	SM72238TD-3.3	S72238-3.3	75 Units in Rail	TD03B
			SM72238TDE-3.3		250 Units in Tape and Reel	
			SM72238TDX-3.3		2500 Units in Tape and Reel	
TO-252 (DPAK)	-40<T <sub>J</sub> <125	5.0	SM72238TD-5.0	S72238	75 Units in Rail	TD03B
			SM72238TDE-5.0		250 Units in Tape and Reel	
			SM72238TDX-5.0		2500 Units in Tape and Reel	

## Absolute Maximum Ratings *(Note 1)*

If Military/Aerospace specified devices are required, please contact the National Semiconductor Sales Office/Distributors for availability and specifications.

Input Supply Voltage	-0.3 to +30V
Power Dissipation	Internally Limited
Junction Temperature ( $T_J$ )	+150°C
Ambient Storage Temperature	-65° to +150°C
Soldering Dwell Time, Temperature	
Wave	4 seconds, 260°C
Infrared	10 seconds, 240°C
Vapor Phase	75 seconds, 219°C
ESD Rating	
Human Body Model <i>(Note 11)</i>	2500V

## Operating Ratings *(Note 1)*

Maximum Input Supply Voltage	30V
Junction Temperature Range ( $T_J$ ) <i>(Note 6)</i>	-40° to +125°C

## Electrical Characteristics *(Note 2)*

Parameter	Conditions <i>(Note 2)</i>	Typ	Tested Limit <i>(Note 3)</i>	Design Limit <i>(Note 4)</i>	Units
<b>3V Versions</b>					
Output Voltage	$T_J = 25^\circ\text{C}$	3.0	3.030 2.970		V max V min
	$-25^\circ\text{C} \leq T_J \leq 85^\circ\text{C}$	3.0		3.045 2.955	V max V min
	Full Operating Temperature Range	3.0		<b>3.060</b> <b>2.940</b>	V max V min
Output Voltage	$100\mu\text{A} \leq I_L \leq 100\text{mA}$	3.0		<b>3.072</b>	V max
	$T_J \leq T_{J\text{MAX}}$			<b>2.928</b>	V min
<b>3.3V Versions</b>					
Output Voltage	$T_J = 25^\circ\text{C}$	3.3	3.333 3.267		V max V min
	$-25^\circ\text{C} \leq T_J \leq 85^\circ\text{C}$	3.3		3.350 3.251	V max V min
	Full Operating Temperature Range	3.3		<b>3.366</b> <b>3.234</b>	V max V min
Output Voltage	$100\mu\text{A} \leq I_L \leq 100\text{mA}$	3.3		<b>3.379</b>	V max
	$T_J \leq T_{J\text{MAX}}$			<b>3.221</b>	V min
<b>5.0V Versions</b>					
Output Voltage	$T_J = 25^\circ\text{C}$	5.0	5.05 4.95		V max V min
	$-25^\circ\text{C} \leq T_J \leq 85^\circ\text{C}$	5.0		5.075 4.925	V max V min
	Full Operating Temperature Range	5.0		<b>5.1</b> <b>4.9</b>	V max V min
Output Voltage	$100\mu\text{A} \leq I_L \leq 100\text{mA}$	5.0		<b>5.12</b>	V max
	$T_J \leq T_{J\text{MAX}}$			<b>4.88</b>	V min
<b>All Voltage Options</b>					
Output Voltage Temperature Coefficient	<i>(Note 7)</i>	<b>50</b>		<b>150</b>	ppm/°C
Line Regulation <i>(Note 9)</i>	$(V_{O\text{NOM}} + 1)\text{V} \leq V_{\text{in}} \leq 30\text{V}$ <i>(Note 10)</i>	0.04	0.2	<b>0.4</b>	% max % max
Load Regulation <i>(Note 9)</i>	$100\mu\text{A} \leq I_L \leq 100\text{mA}$	0.1	0.2	<b>0.3</b>	% max % max

Parameter	Conditions (Note 2)	Typ	Tested Limit (Note 3)	Design Limit (Note 4)	Units
Dropout Voltage (Note 5)	$I_L = 100\mu\text{A}$	50	80	<b>150</b>	mV max mV max
	$I_L = 100\text{mA}$	380	450	<b>600</b>	mV max mV max
Ground Current	$I_L = 100\mu\text{A}$	75	120	<b>140</b>	$\mu\text{A}$ max $\mu\text{A}$ max
	$I_L = 100\text{mA}$	8	12	<b>14</b>	mA max mA max
Dropout Ground Current	$V_{in} = (V_{O,NOM} - 0.5)\text{V}$ $I_L = 100\mu\text{A}$	110	170	<b>200</b>	$\mu\text{A}$ max $\mu\text{A}$ max
Current Limit	$V_{out} = 0$	160	200	<b>220</b>	mA max mA max
Thermal Regulation	(Note 8)	0.05	0.2		%/W max
Output Noise, 10 Hz to 100 kHz	$C_L = 1\mu\text{F}$ (5V Only)	430			$\mu\text{V}$ rms
	$C_L = 200\mu\text{F}$	160			$\mu\text{V}$ rms
	$C_L = 3.3\mu\text{F}$ (Bypass = $0.01\mu\text{F}$ )	100			$\mu\text{V}$ rms

**Note 1:** Absolute Maximum Ratings are limits beyond which damage to the device may occur. Operating Ratings are conditions under which operation of the device is guaranteed. Operating Ratings do not imply guaranteed performance limits. For guaranteed performance limits and associated test conditions, see the Electrical Characteristics tables.

**Note 2:** Unless otherwise specified all limits guaranteed for  $V_{IN} = (V_{ONOM} + 1)\text{V}$ ,  $I_L = 100\mu\text{A}$  and  $C_L = 1\mu\text{F}$ . Limits appearing in **boldface** type apply over the entire junction temperature range for operation. Limits appearing in normal type apply for  $T_A = T_J = 25^\circ\text{C}$ .

**Note 3:** Guaranteed and 100% production tested.

**Note 4:** Guaranteed but not 100% production tested. These limits are not used to calculate outgoing AQL levels.

**Note 5:** Dropout Voltage is defined as the input to output differential at which the output voltage drops 100 mV below its nominal value measured at 1V differential. At very low values of programmed output voltage, the minimum input supply voltage of 2V (2.3V over temperature) must be taken into account.

**Note 6:** Junction-to-case thermal resistance for the TO-252 package is  $5.4^\circ\text{C/W}$ .

**Note 7:** Output or reference voltage temperature coefficient is defined as the worst case voltage change divided by the total temperature range.

**Note 8:** Thermal regulation is defined as the change in output voltage at a time T after a change in power dissipation is applied, excluding load or line regulation effects. Specifications are for a 50mA load pulse at  $V_{IN} = 30\text{V}$  (1.25W pulse) for  $T = 10\text{ms}$ .

**Note 9:** Regulation is measured at constant junction temperature, using pulse testing with a low duty cycle. Changes in output voltage due to heating effects are covered under the specification for thermal regulation.

**Note 10:** For  $I_L = 100\mu\text{A}$  and  $T_J = 125^\circ\text{C}$ , line regulation is guaranteed by design to 0.2%. See Typical Performance Characteristics for line regulation versus temperature and load current.

**Note 11:** Human Body Model 1.5k $\Omega$  in series with 100pF.

# Typical Performance Characteristics

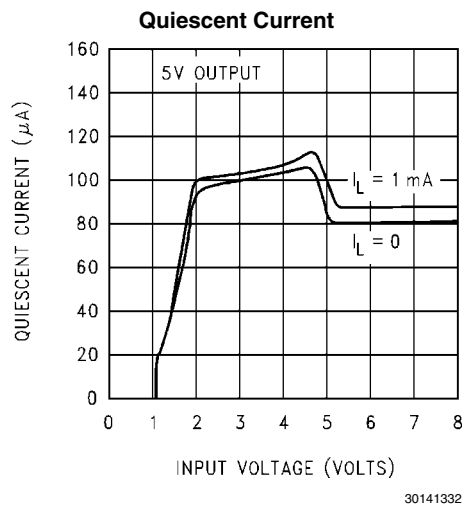
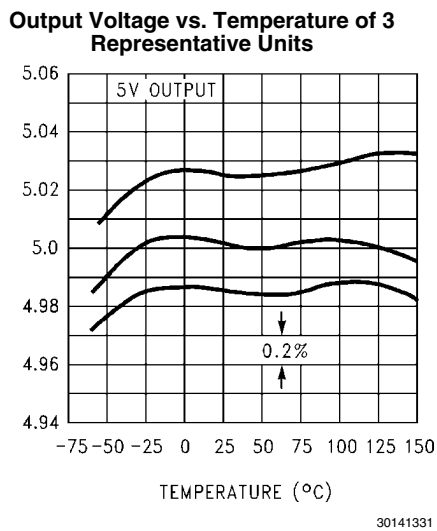
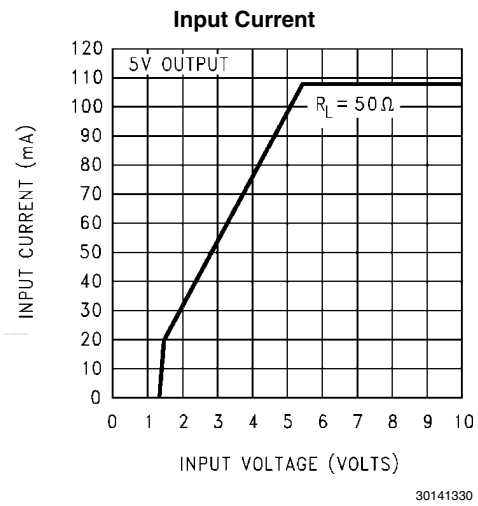
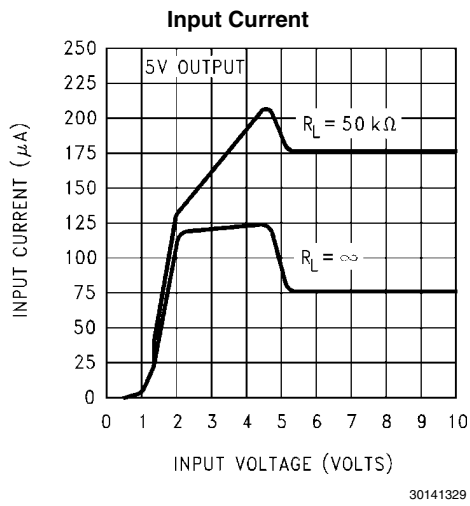
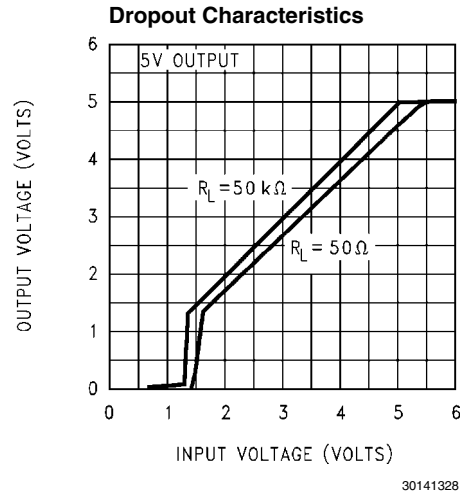
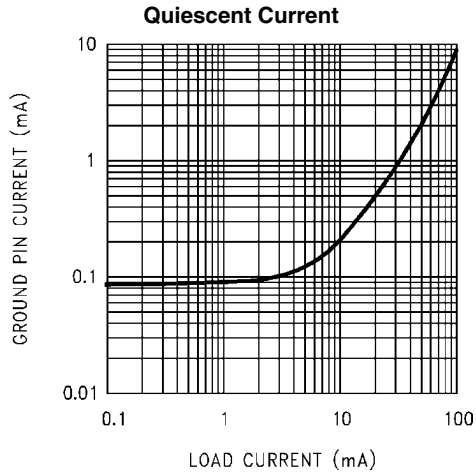

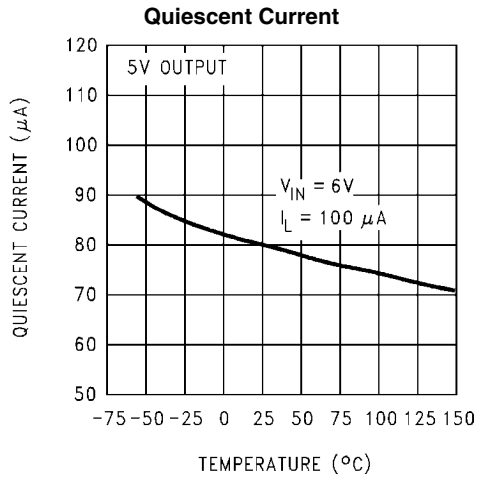

30141333

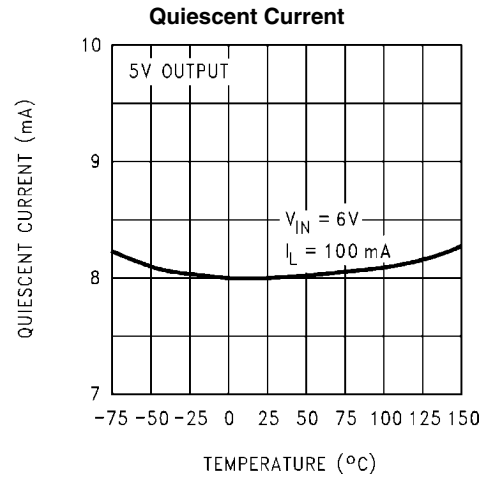

30141334

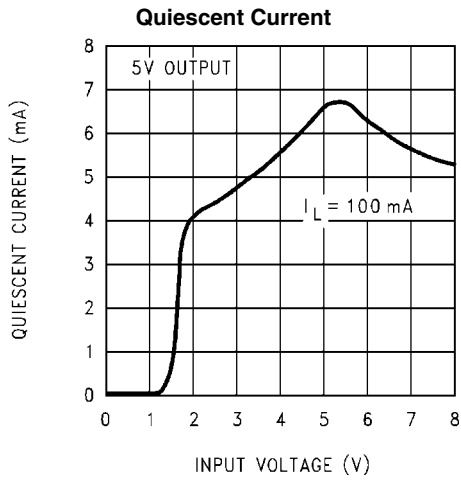

30141335

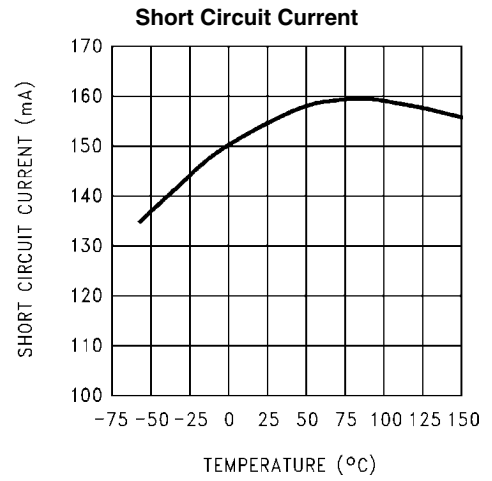

30141336

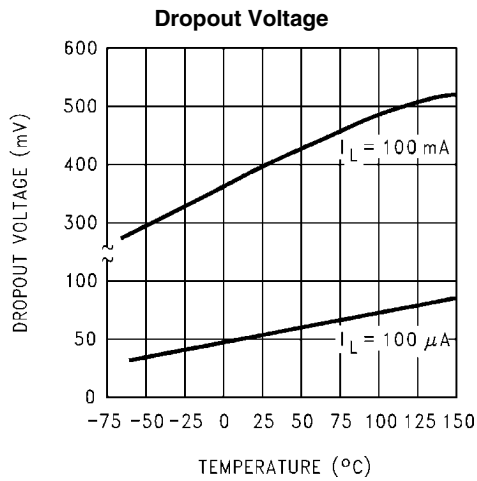

30141337

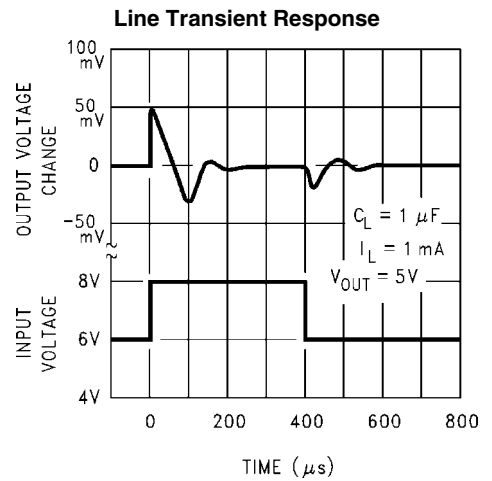

30141344

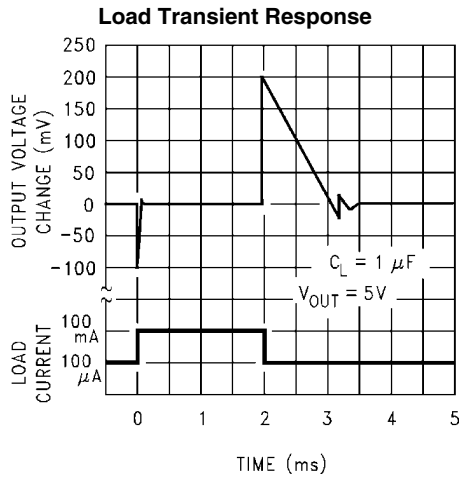

30141345

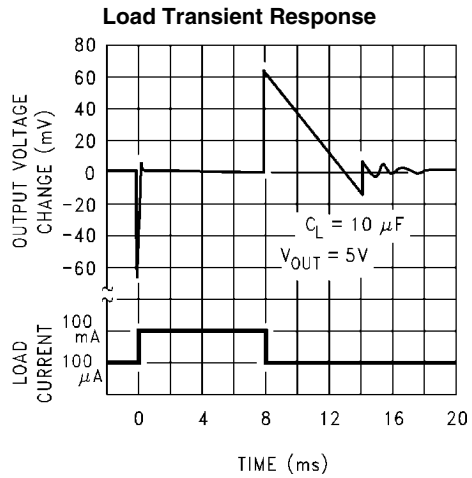

30141346

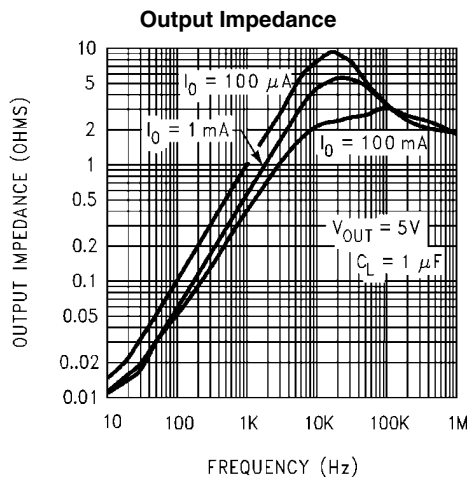

30141348

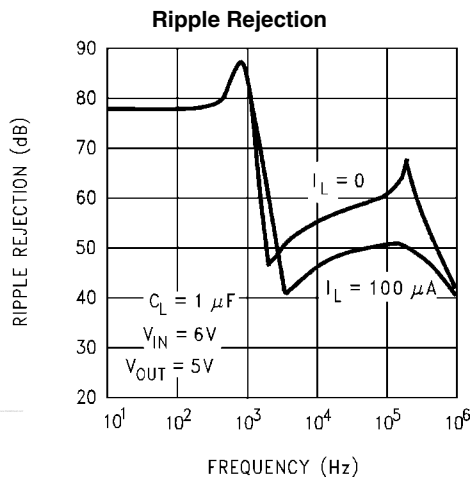

30141349

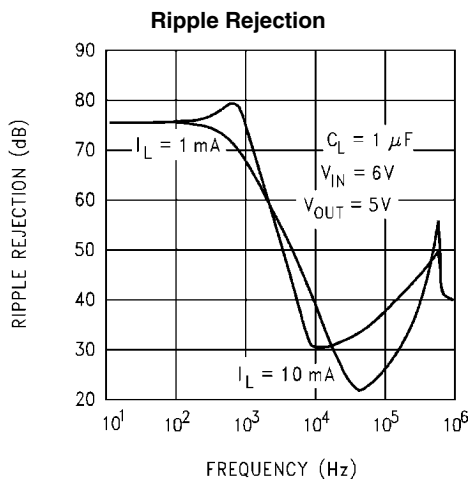

30141350

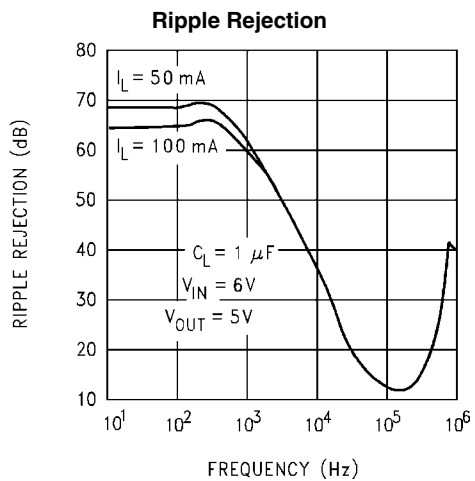

30141351

**Shutdown Threshold Voltage**

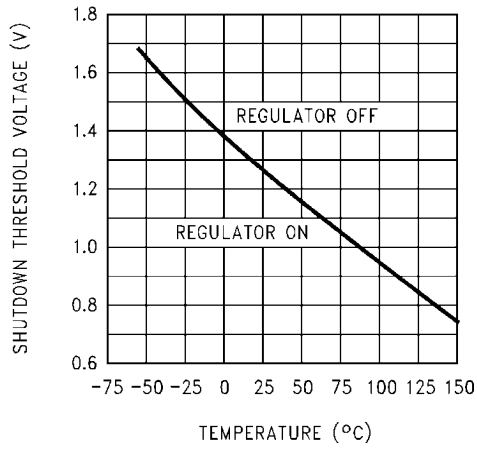

30141354

**Line Regulation**

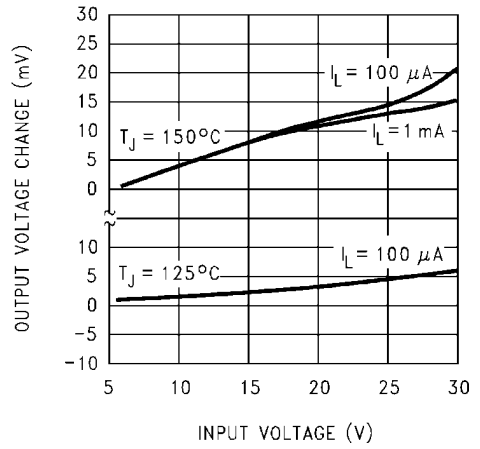

30141355

**Maximum Rated Output Current**

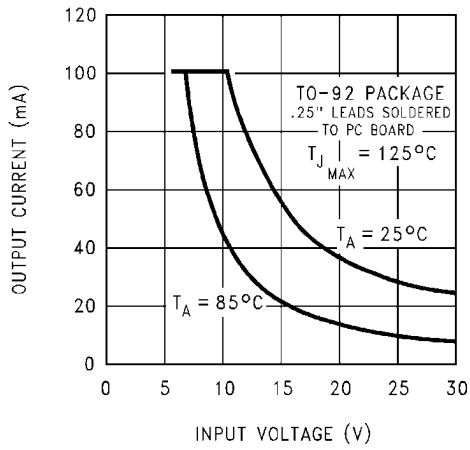

30141357

**Thermal Response**

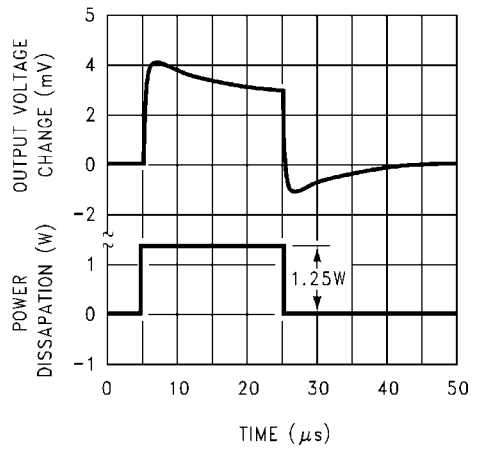

30141358

**Output Capacitor ESR Range**

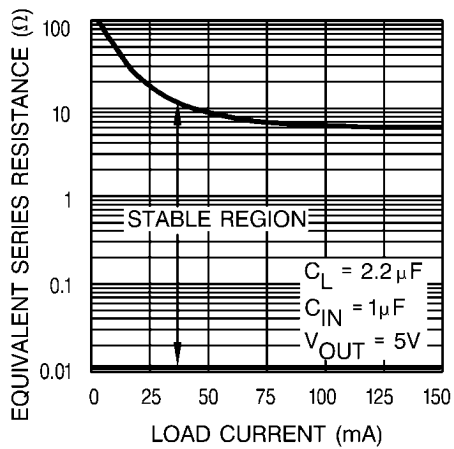

30141363



## Application Hints

### EXTERNAL CAPACITORS

A 1.0 $\mu$ F (or greater) capacitor is required between the output and ground for stability. Without this capacitor the part will oscillate. Most types of tantalum or aluminum electrolytics work fine here; even film types work but are not recommended for reasons of cost. Many aluminum electrolytics have electrolytes that freeze at about  $-30^{\circ}\text{C}$ , so solid tantalums are recommended for operation below  $-25^{\circ}\text{C}$ . The important parameters of the capacitor are an ESR of about  $5\Omega$  or less and a resonant frequency above 500kHz. The value of this capacitor may be increased without limit.

Ceramic capacitors whose value is greater than 1000pF should not be connected directly from the SM72238 output to ground. Ceramic capacitors typically have ESR values in the range of 5 to 10m $\Omega$ , a value below the lower limit for stable operation (see curve Output Capacitor ESR Range).

The reason for the lower ESR limit is that the loop compensation of the part relies on the ESR of the output capacitor to provide the zero that gives added phase lead. The ESR of ceramic capacitors is so low that this phase lead does not occur, significantly reducing phase margin. A ceramic output

capacitor can be used if a series resistance is added (recommended value of resistance about 0.1 $\Omega$  to 2 $\Omega$ ).

At lower values of output current, less output capacitance is required for stability. The capacitor can be reduced to 0.33 $\mu$ F for currents below 10mA or 0.1 $\mu$ F for currents below 1mA.

Unlike many other regulators, the SM72238 will remain stable and in regulation with no load in addition to the internal voltage divider. This is especially important in CMOS RAM keep-alive applications.

A 1 $\mu$ F tantalum, ceramic or aluminum electrolytic capacitor should be placed from the SM72238 input to ground if there is more than 10 inches of wire between the input and the AC filter capacitor or if a battery is used as the input.

### REDUCING OUTPUT NOISE

In reference applications it may be advantageous to reduce the AC noise present at the output. One method is to reduce the regulator bandwidth by increasing the size of the output capacitor. This is the only way noise can be reduced but is relatively inefficient, as increasing the capacitor from 1 $\mu$ F to 220 $\mu$ F only decreases the noise from 430 $\mu$ V to 160 $\mu$ V rms for a 100kHz bandwidth at 5V output.

## Typical Applications

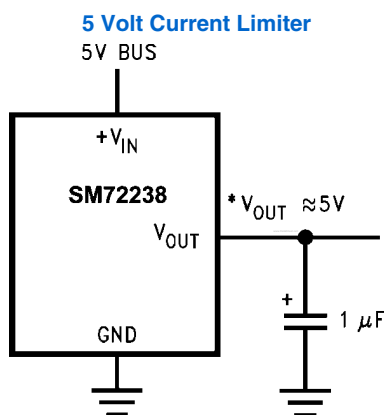

30141310

\*Minimum input-output voltage ranges from 40mV to 400mV, depending on load current. Current limit is typically 160mA.

# Schematic Diagram

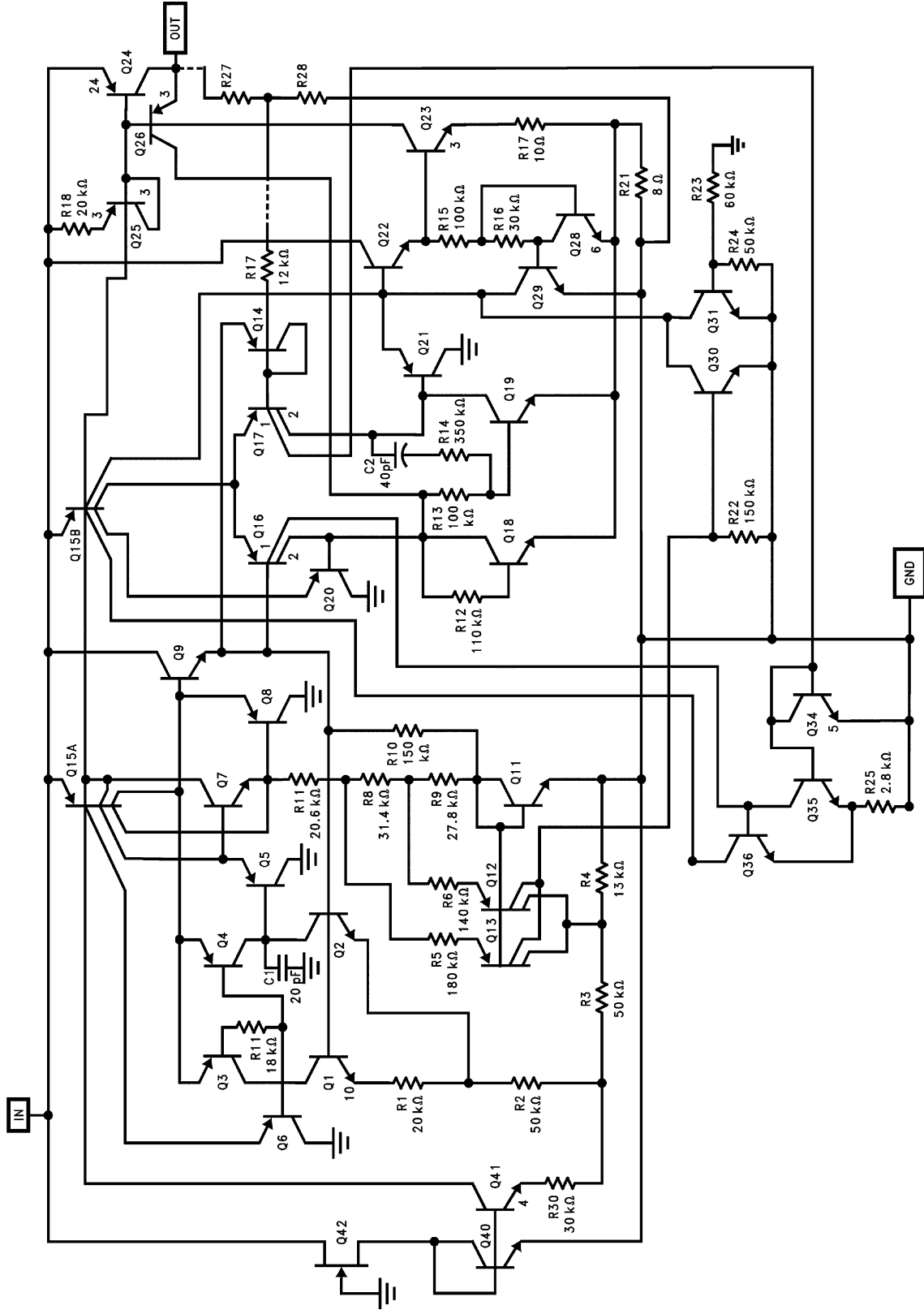

**Physical Dimensions** inches (millimeters) unless otherwise noted

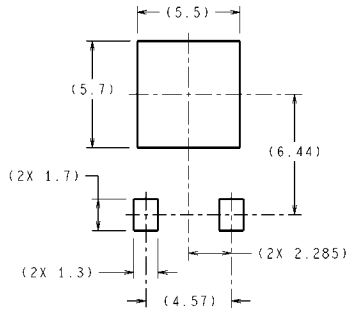

DIMENSIONS ARE IN MILLIMETERS

**LAND PATTERN RECOMMENDATION**

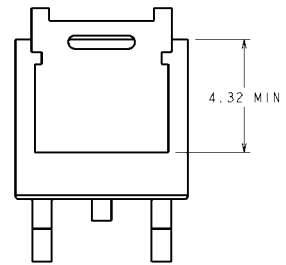
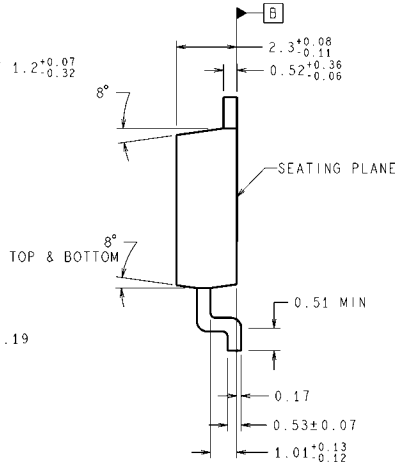
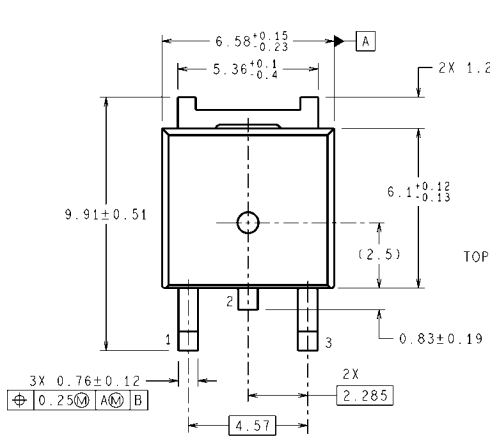

**D-Pak Package**  
**NS Package Number TD03B**

TD03B (Rev E)

## Notes

For more National Semiconductor product information and proven design tools, visit the following Web sites at:  
[www.national.com](http://www.national.com)

Products		Design Support	
Amplifiers	<a href="http://www.national.com/amplifiers">www.national.com/amplifiers</a>	WEBENCH® Tools	<a href="http://www.national.com/webench">www.national.com/webench</a>
Audio	<a href="http://www.national.com/audio">www.national.com/audio</a>	App Notes	<a href="http://www.national.com/appnotes">www.national.com/appnotes</a>
Clock and Timing	<a href="http://www.national.com/timing">www.national.com/timing</a>	Reference Designs	<a href="http://www.national.com/refdesigns">www.national.com/refdesigns</a>
Data Converters	<a href="http://www.national.com/adc">www.national.com/adc</a>	Samples	<a href="http://www.national.com/samples">www.national.com/samples</a>
Interface	<a href="http://www.national.com/interface">www.national.com/interface</a>	Eval Boards	<a href="http://www.national.com/evalboards">www.national.com/evalboards</a>
LVDS	<a href="http://www.national.com/lvds">www.national.com/lvds</a>	Packaging	<a href="http://www.national.com/packaging">www.national.com/packaging</a>
Power Management	<a href="http://www.national.com/power">www.national.com/power</a>	Green Compliance	<a href="http://www.national.com/quality/green">www.national.com/quality/green</a>
Switching Regulators	<a href="http://www.national.com/switchers">www.national.com/switchers</a>	Distributors	<a href="http://www.national.com/contacts">www.national.com/contacts</a>
LDOs	<a href="http://www.national.com/ldo">www.national.com/ldo</a>	Quality and Reliability	<a href="http://www.national.com/quality">www.national.com/quality</a>
LED Lighting	<a href="http://www.national.com/led">www.national.com/led</a>	Feedback/Support	<a href="http://www.national.com/feedback">www.national.com/feedback</a>
Voltage References	<a href="http://www.national.com/vref">www.national.com/vref</a>	Design Made Easy	<a href="http://www.national.com/easy">www.national.com/easy</a>
PowerWise® Solutions	<a href="http://www.national.com/powerwise">www.national.com/powerwise</a>	Applications & Markets	<a href="http://www.national.com/solutions">www.national.com/solutions</a>
Serial Digital Interface (SDI)	<a href="http://www.national.com/sdi">www.national.com/sdi</a>	Mil/Aero	<a href="http://www.national.com/milaero">www.national.com/milaero</a>
Temperature Sensors	<a href="http://www.national.com/tempensors">www.national.com/tempensors</a>	SolarMagic™	<a href="http://www.national.com/solarmagic">www.national.com/solarmagic</a>
PLL/VCO	<a href="http://www.national.com/wireless">www.national.com/wireless</a>	PowerWise® Design University	<a href="http://www.national.com/training">www.national.com/training</a>

THE CONTENTS OF THIS DOCUMENT ARE PROVIDED IN CONNECTION WITH NATIONAL SEMICONDUCTOR CORPORATION ("NATIONAL") PRODUCTS. NATIONAL MAKES NO REPRESENTATIONS OR WARRANTIES WITH RESPECT TO THE ACCURACY OR COMPLETENESS OF THE CONTENTS OF THIS PUBLICATION AND RESERVES THE RIGHT TO MAKE CHANGES TO SPECIFICATIONS AND PRODUCT DESCRIPTIONS AT ANY TIME WITHOUT NOTICE. NO LICENSE, WHETHER EXPRESS, IMPLIED, ARISING BY ESTOPPEL OR OTHERWISE, TO ANY INTELLECTUAL PROPERTY RIGHTS IS GRANTED BY THIS DOCUMENT.

TESTING AND OTHER QUALITY CONTROLS ARE USED TO THE EXTENT NATIONAL DEEMS NECESSARY TO SUPPORT NATIONAL'S PRODUCT WARRANTY. EXCEPT WHERE MANDATED BY GOVERNMENT REQUIREMENTS, TESTING OF ALL PARAMETERS OF EACH PRODUCT IS NOT NECESSARILY PERFORMED. NATIONAL ASSUMES NO LIABILITY FOR APPLICATIONS ASSISTANCE OR BUYER PRODUCT DESIGN. BUYERS ARE RESPONSIBLE FOR THEIR PRODUCTS AND APPLICATIONS USING NATIONAL COMPONENTS. PRIOR TO USING OR DISTRIBUTING ANY PRODUCTS THAT INCLUDE NATIONAL COMPONENTS, BUYERS SHOULD PROVIDE ADEQUATE DESIGN, TESTING AND OPERATING SAFEGUARDS.

EXCEPT AS PROVIDED IN NATIONAL'S TERMS AND CONDITIONS OF SALE FOR SUCH PRODUCTS, NATIONAL ASSUMES NO LIABILITY WHATSOEVER, AND NATIONAL DISCLAIMS ANY EXPRESS OR IMPLIED WARRANTY RELATING TO THE SALE AND/OR USE OF NATIONAL PRODUCTS INCLUDING LIABILITY OR WARRANTIES RELATING TO FITNESS FOR A PARTICULAR PURPOSE, MERCHANTABILITY, OR INFRINGEMENT OF ANY PATENT, COPYRIGHT OR OTHER INTELLECTUAL PROPERTY RIGHT.

#### LIFE SUPPORT POLICY

**NATIONAL'S PRODUCTS ARE NOT AUTHORIZED FOR USE AS CRITICAL COMPONENTS IN LIFE SUPPORT DEVICES OR SYSTEMS WITHOUT THE EXPRESS PRIOR WRITTEN APPROVAL OF THE CHIEF EXECUTIVE OFFICER AND GENERAL COUNSEL OF NATIONAL SEMICONDUCTOR CORPORATION.** As used herein:

Life support devices or systems are devices which (a) are intended for surgical implant into the body, or (b) support or sustain life and whose failure to perform when properly used in accordance with instructions for use provided in the labeling can be reasonably expected to result in a significant injury to the user. A critical component is any component in a life support device or system whose failure to perform can be reasonably expected to cause the failure of the life support device or system or to affect its safety or effectiveness.

National Semiconductor and the National Semiconductor logo are registered trademarks of National Semiconductor Corporation. All other brand or product names may be trademarks or registered trademarks of their respective holders.

Copyright© 2011 National Semiconductor Corporation

For the most current product information visit us at [www.national.com](http://www.national.com)



**National Semiconductor  
Americas Technical  
Support Center**  
Email: [support@nsc.com](mailto:support@nsc.com)  
Tel: 1-800-272-9959

**National Semiconductor Europe  
Technical Support Center**  
Email: [europe.support@nsc.com](mailto:europe.support@nsc.com)

**National Semiconductor Asia  
Pacific Technical Support Center**  
Email: [ap.support@nsc.com](mailto:ap.support@nsc.com)

**National Semiconductor Japan  
Technical Support Center**  
Email: [jpn.feedback@nsc.com](mailto:jpn.feedback@nsc.com)