

SM72501

SM72501 SolarMagic Precision, CMOS Input, RRIO, Wide Supply Range Amplifier



Literature Number: SNIS157B

SM72501

SolarMagic Precision, CMOS Input, RRIO, Wide Supply Range Amplifier

General Description

The SM72501 is a low offset voltage, rail-to-rail input and output precision amplifier with a CMOS input stage and a wide supply voltage range. The SM72501 is ideal for sensor interface and other instrumentation applications.

The guaranteed low offset voltage of less than $\pm 200 \mu\text{V}$ along with the guaranteed low input bias current of less than $\pm 1 \text{ pA}$ makes the SM72501 ideal for precision applications. The SM72501 is built utilizing VIP50 technology, which allows the combination of a CMOS input stage and a 12V common mode and supply voltage range. This makes the SM72501 a great choice in many applications where conventional CMOS parts cannot operate under the desired voltage conditions.

The SM72501 has a rail-to-rail input stage that significantly reduces the CMRR glitch commonly associated with rail-to-rail input amplifiers. This is achieved by trimming both sides of the complimentary input stage, thereby reducing the difference between the NMOS and PMOS offsets. The output of the SM72501 swings within 40 mV of either rail to maximize the signal dynamic range in applications requiring low supply voltage.

The SM72501 is offered in the space saving 5-Pin SOT23. This small package is an ideal solution for area constrained PC boards and portable electronics.

Features

- Renewable Energy Grade

Unless otherwise noted, typical values at $V_S = 5\text{V}$

- | | |
|---------------------------------|--|
| ■ Input offset voltage | $\pm 200 \mu\text{V}$ (max) |
| ■ Input bias current | $\pm 200 \text{ fA}$ |
| ■ Input voltage noise | 9 nV/ $\sqrt{\text{Hz}}$ |
| ■ CMRR | 130 dB |
| ■ Open loop gain | 130 dB |
| ■ Temperature range | -40°C to 125°C |
| ■ Unity gain bandwidth | 2.5 MHz |
| ■ Supply current (SM72501) | 715 μA |
| ■ Supply voltage range | 2.7V to 12V |
| ■ Rail-to-rail input and output | |

Applications

- High impedance sensor interface
- Battery powered instrumentation
- High gain amplifiers
- DAC buffer
- Instrumentation amplifier
- Active filters



Typical Application

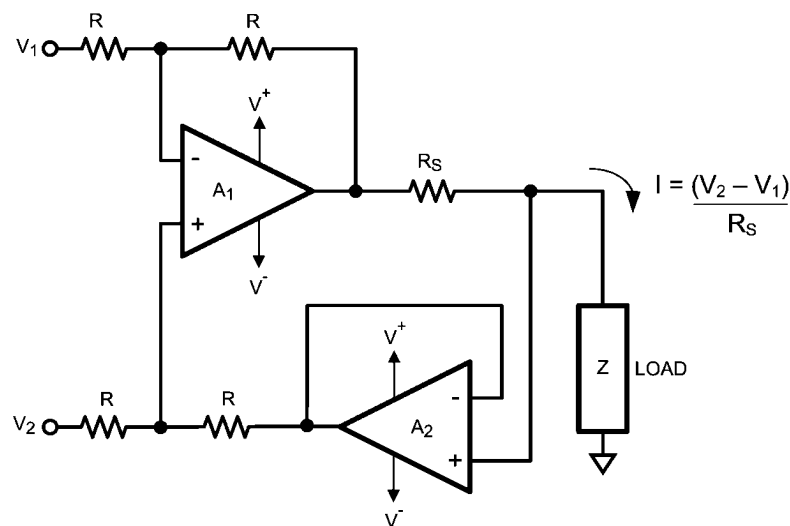

Precision Current Source

30142105

Absolute Maximum Ratings (Note 1)

If Military/Aerospace specified devices are required, please contact the National Semiconductor Sales Office/ Distributors for availability and specifications.

ESD Tolerance (Note 2)

| | |
|--------------------------------------|---------------------------|
| Human Body Model | 2000V |
| Machine Model | 200V |
| Charge-Device Model | 1000V |
| V_{IN} Differential | ± 300 mV |
| Supply Voltage ($V_S = V^+ - V^-$) | 13.2V |
| Voltage at Input/Output Pins | $V^{++} 0.3V, V^- - 0.3V$ |
| Input Current | 10 mA |

| | |
|------------------------------------|---|
| Storage Temperature Range | -65°C to $+150^\circ\text{C}$ |
| Junction Temperature (Note 3) | $+150^\circ\text{C}$ |
| Soldering Information | |
| Infrared or Convection (20 sec) | 235°C |
| Wave Soldering Lead Temp. (10 sec) | 260°C |

Operating Ratings (Note 1)

| | |
|--|---|
| Temperature Range (Note 3) | -40°C to $+125^\circ\text{C}$ |
| Supply Voltage ($V_S = V^+ - V^-$) | 2.7V to 12V |
| Package Thermal Resistance (θ_{JA} (Note 3)) | |
| 5-Pin SOT23 | 265°C/W |

3V Electrical Characteristics (Note 4)

Unless otherwise specified, all limits are guaranteed for $T_A = 25^\circ\text{C}$, $V^+ = 3V$, $V^- = 0V$, $V_{CM} = V^+/2$, and $R_L > 10\text{ k}\Omega$ to $V^+/2$. **Boldface** limits apply at the temperature extremes.

| Symbol | Parameter | Conditions | Min (Note 6) | Typ (Note 5) | Max (Note 6) | Units |
|------------|--|---|--------------------------------------|-----------------|---|------------------------------|
| V_{OS} | Input Offset Voltage | | | ± 37 | ± 200 ± 500 | μV |
| TCV_{OS} | Input Offset Voltage Temperature Drift | (Note 7) | | ± 1 | ± 5 | $\mu\text{V}/^\circ\text{C}$ |
| I_B | Input Bias Current | (Note 7, Note 8) $-40^\circ\text{C} \leq T_A \leq 85^\circ\text{C}$ (Note 7, Note 8) $-40^\circ\text{C} \leq T_A \leq 125^\circ\text{C}$ | | ± 0.2 | ± 1 ± 50 ± 1 ± 400 | pA |
| I_{OS} | Input Offset Current | | | 40 | | fA |
| CMRR | Common Mode Rejection Ratio | $0V \leq V_{CM} \leq 3V$ | 86 80 | 130 | | dB |
| PSRR | Power Supply Rejection Ratio | $2.7V \leq V^+ \leq 12V, V_O = V^+/2$ | 86 82 | 98 | | dB |
| CMVR | Common Mode Voltage Range | CMRR ≥ 80 dB CMRR ≥ 77 dB | -0.2 -0.2 | | 3.2 3.2 | V |
| A_{VOL} | Open Loop Voltage Gain | $R_L = 2\text{ k}\Omega$ $V_O = 0.3V$ to $2.7V$ $R_L = 10\text{ k}\Omega$ $V_O = 0.2V$ to $2.8V$ | 100 96 100 96 | 114 124 | | dB |
| V_{OUT} | Output Voltage Swing High | $R_L = 2\text{ k}\Omega$ to $V^+/2$ $R_L = 10\text{ k}\Omega$ to $V^+/2$ | | 40 30 | 80 120 40 60 | mV from V^+ |
| | Output Voltage Swing Low | $R_L = 2\text{ k}\Omega$ to $V^+/2$ $R_L = 10\text{ k}\Omega$ to $V^+/2$ | | 40 20 | 60 80 40 50 | mV |
| I_{OUT} | Output Current (Note 3, Note 9) | Sourcing $V_O = V^+/2$ $V_{IN} = 100\text{ mV}$ Sinking $V_O = V^+/2$ $V_{IN} = -100\text{ mV}$ | 25 15 25 20 | 42 42 | | mA |
| I_S | Supply Current | | | 0.670 | 1.0 1.2 | mA |
| SR | Slew Rate (Note 10) | $A_V = +1, V_O = 2 V_{PP}$ 10% to 90% | | 0.9 | | V/ μs |

| Symbol | Parameter | Conditions | Min (Note 6) | Typ (Note 5) | Max (Note 6) | Units |
|--------|--------------------------------------|--|-----------------|-----------------|-----------------|------------------------------|
| GBW | Gain Bandwidth | | | 2.5 | | MHz |
| THD+N | Total Harmonic Distortion + Noise | $f = 1 \text{ kHz}$, $A_V = 1$, $R_L = 10 \text{ k}\Omega$ | | 0.02 | | % |
| e_n | Input Referred Voltage Noise Density | $f = 1 \text{ kHz}$ | | 9 | | $\text{nV}/\sqrt{\text{Hz}}$ |
| i_n | Input Referred Current Noise Density | $f = 100 \text{ kHz}$ | | 1 | | $\text{fA}/\sqrt{\text{Hz}}$ |

5V Electrical Characteristics (Note 4)

Unless otherwise specified, all limits are guaranteed for $T_A = 25^\circ\text{C}$, $V^+ = 5\text{V}$, $V^- = 0\text{V}$, $V_{\text{CM}} = V^+/2$, and $R_L > 10 \text{ k}\Omega$ to $V^+/2$.

Boldface limits apply at the temperature extremes.

| Symbol | Parameter | Conditions | Min (Note 6) | Typ (Note 5) | Max (Note 6) | Units | |
|--------------------------|--|---|------------------------------------|-----------------|--|------------------------------|----|
| V_{OS} | Input Offset Voltage | | | ± 37 | ± 200 ± 500 | μV | |
| TCV_{OS} | Input Offset Voltage Temperature Drift | (Note 7) | | ± 1 | ± 5 | $\mu\text{V}/^\circ\text{C}$ | |
| I_B | Input Bias Current | (Note 7, Note 8) $-40^\circ\text{C} \leq T_A \leq 85^\circ\text{C}$ | | ± 0.2 | ± 1 ± 50 | pA | |
| | | (Note 7, Note 8) $-40^\circ\text{C} \leq T_A \leq 125^\circ\text{C}$ | | ± 0.2 | ± 1 ± 400 | | |
| I_{OS} | Input Offset Current | | | 40 | | fA | |
| CMRR | Common Mode Rejection Ratio | $0\text{V} \leq V_{\text{CM}} \leq 5\text{V}$ | 88 83 | 130 | | dB | |
| PSRR | Power Supply Rejection Ratio | $2.7\text{V} \leq V^+ \leq 12\text{V}$, $V_O = V^+/2$ | 86 82 | 100 | | dB | |
| CMVR | Common Mode Voltage Range | CMRR $\geq 80 \text{ dB}$ CMRR $\geq 78 \text{ dB}$ | -0.2 -0.2 | | 5.2 5.2 | V | |
| A_{VOL} | Open Loop Voltage Gain | $R_L = 2 \text{ k}\Omega$ $V_O = 0.3\text{V to } 4.7\text{V}$ | 100 96 | 119 | | dB | |
| | | $R_L = 10 \text{ k}\Omega$ $V_O = 0.2\text{V to } 4.8\text{V}$ | 100 96 | 130 | | | |
| V_{OUT} | Output Voltage Swing High | $R_L = 2 \text{ k}\Omega$ to $V^+/2$ | | 60 | 110 130 | mV from V^+ | |
| | | $R_L = 10 \text{ k}\Omega$ to $V^+/2$ | | 40 | 50 70 | | |
| | Output Voltage Swing Low | $R_L = 2 \text{ k}\Omega$ to $V^+/2$ | | | 50 | 80 90 | mV |
| | | $R_L = 10 \text{ k}\Omega$ to $V^+/2$ | | | 30 | 40 50 | |
| I_{OUT} | Output Current (Note 3, Note 9) | Sourcing $V_O = V^+/2$ $V_{\text{IN}} = 100 \text{ mV}$ | 40 28 | 66 | | mA | |
| | | Sinking $V_O = V^+/2$ $V_{\text{IN}} = -100 \text{ mV}$ | 40 28 | 76 | | | |
| I_S | Supply Current | | | 0.715 | 1.0 1.2 | mA | |
| SR | Slew Rate (Note 10) | $A_V = +1$, $V_O = 4 V_{\text{PP}}$ 10% to 90% | | 1.0 | | $\text{V}/\mu\text{s}$ | |
| GBW | Gain Bandwidth | | | 2.5 | | MHz | |
| THD+N | Total Harmonic Distortion + Noise | $f = 1 \text{ kHz}$, $A_V = 1$, $R_L = 10 \text{ k}\Omega$ | | 0.02 | | % | |

| Symbol | Parameter | Conditions | Min (Note 6) | Typ (Note 5) | Max (Note 6) | Units |
|--------|--------------------------------------|-----------------------|-----------------|-----------------|-----------------|------------------------------|
| e_n | Input Referred Voltage Noise Density | $f = 1 \text{ kHz}$ | | 9 | | $\text{nV}/\sqrt{\text{Hz}}$ |
| i_n | Input Referred Current Noise Density | $f = 100 \text{ kHz}$ | | 1 | | $\text{fA}/\sqrt{\text{Hz}}$ |

±5V Electrical Characteristics (Note 4)

Unless otherwise specified, all limits are guaranteed for $T_A = 25^\circ\text{C}$, $V^+ = 5\text{V}$, $V^- = -5\text{V}$, $V_{\text{CM}} = 0\text{V}$, and $R_L > 10 \text{ k}\Omega$ to 0V . **Bold-face** limits apply at the temperature extremes.

| Symbol | Parameter | Conditions | Min (Note 6) | Typ (Note 5) | Max (Note 6) | Units |
|--------------------------|--|---|------------------|-----------------|---------------------|------------------------------|
| V_{OS} | Input Offset Voltage | | | ±37 | ±200 ±500 | μV |
| TCV_{OS} | Input Offset Voltage Temperature Drift | (Note 7) | | ±1 | ±5 | $\mu\text{V}/^\circ\text{C}$ |
| I_B | Input Bias Current | (Note 7, Note 8) $-40^\circ\text{C} \leq T_A \leq 85^\circ\text{C}$ | | ±0.2 | 1 ±50 | pA |
| | | (Note 7, Note 8) $-40^\circ\text{C} \leq T_A \leq 125^\circ\text{C}$ | | ±0.2 | 1 ±400 | |
| I_{OS} | Input Offset Current | | | 40 | | fA |
| CMRR | Common Mode Rejection Ratio | $-5\text{V} \leq V_{\text{CM}} \leq 5\text{V}$ | 92 88 | 138 | | dB |
| PSRR | Power Supply Rejection Ratio | $2.7\text{V} \leq V^+ \leq 12\text{V}$, $V_O = 0\text{V}$ | 86 82 | 98 | | dB |
| CMVR | Common Mode Voltage Range | CMRR ≥ 80 dB | -5.2 | | 5.2 | V |
| | | CMRR ≥ 78 dB | -5.2 | | 5.2 | |
| A_{VOL} | Open Loop Voltage Gain | $R_L = 2 \text{ k}\Omega$ $V_O = -4.7\text{V}$ to 4.7V | 100 98 | 121 | | dB |
| | | $R_L = 10 \text{ k}\Omega$ $V_O = -4.8\text{V}$ to 4.8V | 100 98 | 134 | | |
| V_{OUT} | Output Voltage Swing High | $R_L = 2 \text{ k}\Omega$ to 0V | | 90 | 150 170 | mV from V^+ |
| | | $R_L = 10 \text{ k}\Omega$ to 0V | | 40 | 80 100 | |
| | Output Voltage Swing Low | $R_L = 2 \text{ k}\Omega$ to 0V | | 90 | 130 150 | mV from V^- |
| | | $R_L = 10 \text{ k}\Omega$ to 0V | | 40 | 50 60 | |
| I_{OUT} | Output Current (Note 3, Note 9) | Sourcing $V_O = 0\text{V}$ $V_{\text{IN}} = 100 \text{ mV}$ | 50 35 | 86 | | mA |
| | | Sinking $V_O = 0\text{V}$ $V_{\text{IN}} = -100 \text{ mV}$ | 50 35 | 84 | | |
| I_S | Supply Current | | | 0.790 | 1.1 1.3 | mA |
| SR | Slew Rate (Note 10) | $A_V = +1$, $V_O = 9 V_{\text{PP}}$ 10% to 90% | | 1.1 | | $\text{V}/\mu\text{s}$ |
| GBW | Gain Bandwidth | | | 2.5 | | MHz |
| THD+N | Total Harmonic Distortion + Noise | $f = 1 \text{ kHz}$, $A_V = 1$, $R_L = 10 \text{ k}\Omega$ | | 0.02 | | % |
| e_n | Input Referred Voltage Noise Density | $f = 1 \text{ kHz}$ | | 9 | | $\text{nV}/\sqrt{\text{Hz}}$ |
| i_n | Input Referred Current Noise Density | $f = 100 \text{ kHz}$ | | 1 | | $\text{fA}/\sqrt{\text{Hz}}$ |

Note 1: Absolute Maximum Ratings indicate limits beyond which damage to the device may occur. Operating Ratings indicate conditions for which the device is intended to be functional, but specific performance is not guaranteed. For guaranteed specifications and the test conditions, see the Electrical Characteristics Tables.

Note 2: Human Body Model, applicable std. MIL-STD-883, Method 3015.7. Machine Model, applicable std. JESD22-A115-A (ESD MM std. of JEDEC) Field-Induced Charge-Device Model, applicable std. JESD22-C101-C (ESD FICDM std. of JEDEC).

Note 3: The maximum power dissipation is a function of $T_{J(MAX)}$, θ_{JA} . The maximum allowable power dissipation at any ambient temperature is $P_D = (T_{J(MAX)} - T_A) / \theta_{JA}$. All numbers apply for packages soldered directly onto a PC Board.

Note 4: Electrical Table values apply only for factory testing conditions at the temperature indicated. Factory testing conditions result in very limited self-heating of the device such that $T_J = T_A$. No guarantee of parametric performance is indicated in the electrical tables under conditions of internal self-heating where $T_J > T_A$.

Note 5: Typical values represent the most likely parametric norm as determined at the time of characterization. Actual typical values may vary over time and will also depend on the application and configuration. The typical values are not tested and are not guaranteed on shipped production material.

Note 6: Limits are 100% production tested at 25°C. Limits over the operating temperature range are guaranteed through correlations using the Statistical Quality Control (SQC) method.

Note 7: This parameter is guaranteed by design and/or characterization and is not tested in production.

Note 8: Positive current corresponds to current flowing into the device.

Note 9: The short circuit test is a momentary test.

Note 10: The number specified is the slower of positive and negative slew rates.

Connection Diagram

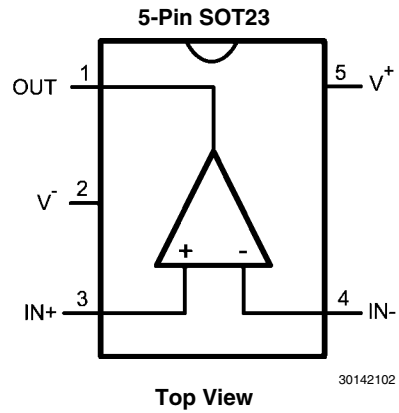

Ordering Information

| Package | Part Number | Package Marking | Transport Media | NSC Drawing |
|-------------|-------------|-----------------|--------------------------|-------------|
| 5-Pin SOT23 | SM72501MFE | S501 | 250 Units Tape and Reel | MF05A |
| 5-Pin SOT23 | SM72501MF | S501 | 1000 Units Tape and Reel | MF05A |
| 5-Pin SOT23 | SM72501MFX | S501 | 3000 Units Tape and Reel | MF05A |

Typical Performance Characteristics

Unless otherwise noted: $T_A = 25^\circ\text{C}$, $V_{CM} = V_S/2$, $R_L > 10\text{ k}\Omega$.

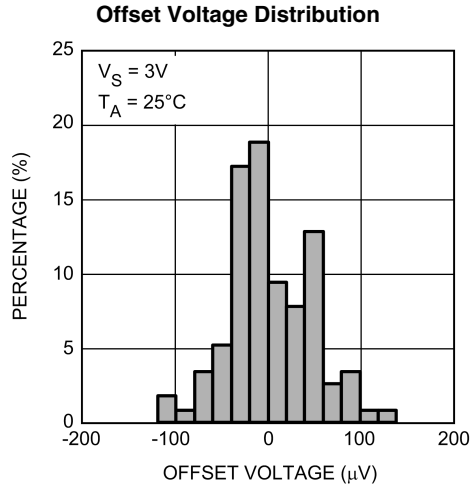

30142136

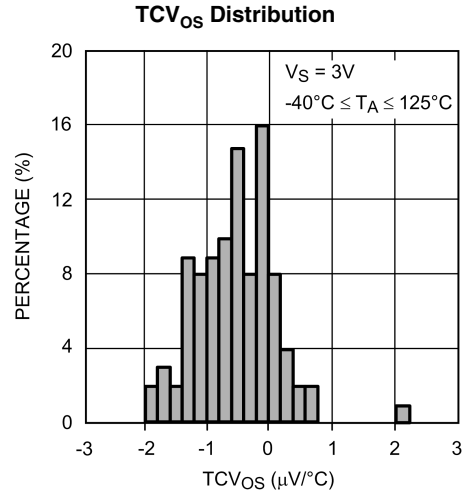

30142141

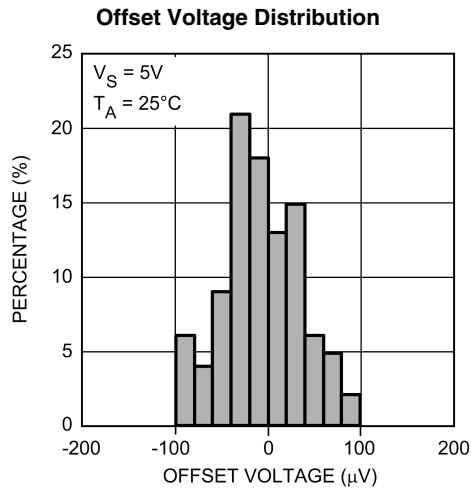

30142137

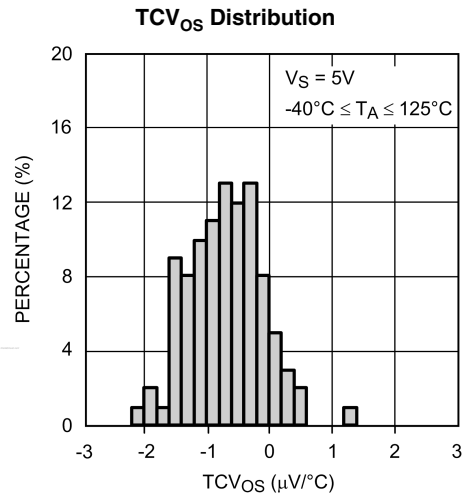

30142142

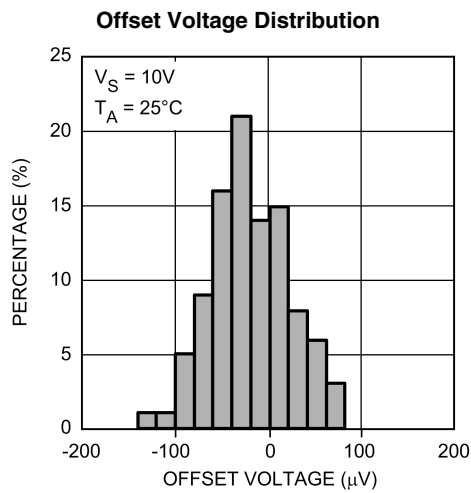

30142138

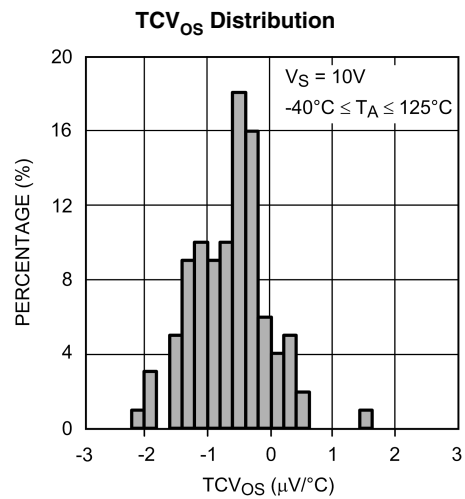

30142143

Offset Voltage vs. Temperature

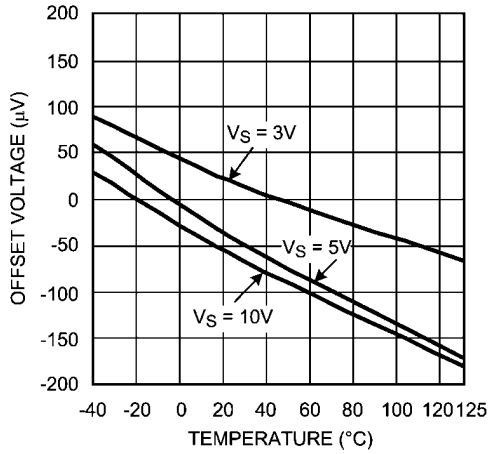

30142106

CMRR vs. Frequency

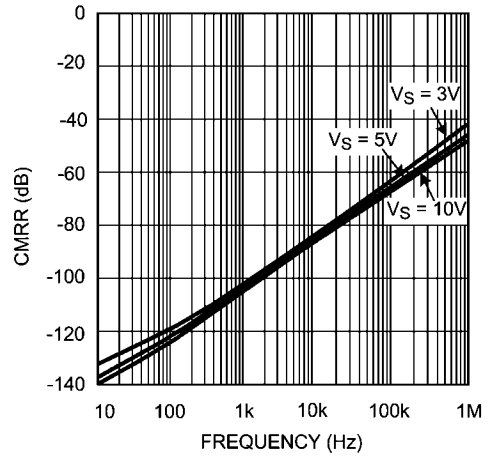

30142150

Offset Voltage vs. Supply Voltage

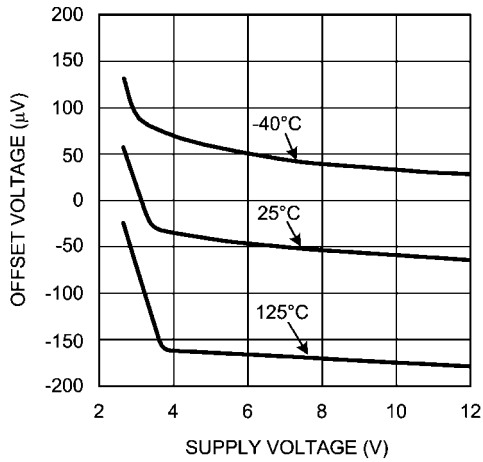

30142110

Offset Voltage vs. V_{CM}

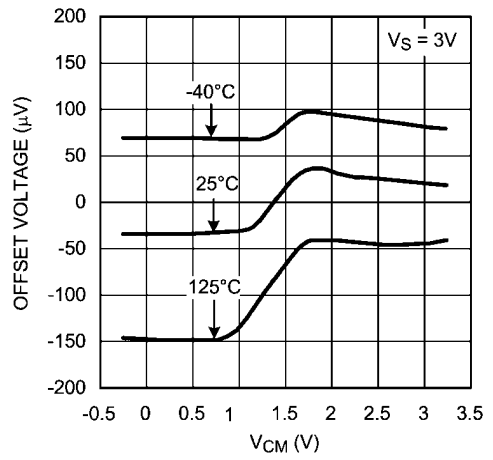

30142107

Offset Voltage vs. V_{CM}

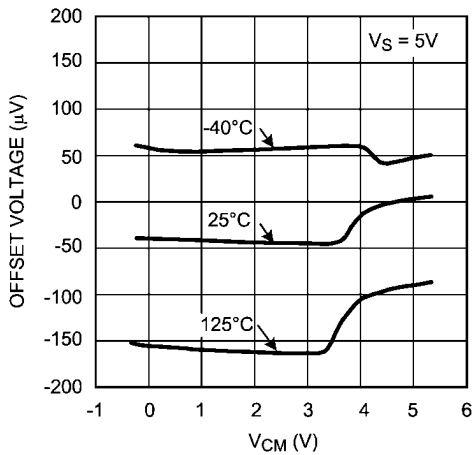

30142108

Offset Voltage vs. V_{CM}

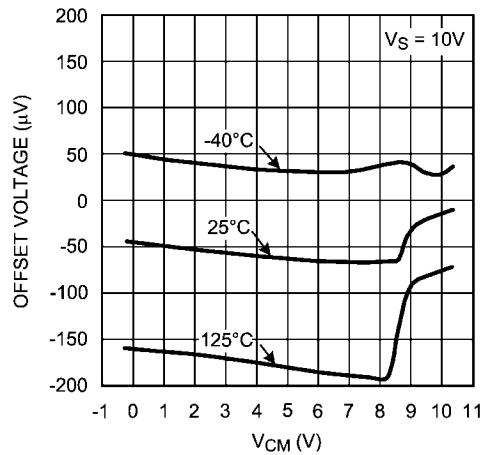

30142109

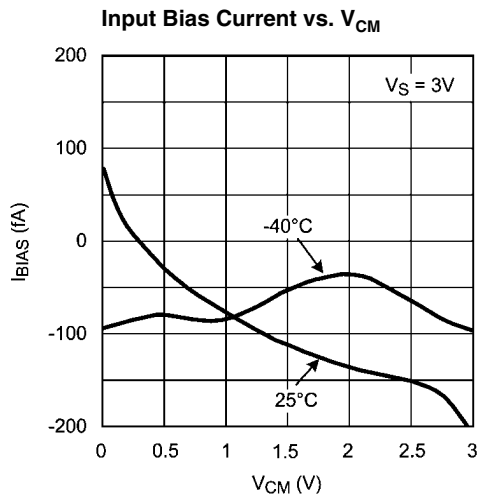

30142146

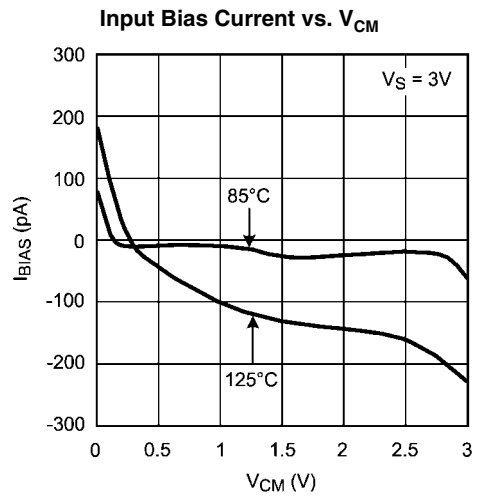

30142130

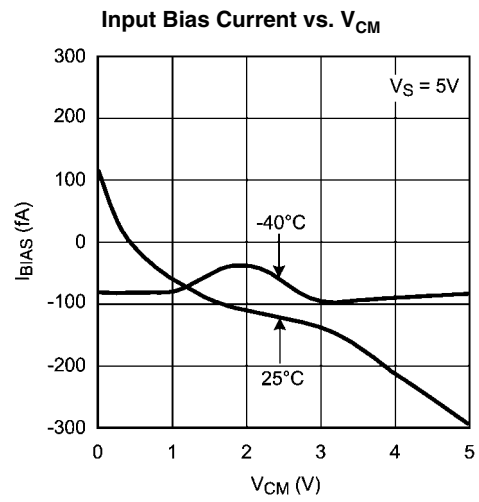

30142147

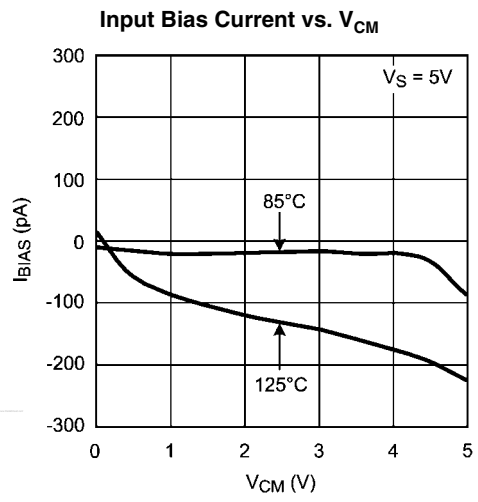

30142131

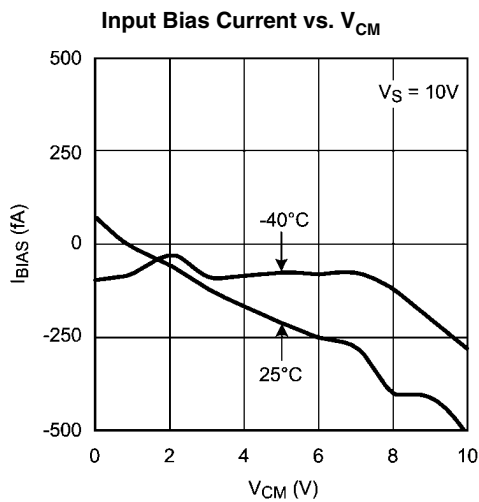

30142148

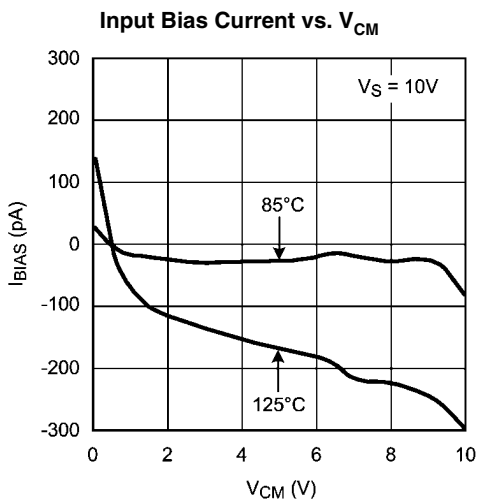

30142149

PSRR vs. Frequency

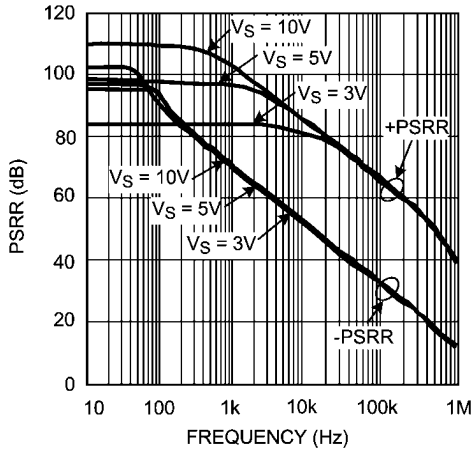

30142145

Supply Current vs. Supply Voltage (Per Channel)

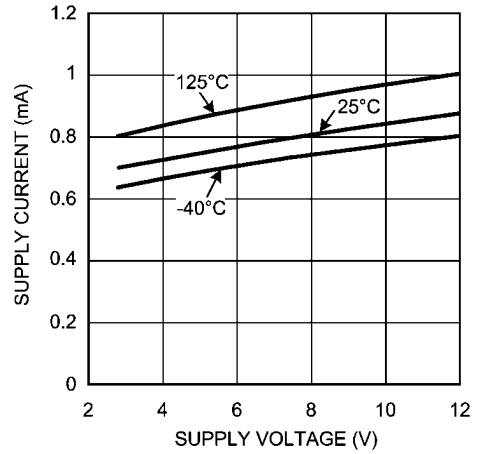

30142111

Sinking Current vs. Supply Voltage

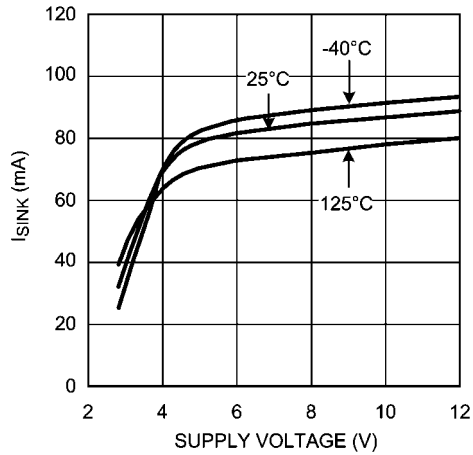

30142113

Sourcing Current vs. Supply Voltage

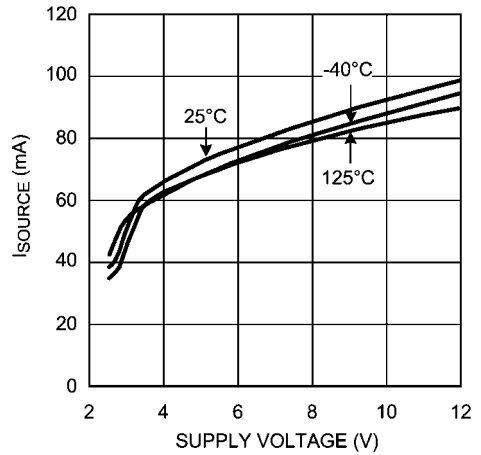

30142112

Output Voltage vs. Output Current

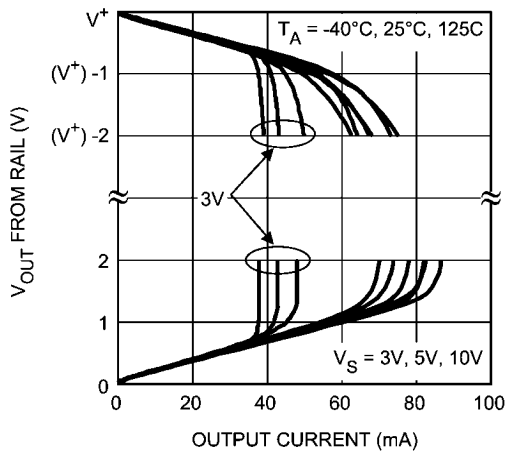

30142116

Slew Rate vs. Supply Voltage

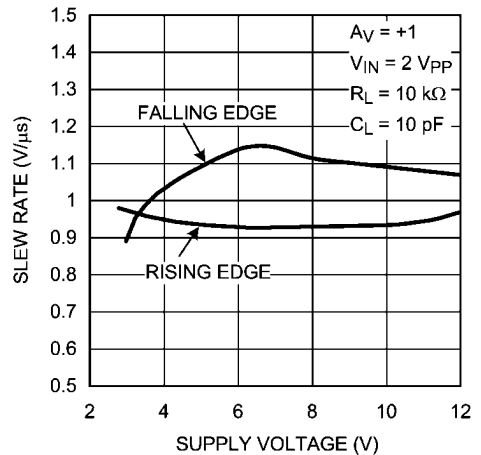

30142117

Open Loop Frequency Response

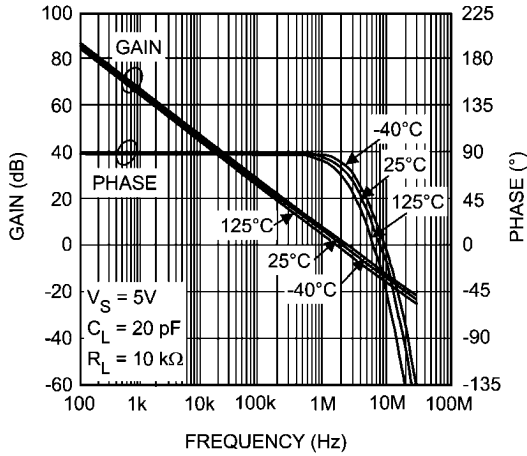

30142115

Open Loop Frequency Response

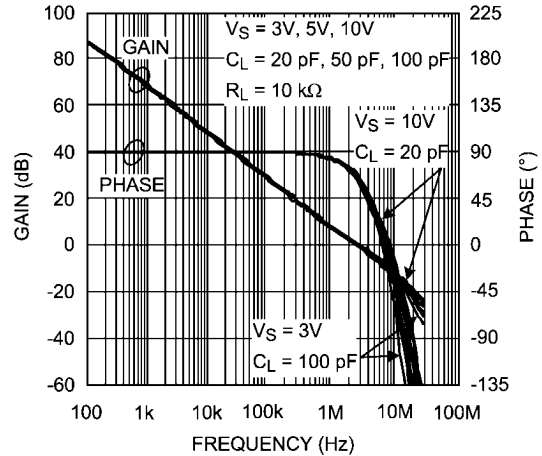

30142114

Large Signal Step Response

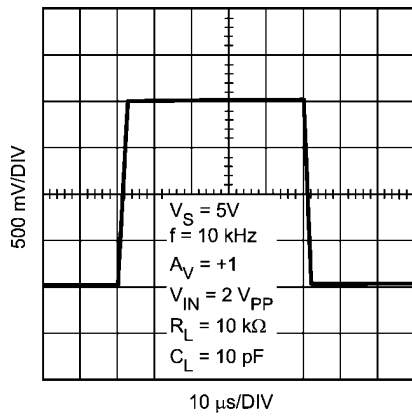

30142118

Small Signal Step Response

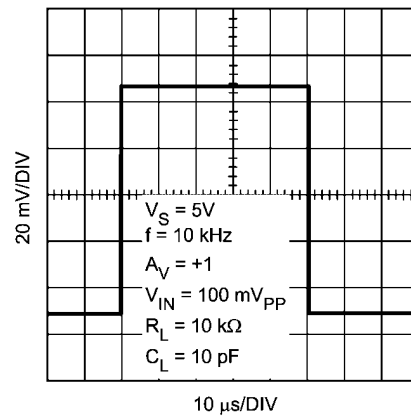

30142120

Large Signal Step Response

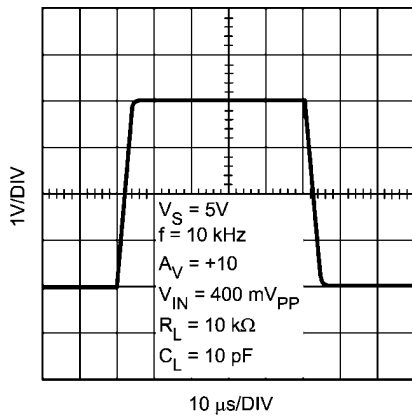

30142119

Small Signal Step Response

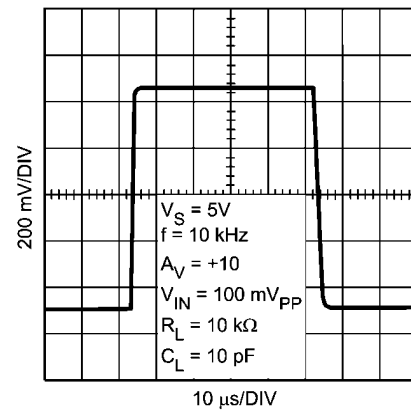

30142126

Input Voltage Noise vs. Frequency

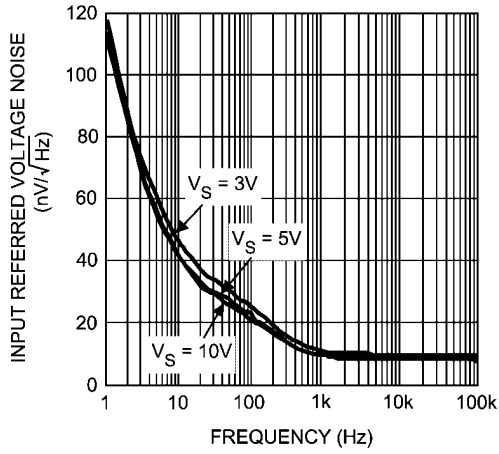

30142127

Open Loop Gain vs. Output Voltage Swing

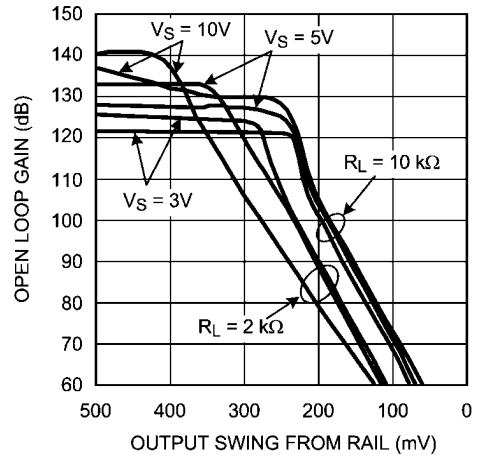

30142152

Output Swing High vs. Supply Voltage

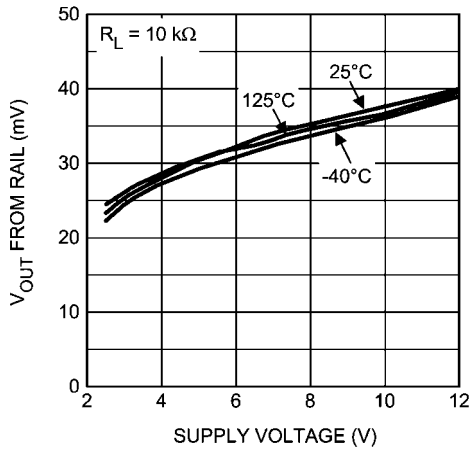

30142133

Output Swing Low vs. Supply Voltage

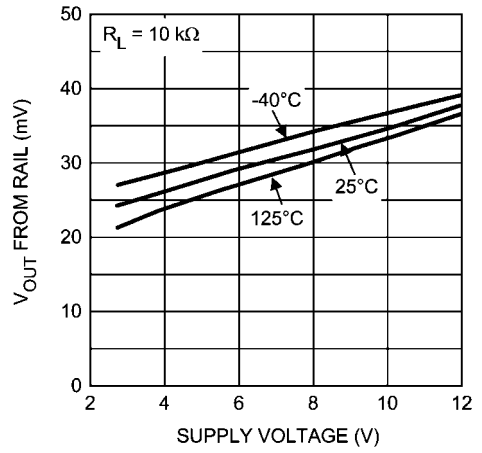

30142135

Output Swing High vs. Supply Voltage

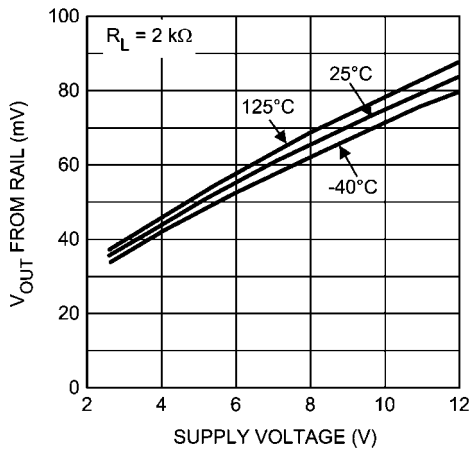

30142132

Output Swing Low vs. Supply Voltage

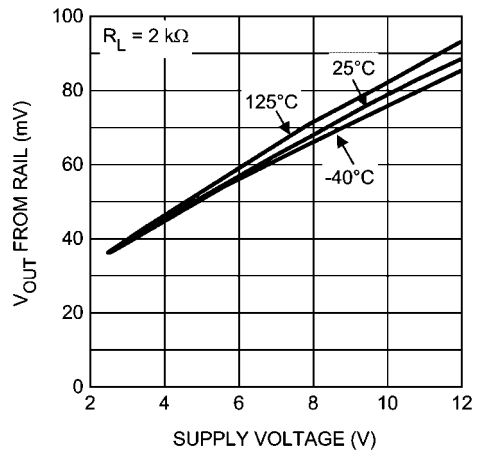

30142134

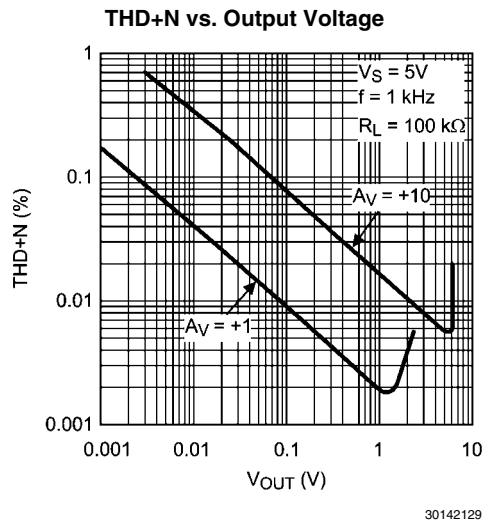
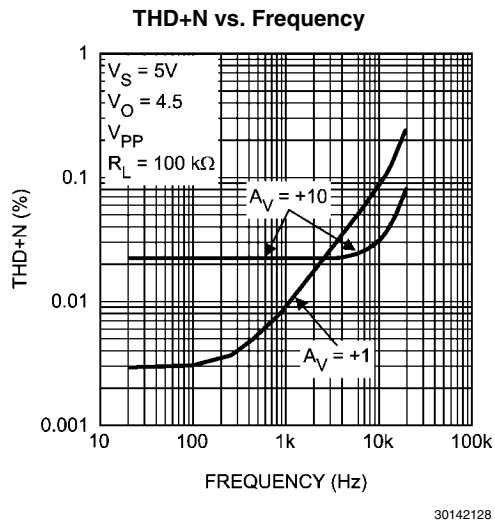

Application Information

SM72501

The SM72501 is a low offset voltage, rail-to-rail input and output precision amplifier with a CMOS input stage and wide supply voltage range of 2.7V to 12V. The SM72501 has a very low input bias current of only ± 200 fA at room temperature.

The wide supply voltage range of 2.7V to 12V over the extensive temperature range of -40°C to 125°C makes the SM72501 an excellent choice for low voltage precision applications with extensive temperature requirements.

The SM72501 has only ± 37 μV of typical input referred offset voltage and this offset is guaranteed to be less than ± 500 μV over temperature. This minimal offset voltage allows more accurate signal detection and amplification in precision applications.

The low input bias current of only ± 200 fA along with the low input referred voltage noise of 9 nV/ $\sqrt{\text{Hz}}$ gives the SM72501 superiority for use in sensor applications. Lower levels of noise from the SM72501 means better signal fidelity and a higher signal-to-noise ratio.

National Semiconductor is heavily committed to precision amplifiers and the market segment they serve. Technical support and extensive characterization data is available for sensitive applications or applications with a constrained error budget.

The SM72501 is offered in the space saving 5-Pin SOT23. This small package is an ideal solution for area constrained PC boards and portable electronics.

CAPACITIVE LOAD

The SM72501 can be connected as a non-inverting unity gain follower. This configuration is the most sensitive to capacitive loading.

The combination of a capacitive load placed on the output of an amplifier along with the amplifier's output impedance creates a phase lag which in turn reduces the phase margin of the amplifier. If the phase margin is significantly reduced, the response will be either underdamped or it will oscillate.

In order to drive heavier capacitive loads, an isolation resistor, R_{ISO} , in [Figure 1](#) should be used. By using this isolation resistor, the capacitive load is isolated from the amplifier's output, and hence, the pole caused by C_L is no longer in the feedback loop. The larger the value of R_{ISO} , the more stable the output voltage will be. If values of R_{ISO} are sufficiently large, the feedback loop will be stable, independent of the value of C_L . However, larger values of R_{ISO} result in reduced output swing and reduced output current drive.

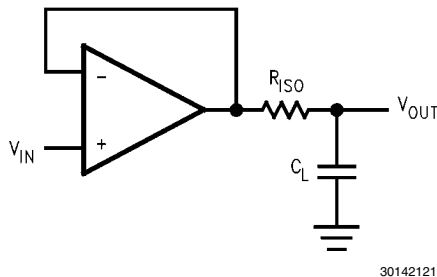

30142121

FIGURE 1. Isolating Capacitive Load

INPUT CAPACITANCE

CMOS input stages inherently have low input bias current and higher input referred voltage noise. The SM72501 enhances this performance by having the low input bias current of only ± 200 fA, as well as, a very low input referred voltage noise of 9 nV/ $\sqrt{\text{Hz}}$. In order to achieve this a larger input stage has been used. This larger input stage increases the input capacitance of the SM72501. The typical value of this input capacitance, C_{IN} , for the SM72501 is 25 pF. The input capacitance will interact with other impedances such as gain and feedback resistors, which are seen on the inputs of the amplifier, to form a pole. This pole will have little or no effect on the output of the amplifier at low frequencies and DC conditions, but will play a bigger role as the frequency increases. At higher frequencies, the presence of this pole will decrease phase margin and will also cause gain peaking. In order to compensate for the input capacitance, care must be taken in choosing the feedback resistors. In addition to being selective in picking values for the feedback resistor, a capacitor can be added to the feedback path to increase stability.

The DC gain of the circuit shown in [Figure 2](#) is simply $-R_2/R_1$.

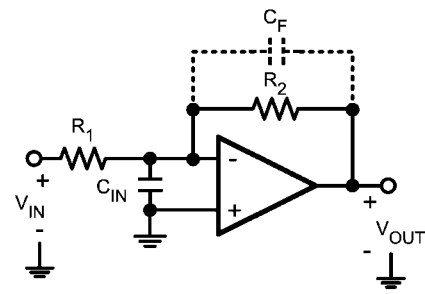

$$A_V = -\frac{V_{\text{OUT}}}{V_{\text{IN}}} = -\frac{R_2}{R_1}$$

30142144

FIGURE 2. Compensating for Input Capacitance

For the time being, ignore C_F . The AC gain of the circuit in [Figure 2](#) can be calculated as follows:

$$\frac{V_{\text{OUT}}}{V_{\text{IN}}}(s) = \frac{-R_2/R_1}{1 + \frac{s}{\left(\frac{A_0 R_1}{R_1 + R_2}\right)} + \frac{s^2}{\left(\frac{A_0}{C_{\text{IN}} R_2}\right)}}$$

This equation is rearranged to find the location of the two poles:

$$P_{1,2} = \frac{-1}{2C_{\text{IN}}} \left[\frac{1}{R_1} + \frac{1}{R_2} \pm \sqrt{\left(\frac{1}{R_1} + \frac{1}{R_2}\right)^2 - \frac{4A_0 C_{\text{IN}}}{R_2}} \right] \quad (1)$$

As shown in [Equation 1](#), as values of R_1 and R_2 are increased, the magnitude of the poles is reduced, which in turn decreases the bandwidth of the amplifier. Whenever possible, it is best to choose smaller feedback resistors. [Figure 3](#) shows the effect of the feedback resistor on the bandwidth of the SM72501.

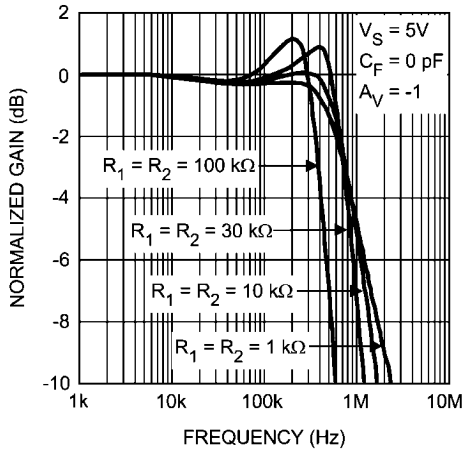

30142154

FIGURE 3. Closed Loop Gain vs. Frequency

Equation 1 has two poles. In most cases, it is the presence of pairs of poles that causes gain peaking. In order to eliminate this effect, the poles should be placed in Butterworth position, since poles in Butterworth position do not cause gain peaking. To achieve a Butterworth pair, the quantity under the square root in Equation 1 should be set to equal -1 . Using this fact and the relation between R_1 and R_2 , $R_2 = -A_V R_1$, the optimum value for R_1 can be found. This is shown in Equation 2. If R_1 is chosen to be larger than this optimum value, gain peaking will occur.

$$R_1 < \frac{(1 - A_V)^2}{2A_0 A_V C_{IN}} \quad (2)$$

In Figure 2, C_F is added to compensate for input capacitance and to increase stability. Additionally, C_F reduces or eliminates the gain peaking that can be caused by having a larger feedback resistor. Figure 4 shows how C_F reduces gain peaking.

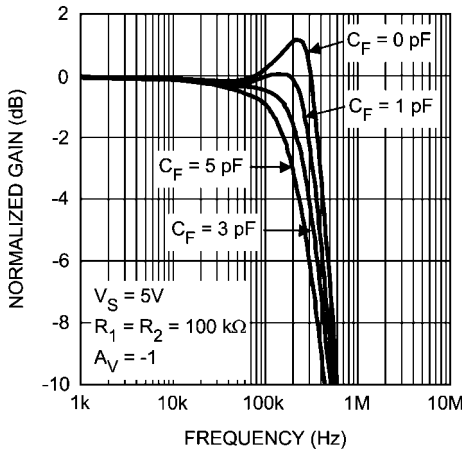

30142155

FIGURE 4. Closed Loop Gain vs. Frequency with Compensation

DIODES BETWEEN THE INPUTS

The SM72501 has a set of anti-parallel diodes between the input pins, as shown in Figure 5. These diodes are present to protect the input stage of the amplifier. At the same time, they limit the amount of differential input voltage that is allowed on the input pins. A differential signal larger than one diode voltage drop might damage the diodes. The differential signal between the inputs needs to be limited to ± 300 mV or the input current needs to be limited to ± 10 mA.

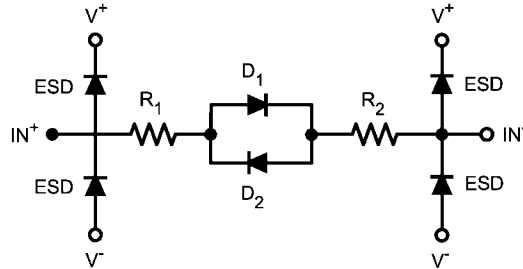

30142125

FIGURE 5. Input of SM72501

PRECISION CURRENT SOURCE

The SM72501 can be used as a precision current source in many different applications. *Figure 6* shows a typical precision current source. This circuit implements a precision voltage controlled current source. Amplifier A1 is a differential amplifier that uses the voltage drop across R_S as the feedback signal. Amplifier A2 is a buffer that eliminates the error current from the load side of the R_S resistor that would flow in the feedback resistor if it were connected to the load side of the R_S resistor. In general, the circuit is stable as long as the closed loop bandwidth of amplifier A2 is greater than the closed loop bandwidth of amplifier A1. Note that if A1 and A2 are the same type of amplifiers, then the feedback around A1 will reduce its bandwidth compared to A2.

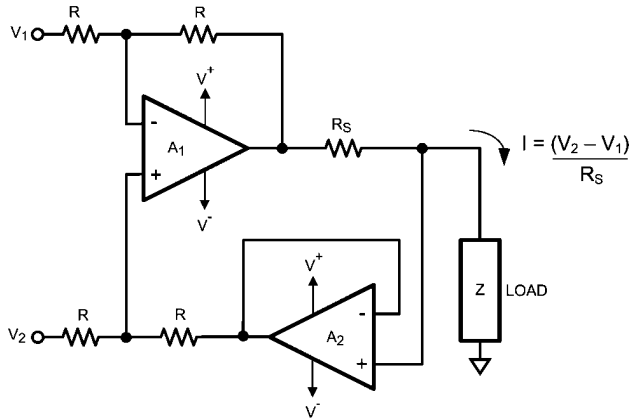

30142105

FIGURE 6. Precision Current Source

The equation for output current can be derived as follows:

$$\frac{V_2 R}{R + R} + \frac{(V_0 - I R_S) R}{R + R} = \frac{V_1 R}{R + R} + \frac{V_0 R}{R + R}$$

Solving for the current I results in the following equation:

$$I = \frac{V_2 - V_1}{R_S}$$

LOW INPUT VOLTAGE NOISE

The SM72501 has a very low input voltage noise of 9 nV/√Hz. This input voltage noise can be further reduced by placing N amplifiers in parallel as shown in *Figure 7*. The total voltage noise on the output of this circuit is divided by the square root of the number of amplifiers used in this parallel

combination. This is because each individual amplifier acts as an independent noise source, and the average noise of independent sources is the quadrature sum of the independent sources divided by the number of sources. For N identical amplifiers, this means:

$$\begin{aligned} \text{REDUCED INPUT VOLTAGE NOISE} &= \frac{1}{N} \sqrt{e_{n1}^2 + e_{n2}^2 + \dots + e_{nN}^2} \\ &= \frac{1}{N} \sqrt{N e_n^2} = \frac{\sqrt{N}}{N} e_n \\ &= \frac{1}{\sqrt{N}} e_n \end{aligned}$$

Figure 7 shows a schematic of this input voltage noise reduction circuit. Typical resistor values are:

$R_G = 10\Omega$, $R_F = 1\text{ k}\Omega$, and $R_O = 1\text{ k}\Omega$.

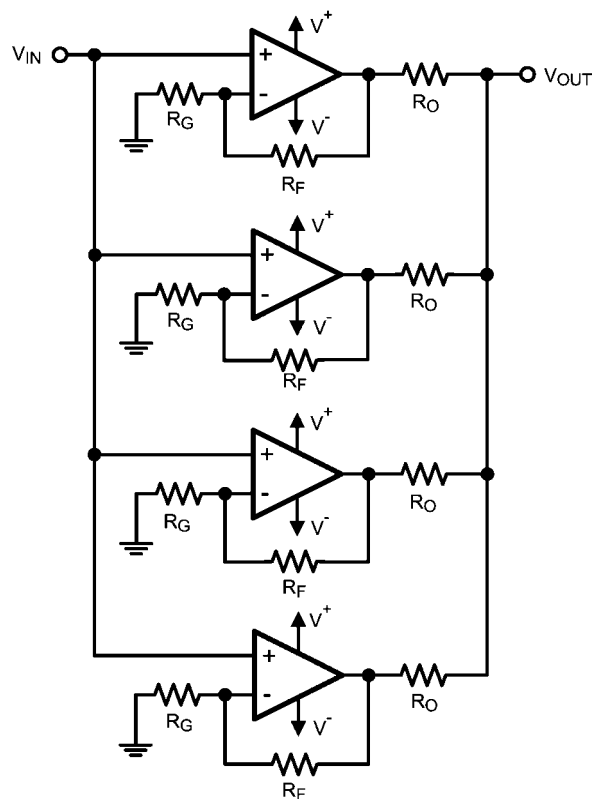

30142156

FIGURE 7. Noise Reduction Circuit

TOTAL NOISE CONTRIBUTION

The SM72501 has very low input bias current, very low input current noise, and very low input voltage noise. As a result, these amplifiers are ideal choices for circuits with high impedance sensor applications.

Figure 8 shows the typical input noise of the SM72501 as a function of source resistance where:

e_n denotes the input referred voltage noise

e_i is the voltage drop across source resistance due to input referred current noise or $e_i = R_S \cdot i_n$

e_t shows the thermal noise of the source resistance

e_{ni} shows the total noise on the input.

Where:

$$e_{ni} = \sqrt{e_n^2 + e_i^2 + e_t^2}$$

The input current noise of the SM72501 is so low that it will not become the dominant factor in the total noise unless source resistance exceeds 300 M Ω , which is an unrealistically high value.

As is evident in Figure 8, at lower R_S values, total noise is dominated by the amplifier's input voltage noise. Once R_S is larger than a few kilo-Ohms, then the dominant noise factor becomes the thermal noise of R_S . As mentioned before, the current noise will not be the dominant noise factor for any practical application.

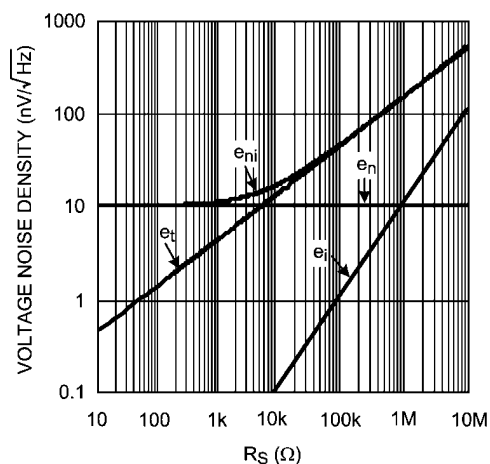

30142158

FIGURE 8. Total Input Noise

HIGH IMPEDANCE SENSOR INTERFACE

Many sensors have high source impedances that may range up to 10 M Ω . The output signal of sensors often needs to be amplified or otherwise conditioned by means of an amplifier. The input bias current of this amplifier can load the sensor's output and cause a voltage drop across the source resistance as shown in Figure 9, where $V_{IN^+} = V_S - I_{BIAS} \cdot R_S$.

The last term, $I_{BIAS} \cdot R_S$, shows the voltage drop across R_S . To prevent errors introduced to the system due to this voltage, an op amp with very low input bias current must be used with high impedance sensors. This is to keep the error contribution by $I_{BIAS} \cdot R_S$ less than the input voltage noise of the amplifier, so that it will not become the dominant noise factor.

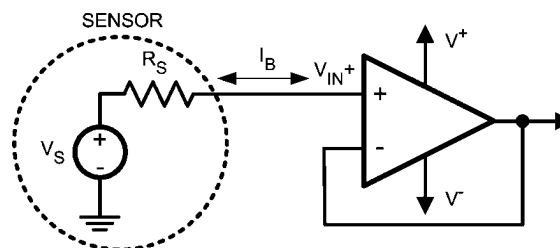

30142159

FIGURE 9. Noise Due to I_{BIAS}

pH electrodes are very high impedance sensors. As their name indicates, they are used to measure the pH of a solution. They usually do this by generating an output voltage which is proportional to the pH of the solution. pH electrodes are calibrated so that they have zero output for a neutral solution, pH = 7, and positive and negative voltages for acidic or alkaline solutions. This means that the output of a pH electrode is bipolar system and has to be level shifted to be used in a single supply system. The rate of change of this voltage is usually shown in mV/pH and is different for different pH sensors. Temperature is also an important factor in a pH electrode reading. The output voltage of the sensor will change with temperature.

Figure 10 shows a typical output voltage spectrum of a pH electrode. Note that the exact values of output voltage will be different for different sensors. In this example, the pH electrode has an output voltage of 59.15 mV/pH at 25°C.

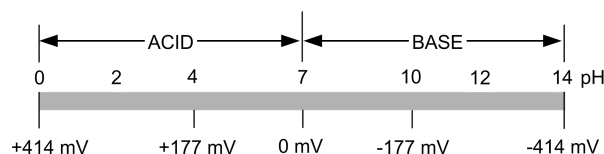

30142160

FIGURE 10. Output Voltage of a pH Electrode

The temperature dependence of a typical pH electrode is shown in Figure 11. As is evident, the output voltage changes with changes in temperature.

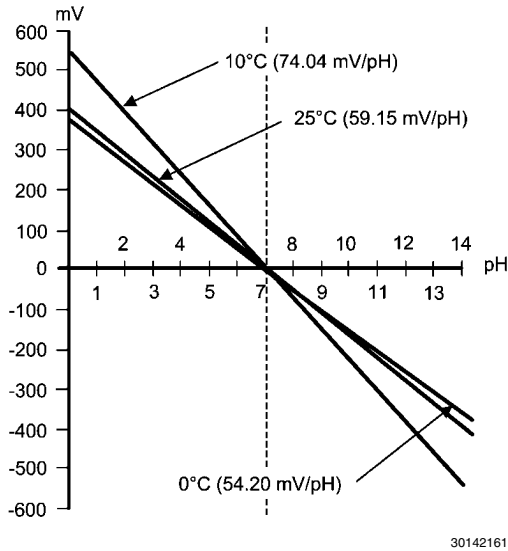

FIGURE 11. Temperature Dependence of a pH Electrode

The schematic shown in Figure 12 is a typical circuit which can be used for pH measurement. The LM35 is a precision integrated circuit temperature sensor. This sensor is differentiated from similar products because it has an output voltage linearly proportional to Celcius measurement, without the need to convert the temperature to Kelvin. The LM35 is used to measure the temperature of the solution and feeds this reading to the Analog to Digital Converter, ADC. This infor-

mation is used by the ADC to calculate the temperature effects on the pH readings. The LM35 needs to have a resistor, R_T in Figure 12, to $-V^+$ in order to be able to read temperatures below 0°C. R_T is not needed if temperatures are not expected to go below zero.

The output of pH electrodes is usually large enough that it does not require much amplification; however, due to the very high impedance, the output of a pH electrode needs to be buffered before it can go to an ADC. Since most ADCs are operated on single supply, the output of the pH electrode also needs to be level shifted. Amplifier A1 buffers the output of the pH electrode with a moderate gain of +2, while A2 provides the level shifting. V_{OUT} at the output of A2 is given by: $V_{OUT} = -2V_{pH} + 1.024V$.

The LM4140A is a precision, low noise, voltage reference used to provide the level shift needed. The ADC used in this application is the ADC12032 which is a 12-bit, 2 channel converter with multiplexers on the inputs and a serial output. The 12-bit ADC enables users to measure pH with an accuracy of 0.003 of a pH unit. Adequate power supply bypassing and grounding is extremely important for ADCs. Recommended bypass capacitors are shown in Figure 12. It is common to share power supplies between different components in a circuit. To minimize the effects of power supply ripples caused by other components, the op amps need to have bypass capacitors on the supply pins. Using the same value capacitors as those used with the ADC are ideal. The combination of these three values of capacitors ensures that AC noise present on the power supply line is grounded and does not interfere with the amplifiers' signal.

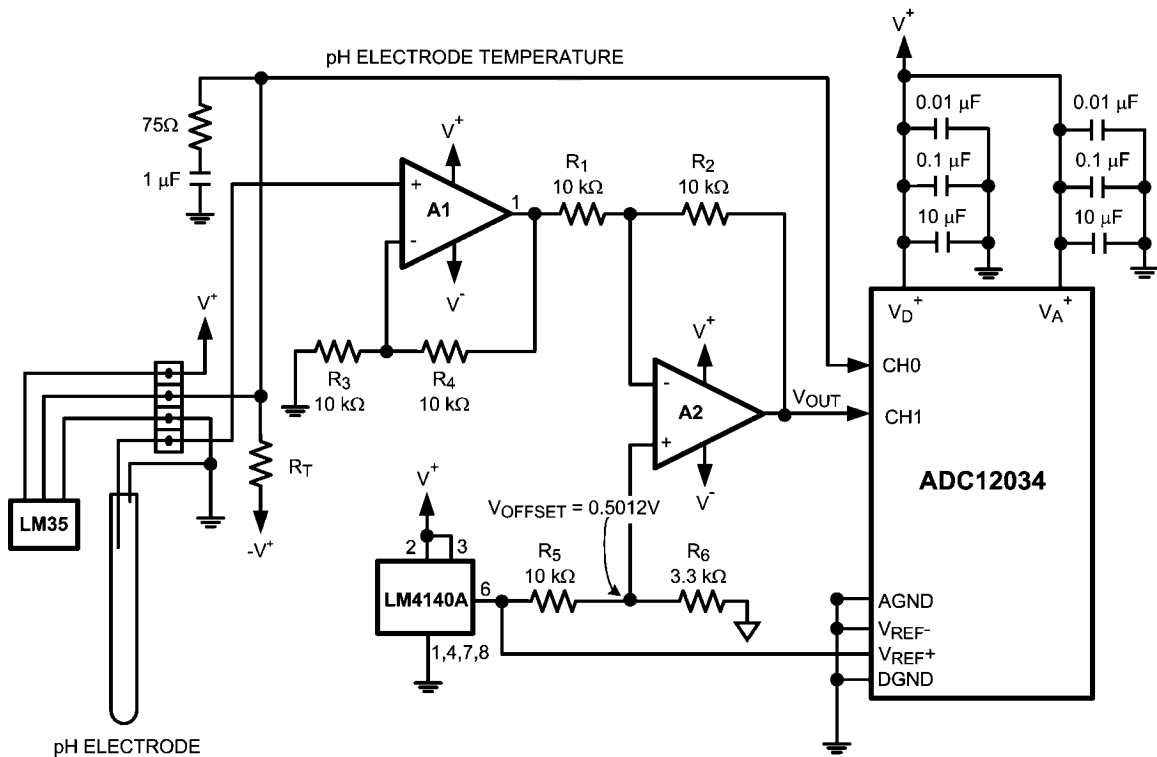
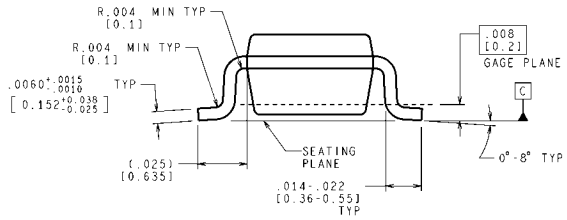
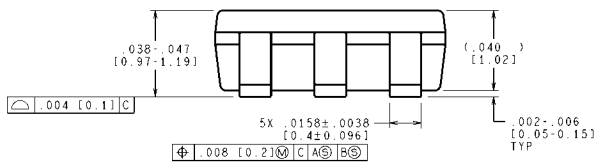
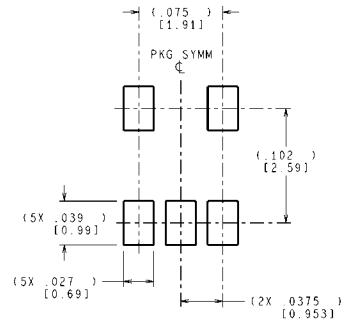
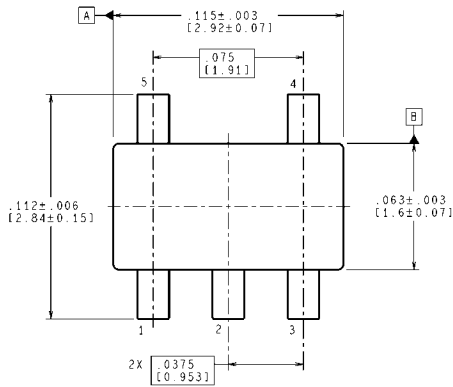

FIGURE 12. pH Measurement Circuit

Physical Dimensions inches (millimeters) unless otherwise noted



CONTROLLING DIMENSION IS INCH
 VALUES IN [] ARE MILLIMETERS
 DIMENSIONS IN () FOR REFERENCE ONLY

5-Pin SOT23
NS Package Number MF05A

MF05A (Rev D)

Notes

For more National Semiconductor product information and proven design tools, visit the following Web sites at:
www.national.com

| Products | | Design Support | |
|--------------------------------|--|------------------------------|--|
| Amplifiers | www.national.com/amplifiers | WEBENCH® Tools | www.national.com/webench |
| Audio | www.national.com/audio | App Notes | www.national.com/appnotes |
| Clock and Timing | www.national.com/timing | Reference Designs | www.national.com/refdesigns |
| Data Converters | www.national.com/adc | Samples | www.national.com/samples |
| Interface | www.national.com/interface | Eval Boards | www.national.com/evalboards |
| LVDS | www.national.com/lvds | Packaging | www.national.com/packaging |
| Power Management | www.national.com/power | Green Compliance | www.national.com/quality/green |
| Switching Regulators | www.national.com/switchers | Distributors | www.national.com/contacts |
| LDOs | www.national.com/ldo | Quality and Reliability | www.national.com/quality |
| LED Lighting | www.national.com/led | Feedback/Support | www.national.com/feedback |
| Voltage References | www.national.com/vref | Design Made Easy | www.national.com/easy |
| PowerWise® Solutions | www.national.com/powerwise | Applications & Markets | www.national.com/solutions |
| Serial Digital Interface (SDI) | www.national.com/sdi | Mil/Aero | www.national.com/milaero |
| Temperature Sensors | www.national.com/tempensors | SolarMagic™ | www.national.com/solarmagic |
| PLL/VCO | www.national.com/wireless | PowerWise® Design University | www.national.com/training |

THE CONTENTS OF THIS DOCUMENT ARE PROVIDED IN CONNECTION WITH NATIONAL SEMICONDUCTOR CORPORATION ("NATIONAL") PRODUCTS. NATIONAL MAKES NO REPRESENTATIONS OR WARRANTIES WITH RESPECT TO THE ACCURACY OR COMPLETENESS OF THE CONTENTS OF THIS PUBLICATION AND RESERVES THE RIGHT TO MAKE CHANGES TO SPECIFICATIONS AND PRODUCT DESCRIPTIONS AT ANY TIME WITHOUT NOTICE. NO LICENSE, WHETHER EXPRESS, IMPLIED, ARISING BY ESTOPPEL OR OTHERWISE, TO ANY INTELLECTUAL PROPERTY RIGHTS IS GRANTED BY THIS DOCUMENT.

TESTING AND OTHER QUALITY CONTROLS ARE USED TO THE EXTENT NATIONAL DEEMS NECESSARY TO SUPPORT NATIONAL'S PRODUCT WARRANTY. EXCEPT WHERE MANDATED BY GOVERNMENT REQUIREMENTS, TESTING OF ALL PARAMETERS OF EACH PRODUCT IS NOT NECESSARILY PERFORMED. NATIONAL ASSUMES NO LIABILITY FOR APPLICATIONS ASSISTANCE OR BUYER PRODUCT DESIGN. BUYERS ARE RESPONSIBLE FOR THEIR PRODUCTS AND APPLICATIONS USING NATIONAL COMPONENTS. PRIOR TO USING OR DISTRIBUTING ANY PRODUCTS THAT INCLUDE NATIONAL COMPONENTS, BUYERS SHOULD PROVIDE ADEQUATE DESIGN, TESTING AND OPERATING SAFEGUARDS.

EXCEPT AS PROVIDED IN NATIONAL'S TERMS AND CONDITIONS OF SALE FOR SUCH PRODUCTS, NATIONAL ASSUMES NO LIABILITY WHATSOEVER, AND NATIONAL DISCLAIMS ANY EXPRESS OR IMPLIED WARRANTY RELATING TO THE SALE AND/OR USE OF NATIONAL PRODUCTS INCLUDING LIABILITY OR WARRANTIES RELATING TO FITNESS FOR A PARTICULAR PURPOSE, MERCHANTABILITY, OR INFRINGEMENT OF ANY PATENT, COPYRIGHT OR OTHER INTELLECTUAL PROPERTY RIGHT.

LIFE SUPPORT POLICY

NATIONAL'S PRODUCTS ARE NOT AUTHORIZED FOR USE AS CRITICAL COMPONENTS IN LIFE SUPPORT DEVICES OR SYSTEMS WITHOUT THE EXPRESS PRIOR WRITTEN APPROVAL OF THE CHIEF EXECUTIVE OFFICER AND GENERAL COUNSEL OF NATIONAL SEMICONDUCTOR CORPORATION. As used herein:

Life support devices or systems are devices which (a) are intended for surgical implant into the body, or (b) support or sustain life and whose failure to perform when properly used in accordance with instructions for use provided in the labeling can be reasonably expected to result in a significant injury to the user. A critical component is any component in a life support device or system whose failure to perform can be reasonably expected to cause the failure of the life support device or system or to affect its safety or effectiveness.

National Semiconductor and the National Semiconductor logo are registered trademarks of National Semiconductor Corporation. All other brand or product names may be trademarks or registered trademarks of their respective holders.

Copyright© 2011 National Semiconductor Corporation

For the most current product information visit us at www.national.com



**National Semiconductor
Americas Technical
Support Center**
Email: support@nsc.com
Tel: 1-800-272-9959

**National Semiconductor Europe
Technical Support Center**
Email: europe.support@nsc.com

**National Semiconductor Asia
Pacific Technical Support Center**
Email: ap.support@nsc.com

**National Semiconductor Japan
Technical Support Center**
Email: jpn.feedback@nsc.com

IMPORTANT NOTICE

Texas Instruments Incorporated and its subsidiaries (TI) reserve the right to make corrections, modifications, enhancements, improvements, and other changes to its products and services at any time and to discontinue any product or service without notice. Customers should obtain the latest relevant information before placing orders and should verify that such information is current and complete. All products are sold subject to TI's terms and conditions of sale supplied at the time of order acknowledgment.

TI warrants performance of its hardware products to the specifications applicable at the time of sale in accordance with TI's standard warranty. Testing and other quality control techniques are used to the extent TI deems necessary to support this warranty. Except where mandated by government requirements, testing of all parameters of each product is not necessarily performed.

TI assumes no liability for applications assistance or customer product design. Customers are responsible for their products and applications using TI components. To minimize the risks associated with customer products and applications, customers should provide adequate design and operating safeguards.

TI does not warrant or represent that any license, either express or implied, is granted under any TI patent right, copyright, mask work right, or other TI intellectual property right relating to any combination, machine, or process in which TI products or services are used. Information published by TI regarding third-party products or services does not constitute a license from TI to use such products or services or a warranty or endorsement thereof. Use of such information may require a license from a third party under the patents or other intellectual property of the third party, or a license from TI under the patents or other intellectual property of TI.

Reproduction of TI information in TI data books or data sheets is permissible only if reproduction is without alteration and is accompanied by all associated warranties, conditions, limitations, and notices. Reproduction of this information with alteration is an unfair and deceptive business practice. TI is not responsible or liable for such altered documentation. Information of third parties may be subject to additional restrictions.

Resale of TI products or services with statements different from or beyond the parameters stated by TI for that product or service voids all express and any implied warranties for the associated TI product or service and is an unfair and deceptive business practice. TI is not responsible or liable for any such statements.

TI products are not authorized for use in safety-critical applications (such as life support) where a failure of the TI product would reasonably be expected to cause severe personal injury or death, unless officers of the parties have executed an agreement specifically governing such use. Buyers represent that they have all necessary expertise in the safety and regulatory ramifications of their applications, and acknowledge and agree that they are solely responsible for all legal, regulatory and safety-related requirements concerning their products and any use of TI products in such safety-critical applications, notwithstanding any applications-related information or support that may be provided by TI. Further, Buyers must fully indemnify TI and its representatives against any damages arising out of the use of TI products in such safety-critical applications.

TI products are neither designed nor intended for use in military/aerospace applications or environments unless the TI products are specifically designated by TI as military-grade or "enhanced plastic." Only products designated by TI as military-grade meet military specifications. Buyers acknowledge and agree that any such use of TI products which TI has not designated as military-grade is solely at the Buyer's risk, and that they are solely responsible for compliance with all legal and regulatory requirements in connection with such use.

TI products are neither designed nor intended for use in automotive applications or environments unless the specific TI products are designated by TI as compliant with ISO/TS 16949 requirements. Buyers acknowledge and agree that, if they use any non-designated products in automotive applications, TI will not be responsible for any failure to meet such requirements.

Following are URLs where you can obtain information on other Texas Instruments products and application solutions:

Products

| | |
|------------------------|--|
| Audio | www.ti.com/audio |
| Amplifiers | amplifier.ti.com |
| Data Converters | dataconverter.ti.com |
| DLP® Products | www.dlp.com |
| DSP | dsp.ti.com |
| Clocks and Timers | www.ti.com/clocks |
| Interface | interface.ti.com |
| Logic | logic.ti.com |
| Power Mgmt | power.ti.com |
| Microcontrollers | microcontroller.ti.com |
| RFID | www.ti-rfid.com |
| OMAP Mobile Processors | www.ti.com/omap |
| Wireless Connectivity | www.ti.com/wirelessconnectivity |

Applications

| | |
|-------------------------------|--|
| Communications and Telecom | www.ti.com/communications |
| Computers and Peripherals | www.ti.com/computers |
| Consumer Electronics | www.ti.com/consumer-apps |
| Energy and Lighting | www.ti.com/energy |
| Industrial | www.ti.com/industrial |
| Medical | www.ti.com/medical |
| Security | www.ti.com/security |
| Space, Avionics and Defense | www.ti.com/space-avionics-defense |
| Transportation and Automotive | www.ti.com/automotive |
| Video and Imaging | www.ti.com/video |

TI E2E Community Home Page

e2e.ti.com

Mailing Address: Texas Instruments, Post Office Box 655303, Dallas, Texas 75265
Copyright © 2011, Texas Instruments Incorporated