

## Dual N-Channel Enhancement Mode MOSFET

### Features

- **Channel 1**  
30V/48A,  
 $R_{DS(ON)} = 7m\Omega$  (max.) @  $V_{GS} = 10V$   
 $R_{DS(ON)} = 10m\Omega$  (max.) @  $V_{GS} = 4.5V$
- **Channel 2**  
30V/50A,  
 $R_{DS(ON)} = 3.3m\Omega$  (max.) @  $V_{GS} = 10V$   
 $R_{DS(ON)} = 5.2m\Omega$  (max.) @  $V_{GS} = 4.5V$
- 100% UIS Tested
- Reliable and Rugged
- Lead Free Available (RoHS Compliant)

### Applications

- Power Management in Desktop Computer or DC/DC Converters.

### Pin Description

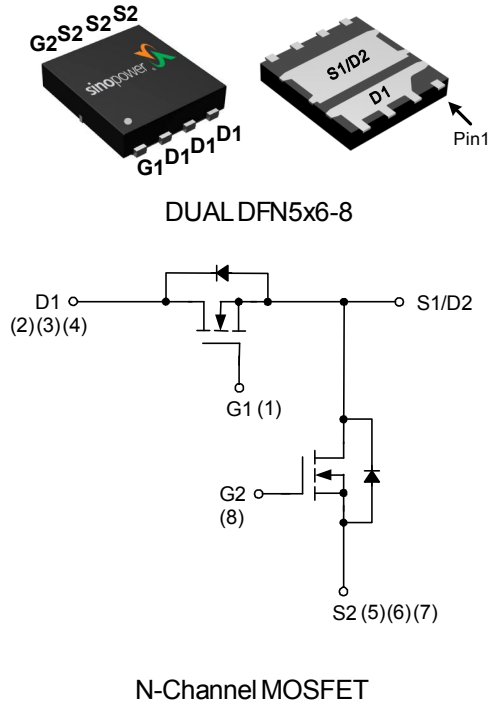

### Ordering and Marking Information

<p>SM7305ES □□□-□□□</p> <pre>     □□□-□□□                            --- Assembly Material              --- Handling Code              --- Temperature Range              --- Package Code                 </pre>	<p>Package Code KP : DFN5x6-8</p> <p>Operating Junction Temperature Range C : -55 to 150 °C</p> <p>Handling Code TR : Tape &amp; Reel (2500ea/reel)</p> <p>Assembly Material G : Halogen and Lead Free Device</p>
<p>SM7305ES KP : </p>	<p>XXXXX - Lot Code</p>

Note : SINOPOWER lead-free products contain molding compounds/die attach materials and 100% matte tin plate termination finish; which are fully compliant with RoHS. SINOPOWER lead-free products meet or exceed the lead-free requirements of IPC/JEDEC J-STD-020D for MSL classification at lead-free peak reflow temperature. SINOPOWER defines "Green" to mean lead-free (RoHS compliant) and halogen free (Br or Cl does not exceed 900ppm by weight in homogeneous material and total of Br and Cl does not exceed 1500ppm by weight).

SINOPOWER reserves the right to make changes to improve reliability or manufacturability without notice, and advise customers to obtain the latest version of relevant information to verify before placing orders.

## Absolute Maximum Ratings ( $T_A = 25^\circ\text{C}$ unless otherwise noted)

Symbol	Parameter	Channel 1	Channel 2	Unit	
<b>Common Ratings</b> ( $T_A=25^\circ\text{C}$ Unless Otherwise Noted)					
$V_{DSS}$	Drain-Source Voltage	30		V	
$V_{GSS}$	Gate-Source Voltage	$\pm 20$			
$T_J$	Maximum Junction Temperature	150		$^\circ\text{C}$	
$T_{STG}$	Storage Temperature Range	-55 to 150			
$I_S$	Diode Continuous Forward Current	$T_C=25^\circ\text{C}$	28	50 <sup>a</sup>	A
$I_D$	Continuous Drain Current	$T_C=25^\circ\text{C}$	48	50 <sup>a</sup>	
		$T_C=100^\circ\text{C}$	30	31.6	
$I_{DM}$	Pulsed Drain Current	$T_C=25^\circ\text{C}$	120 <sup>b</sup>	150 <sup>b</sup>	
$P_D$	Maximum Power Dissipation	$T_C=25^\circ\text{C}$	25	41	W
		$T_C=100^\circ\text{C}$	10	16	
$R_{\theta JC}$	Thermal Resistance-Junction to Case	Steady State	5	3	$^\circ\text{C/W}$
$I_D$	Continuous Drain Current	$T_A=25^\circ\text{C}$	11	18	A
		$T_A=70^\circ\text{C}$	8.7	14.4	
$P_D$	Maximum Power Dissipation	$T_A=25^\circ\text{C}$	1.56	1.78	W
		$T_A=70^\circ\text{C}$	1	1.13	
$R_{\theta JA}$	Thermal Resistance-Junction to Ambient	$t \leq 10\text{s}$	40	30	$^\circ\text{C/W}$
		Steady State	80	70	
$I_{AS}^c$	Avalanche Current, Single pulse ( $L=0.1\text{mH}$ )		27	50	A
$E_{AS}^c$	Avalanche Energy, Single pulse ( $L=0.1\text{mH}$ )		35	125	mJ

Note a : Package is limited to 50A.

Note b : Pulse width limited by max. junction temperature.

Note c : UIS tested and pulse width limited by maximum junction temperature  $150^\circ\text{C}$  (initial temperature  $T_J=25^\circ\text{C}$ ).

## Channel 1 Electrical Characteristics (T<sub>A</sub> = 25°C unless otherwise noted)

Symbol	Parameter	Test Conditions	Channel 1			Unit
			Min.	Typ.	Max.	
<b>Static Characteristics</b>						
BV <sub>DSS</sub>	Drain-Source Breakdown Voltage	V <sub>GS</sub> =0V, I <sub>DS</sub> =250μA	30	-	-	V
I <sub>DSS</sub>	Zero Gate Voltage Drain Current	V <sub>DS</sub> =24V, V <sub>GS</sub> =0V T <sub>J</sub> =85°C	-	-	1	μA
			-	-	30	
V <sub>GS(th)</sub>	Gate Threshold Voltage	V <sub>DS</sub> =V <sub>GS</sub> , I <sub>DS</sub> =250μA	1.5	1.8	2.5	V
I <sub>GSS</sub>	Gate Leakage Current	V <sub>GS</sub> =±20V, V <sub>DS</sub> =0V	-	-	±100	nA
R <sub>DS(ON)</sub> <sup>c</sup>	Drain-Source On-state Resistance	V <sub>GS</sub> =10V, I <sub>DS</sub> =15A T <sub>J</sub> =125°C	-	5.8	7	mΩ
			-	8.4	-	
			-	7.7	10	
Gfs	Forward Transconductance	V <sub>DS</sub> =5V, I <sub>DS</sub> =15A	-	29	-	S
<b>Diode Characteristics</b>						
V <sub>SD</sub> <sup>c</sup>	Diode Forward Voltage	I <sub>SD</sub> =2A, V <sub>GS</sub> =0V	-	0.75	1.1	V
t <sub>rr</sub>	Reverse Recovery Time	I <sub>DS</sub> =15A, dI <sub>SD</sub> /dt=100A/μs	-	12	-	ns
t <sub>a</sub>	Charge Time		-	6	-	
t <sub>b</sub>	Discharge Time		-	6	-	
Q <sub>rr</sub>	Reverse Recovery Charge		-	2.9	-	
<b>Dynamic Characteristics<sup>d</sup></b>						
R <sub>G</sub>	Gate Resistance	V <sub>GS</sub> =0V, V <sub>DS</sub> =0V, F=1MHz	0.5	0.7	1.5	Ω
C <sub>iss</sub>	Input Capacitance	V <sub>GS</sub> =0V, V <sub>DS</sub> =15V, Frequency=1.0MHz	980	1180	1400	pF
C <sub>oss</sub>	Output Capacitance		158	180	218	
C <sub>rss</sub>	Reverse Transfer Capacitance		90	110	130	
t <sub>d(ON)</sub>	Turn-on Delay Time	V <sub>DD</sub> =15V, R <sub>L</sub> =15Ω, I <sub>DS</sub> =1A, V <sub>GEN</sub> =10V, R <sub>G</sub> =6Ω	-	9	14	ns
t <sub>r</sub>	Turn-on Rise Time		-	8	13	
t <sub>d(OFF)</sub>	Turn-off Delay Time		-	25	40	
t <sub>f</sub>	Turn-off Fall Time		-	8	14	
<b>Gate Charge Characteristics<sup>d</sup></b>						
Q <sub>g</sub>	Total Gate Charge	V <sub>DS</sub> =15V, V <sub>GS</sub> =4.5V, I <sub>DS</sub> =15A	-	10	12	nC
Q <sub>g</sub>	Total Gate Charge		-	20	24	
Q <sub>gth</sub>	Threshold Gate Charge	V <sub>DS</sub> =15V, V <sub>GS</sub> =10V, I <sub>DS</sub> =15A	-	2.2	2.7	
Q <sub>gs</sub>	Gate-Source Charge		-	4	4.5	
Q <sub>gd</sub>	Gate-Drain Charge		-	3.8	4.5	

Note c : Pulse test ; pulse width≤300μs, duty cycle≤2%.

Note d : Guaranteed by design, not subject to production testing.

## Channel 2 Electrical Characteristics (T<sub>A</sub> = 25°C unless otherwise noted)

Symbol	Parameter	Test Conditions	Channel 2			Unit
			Min.	Typ.	Max.	
<b>Static Characteristics</b>						
BV <sub>DSS</sub>	Drain-Source Breakdown Voltage	V <sub>GS</sub> =0V, I <sub>DS</sub> =250μA	30	-	-	V
I <sub>DSS</sub>	Zero Gate Voltage Drain Current	V <sub>DS</sub> =24V, V <sub>GS</sub> =0V T <sub>J</sub> =85°C	-	-	1	μA
			-	-	30	
V <sub>GS(th)</sub>	Gate Threshold Voltage	V <sub>DS</sub> =V <sub>GS</sub> , I <sub>DS</sub> =250μA	1.5	1.8	2.5	V
I <sub>GSS</sub>	Gate Leakage Current	V <sub>GS</sub> =±20V, V <sub>DS</sub> =0V	-	-	±100	nA
R <sub>DS(ON)</sub> <sup>c</sup>	Drain-Source On-state Resistance	V <sub>GS</sub> =10V, I <sub>DS</sub> =30A T <sub>J</sub> =125°C	-	2.7	3.3	mΩ
			-	3.8	-	
		V <sub>GS</sub> =4.5V, I <sub>DS</sub> =20A	-	4	5.2	
Gfs	Forward Transconductance	V <sub>DS</sub> =5V, I <sub>DS</sub> =20A	-	40	-	S
<b>Diode Characteristics</b>						
V <sub>SD</sub> <sup>c</sup>	Diode Forward Voltage	I <sub>SD</sub> =20A, V <sub>GS</sub> =0V	-	0.8	1.1	V
t <sub>rr</sub>	Reverse Recovery Time	I <sub>DS</sub> =30A, di <sub>SD</sub> /dt=100A/μs	-	22	-	ns
t <sub>a</sub>	Charge Time		-	13	-	
t <sub>b</sub>	Discharge Time		-	9	-	
Q <sub>rr</sub>	Reverse Recovery Charge		-	9.6	-	
<b>Dynamic Characteristics<sup>d</sup></b>						
R <sub>G</sub>	Gate Resistance	V <sub>GS</sub> =0V, V <sub>DS</sub> =0V, F=1MHz	0.5	0.9	1.5	Ω
C <sub>iss</sub>	Input Capacitance	V <sub>GS</sub> =0V, V <sub>DS</sub> =15V, Frequency=1.0MHz	1984	2480	2976	pF
C <sub>oss</sub>	Output Capacitance		385	550	715	
C <sub>rss</sub>	Reverse Transfer Capacitance		150	250	350	
t <sub>d(ON)</sub>	Turn-on Delay Time	V <sub>DD</sub> =15V, R <sub>L</sub> =15Ω, I <sub>DS</sub> =1A, V <sub>GEN</sub> =10V, R <sub>G</sub> =6Ω	-	17	32	ns
t <sub>r</sub>	Turn-on Rise Time		-	11	21	
t <sub>d(OFF)</sub>	Turn-off Delay Time		-	47	86	
t <sub>f</sub>	Turn-off Fall Time		-	21	39	
<b>Gate Charge Characteristics<sup>d</sup></b>						
Q <sub>g</sub>	Total Gate Charge	V <sub>DS</sub> =15V, V <sub>GS</sub> =4.5V, I <sub>DS</sub> =30A	-	20	28	nC
Q <sub>g</sub>	Total Gate Charge		-	43	60	
Q <sub>gth</sub>	Threshold Gate Charge	V <sub>DS</sub> =15V, V <sub>GS</sub> =10V, I <sub>DS</sub> =30A	-	3.6	5	
Q <sub>gs</sub>	Gate-Source Charge		-	7	9.8	
Q <sub>gd</sub>	Gate-Drain Charge		-	9	12.6	

Note c : Pulse test; pulse width≤300μs, duty cycle≤2%.

Note d : Guaranteed by design, not subject to production testing.

## Channel 1 Typical Operating Characteristics

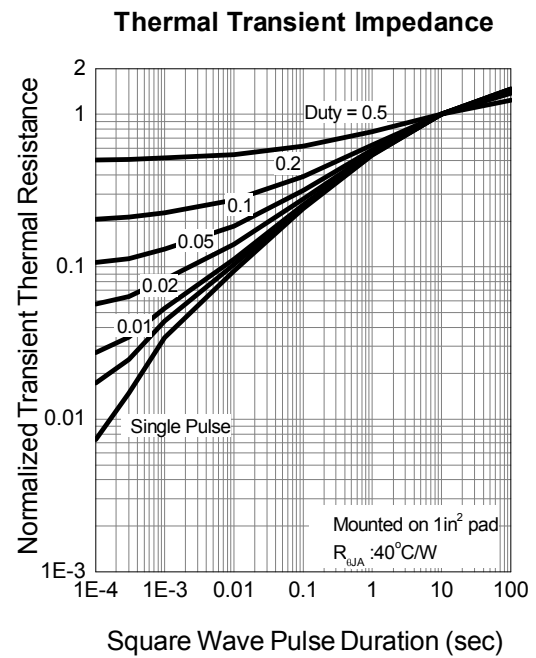
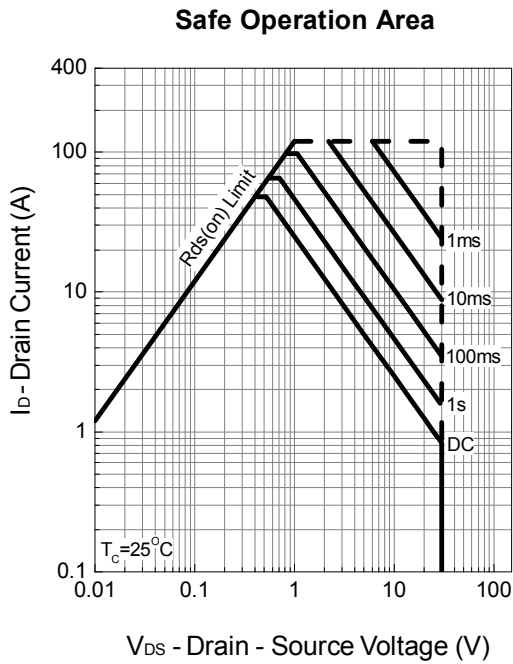
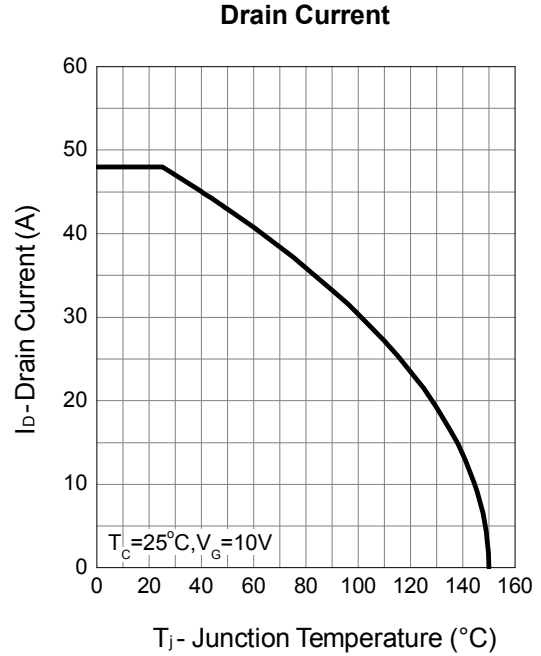
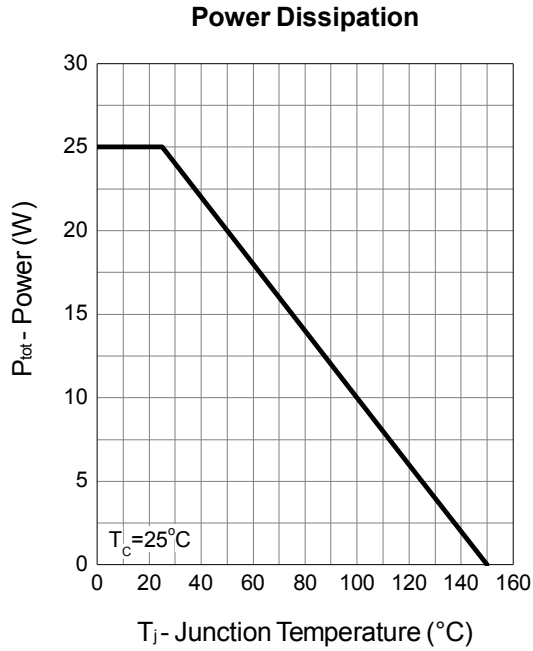

## Channel 1 Typical Operating Characteristics (Cont.)

Output Characteristics

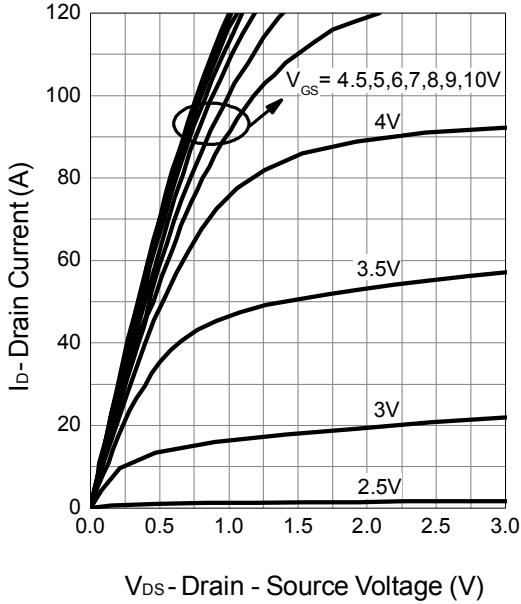

Drain-Source On Resistance

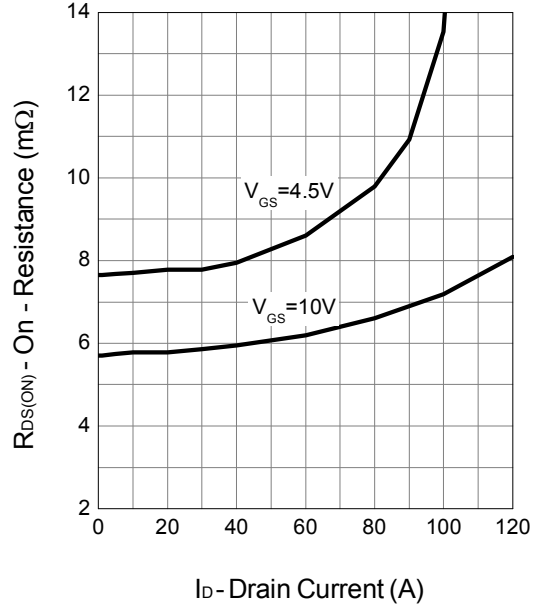

Gate-Source On Resistance

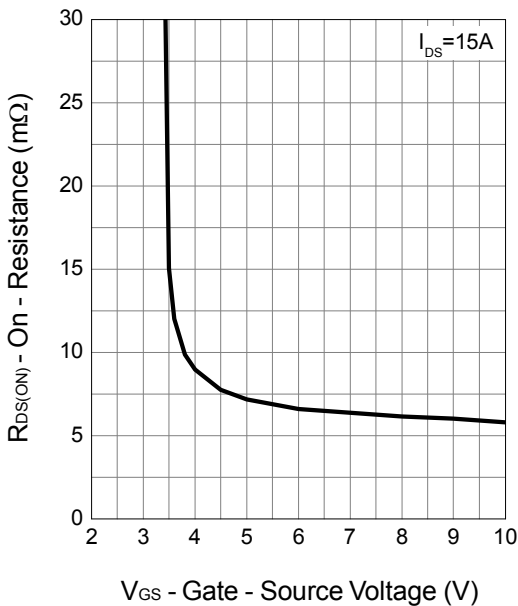

Gate Threshold Voltage

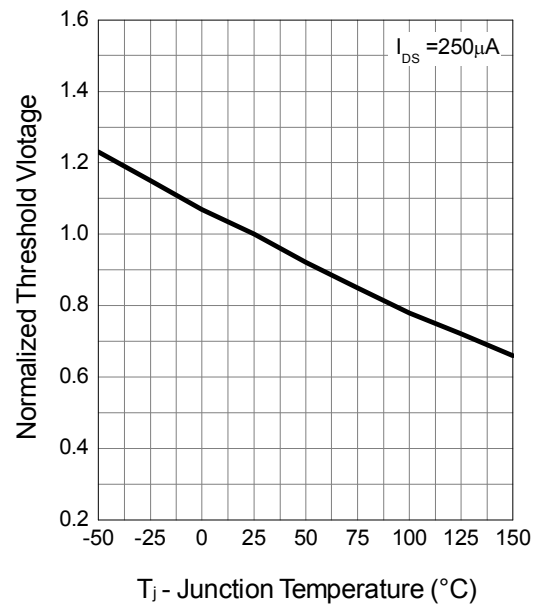

Channel 1 Typical Operating Characteristics (Cont.)

Drain-Source On Resistance

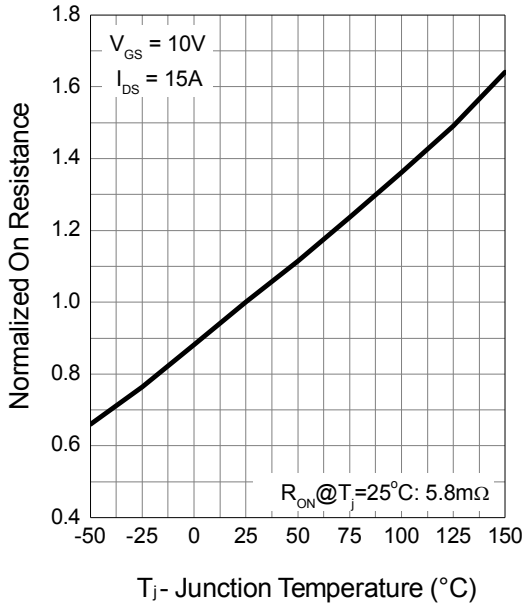

Source-Drain Diode Forward

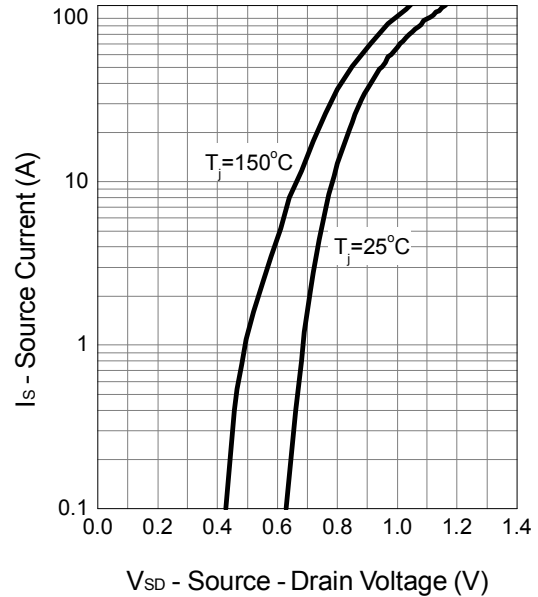

Capacitance

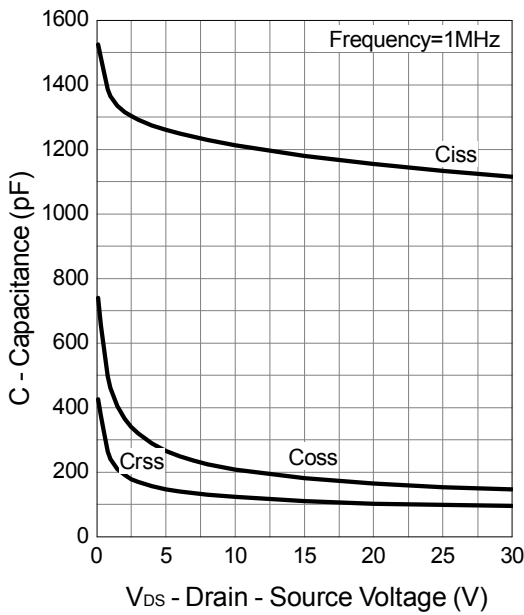

Gate Charge

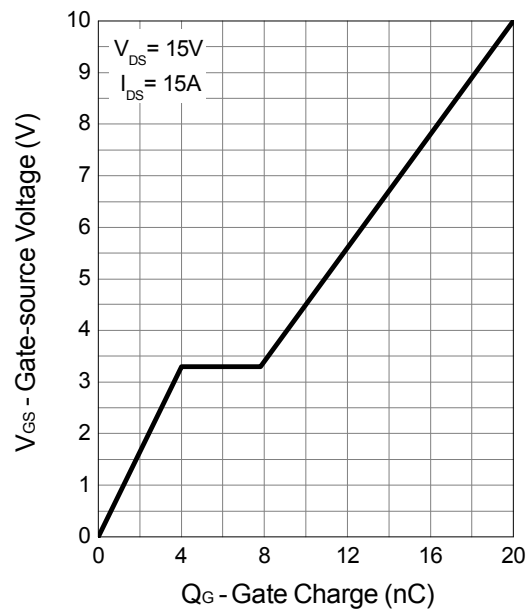

Channel 1 Typical Operating Characteristics (Cont.)

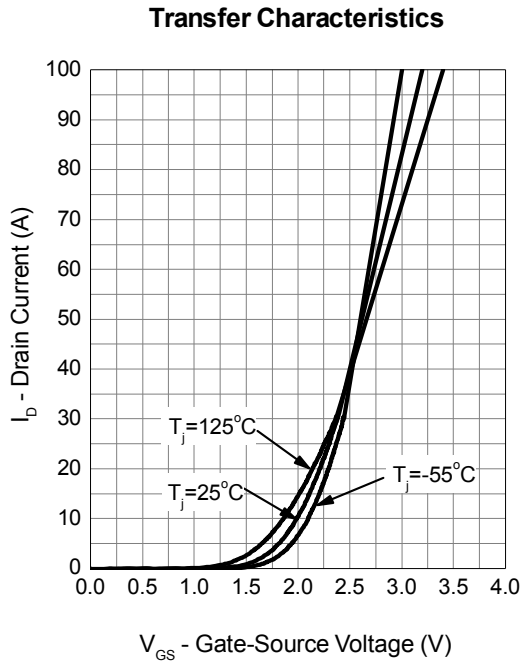



## Channel 2 Typical Operating Characteristics

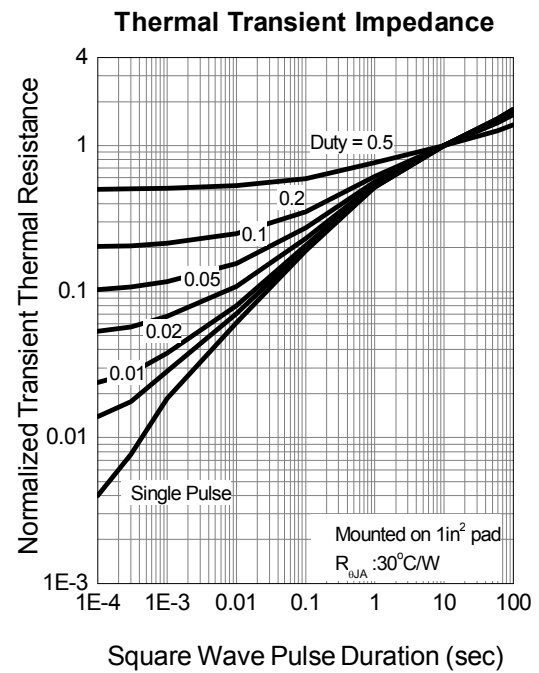
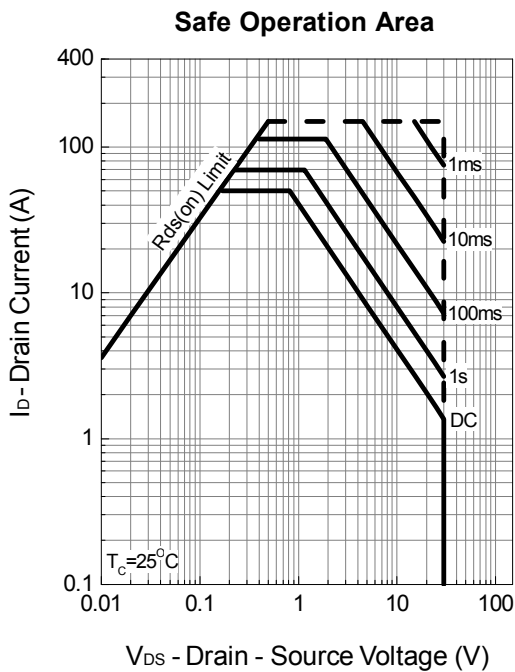
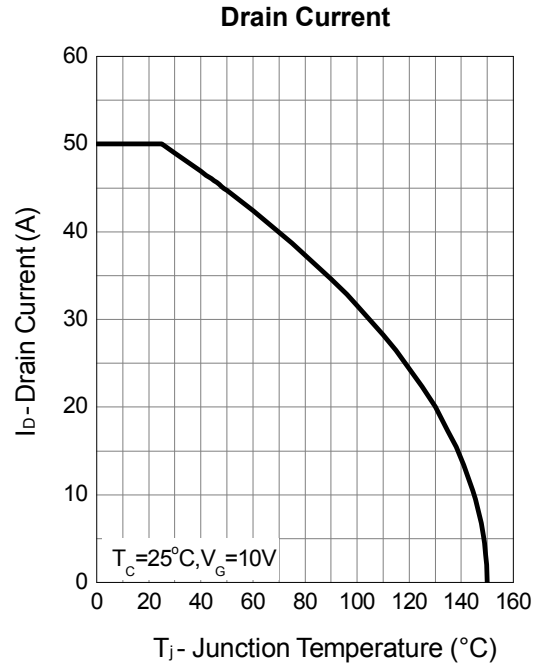
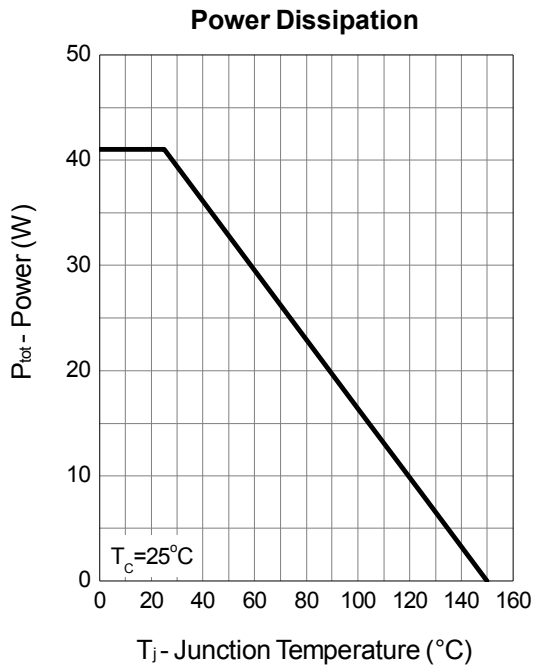

Channel 2 Typical Operating Characteristics (Cont.)

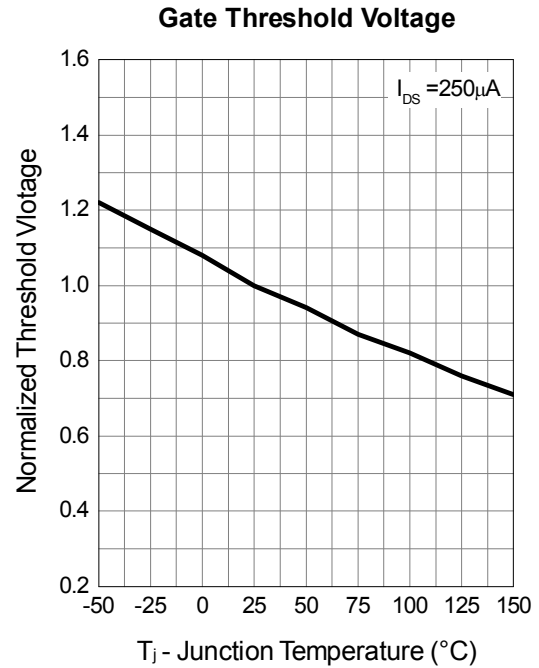
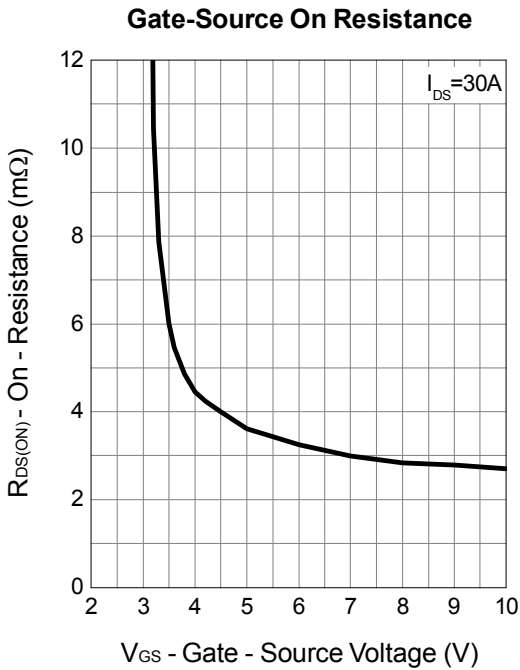
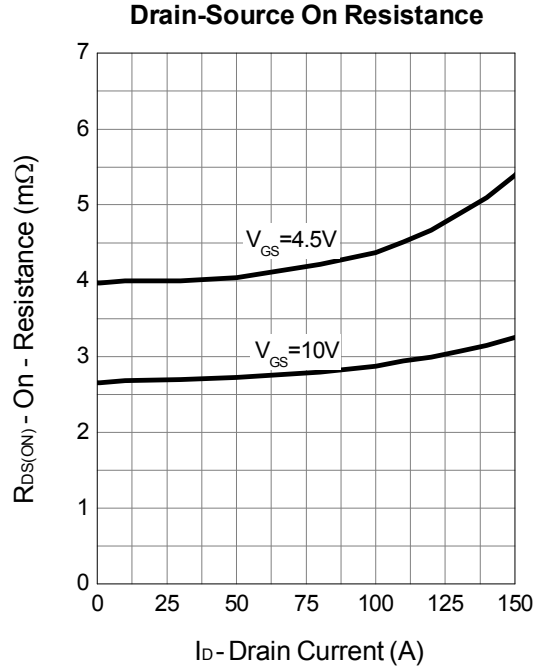
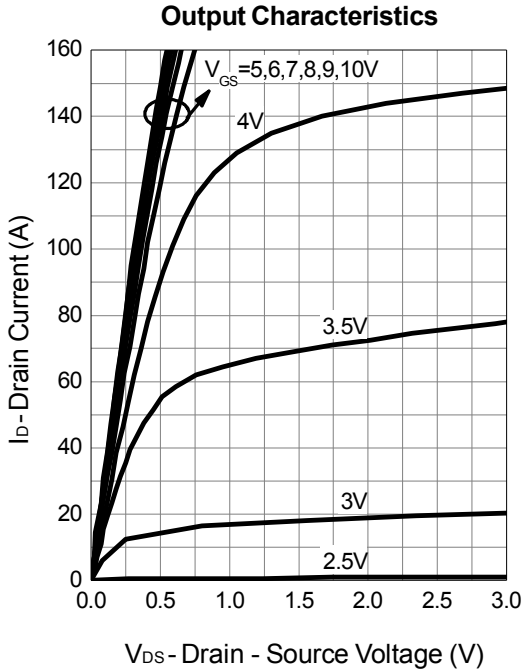

Channel 2 Typical Operating Characteristics (Cont.)

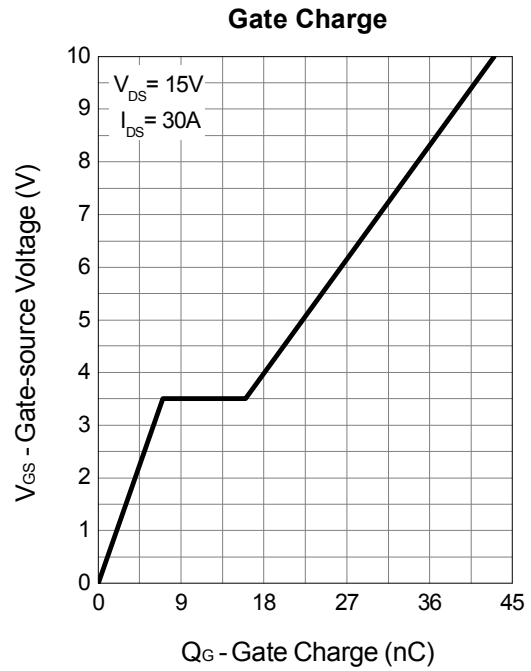
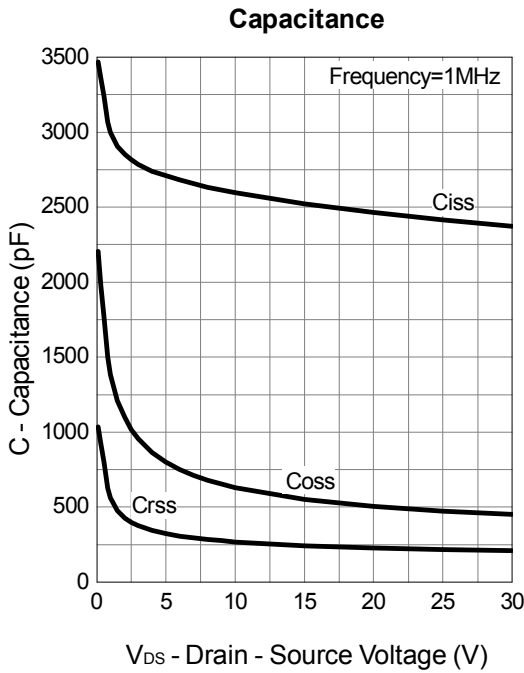
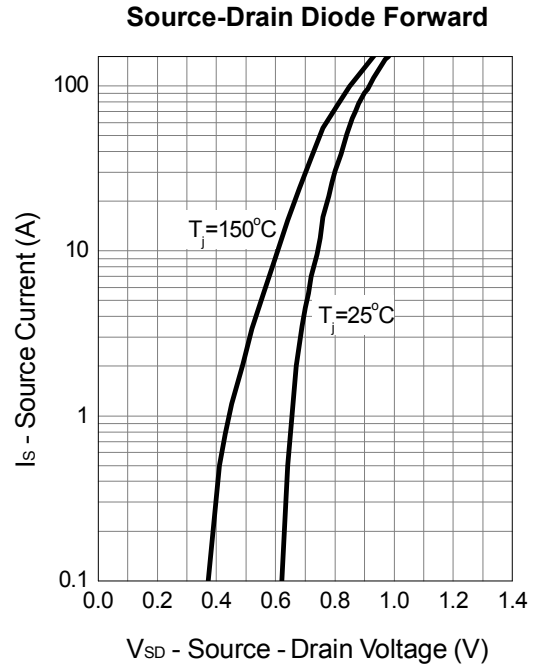
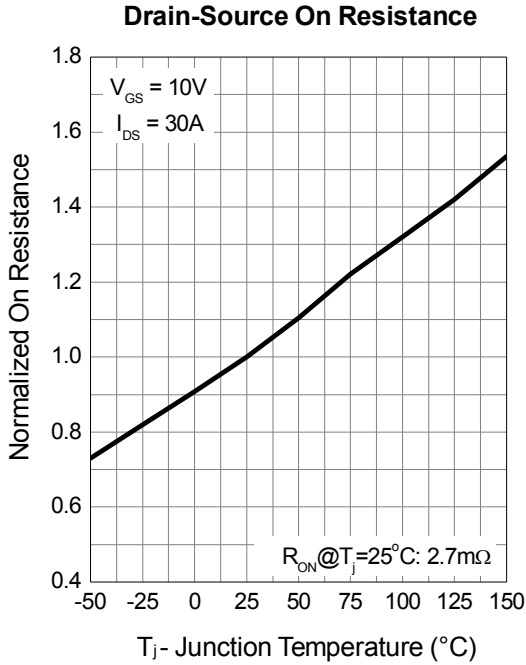

### Avalanche Test Circuit and Waveforms

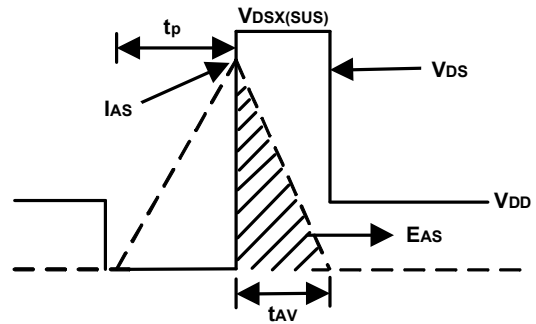
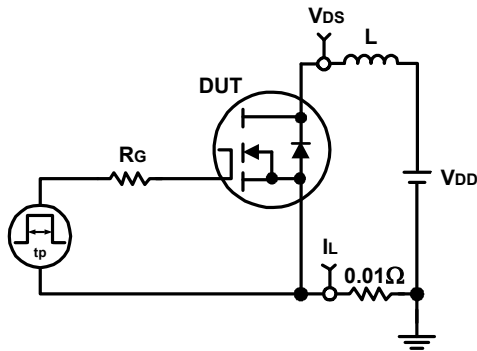

### Switching Time Test Circuit and Waveforms

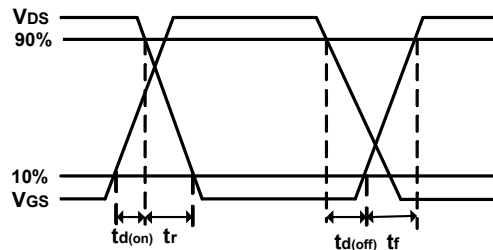
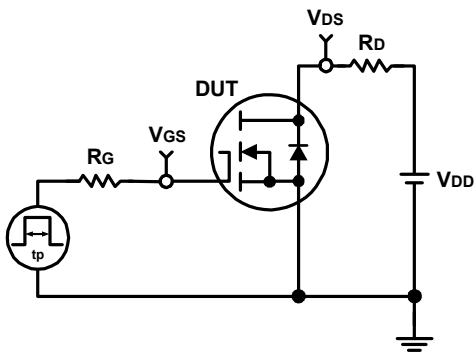

## Package Information

### DUAL DFN5x6-8

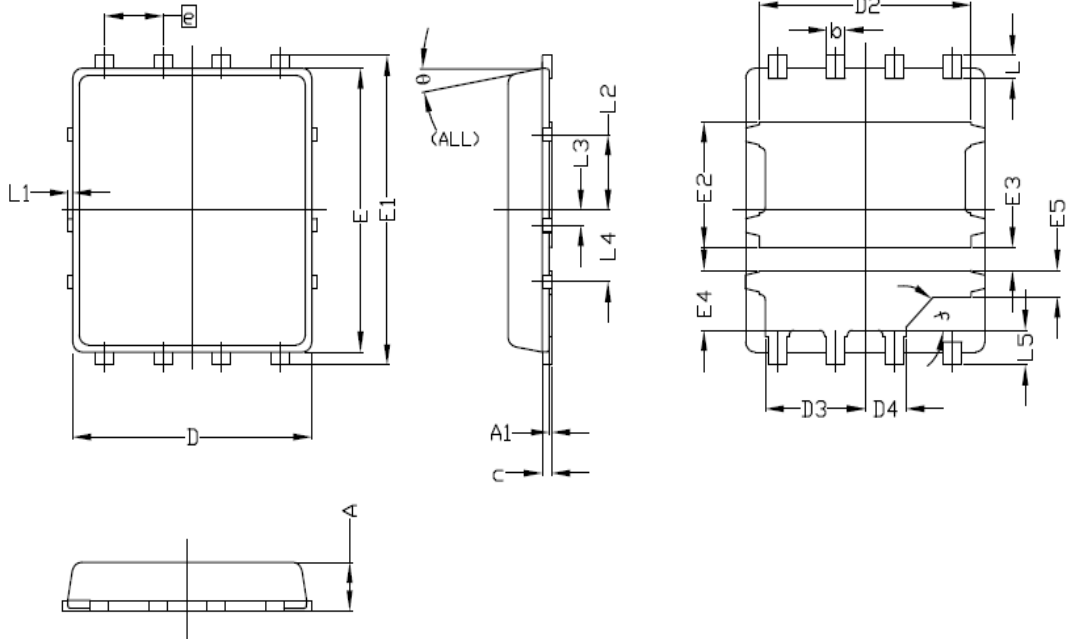

FORMER	DUAL DFN5x6-8			
	MILLIMETERS		INCHES	
	MIN.	MAX.	MIN.	MAX.
A	0.85	1.00	0.033	0.039
A1	0.00	0.05	0.000	0.002
b	0.35	0.45	0.014	0.018
c	0.15	0.25	0.006	0.010
D	5.20 BSC		0.205 BSC	
D2	4.50	4.70	0.177	0.185
D3	2.125	2.225	0.084	0.088
D4	0.835	0.935	0.033	0.037
E	5.55 BSC		0.219 BSC	
E1	6.05 BSC		0.238 BSC	
E2	2.40	2.50	0.094	0.098
E3	0.40	0.50	0.016	0.020
E4	1.125	1.225	0.044	0.048
E5	0.475	0.575	0.019	0.023
e	1.27 BSC		0.050 BSC	
L	0.35	0.55	0.014	0.022
L1	0.00	0.10	0.000	0.004
L2	1.375	1.575	0.054	0.062
L3	0.20	0.40	0.008	0.016
L4	1.30	1.50	0.051	0.059
L5	0.575	0.775	0.023	0.031
f	45°		45°	
θ	0°	10°	0°	10°

### RECOMMENDED LAND PATTERN

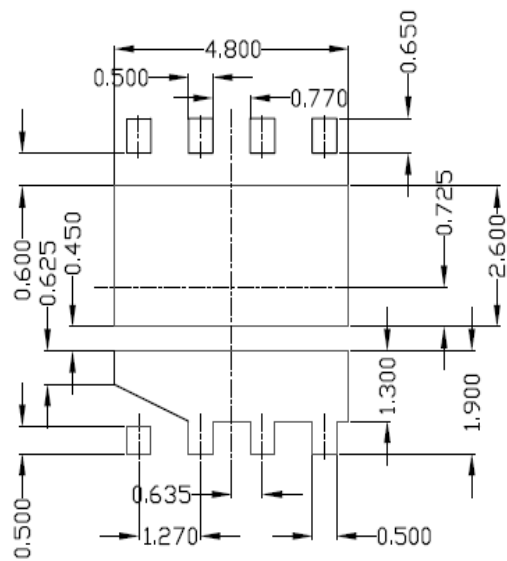

UNIT: mm

### Carrier Tape & Reel Dimensions

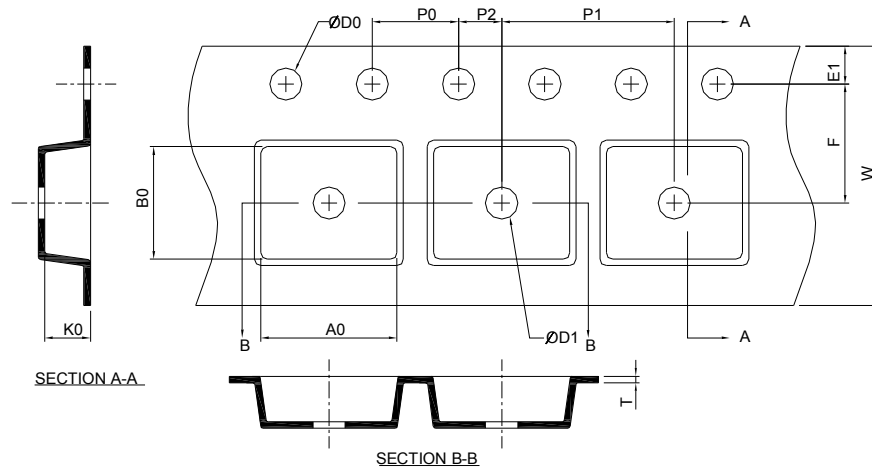

Application	A	H	T1	C	d	D	W	E1	F
DUAL DFN5x6-8	330.0±2.00	50 MIN.	12.4+2.00 -0.00	13.0+0.50 -0.20	1.5 MIN.	20.2 MIN.	12.0±0.30	1.75±0.10	5.5±0.10
	P0	P1	P2	D0	D1	T	A0	B0	K0
	4.0±0.10	8.0±0.10	2.0±0.10	1.5+0.10 -0.00	1.5 MIN.	0.3±0.05	6.5±0.10	5.3±0.10	1.4±0.10

(mm)

## Taping Direction Information

DUAL DFN5x6-8

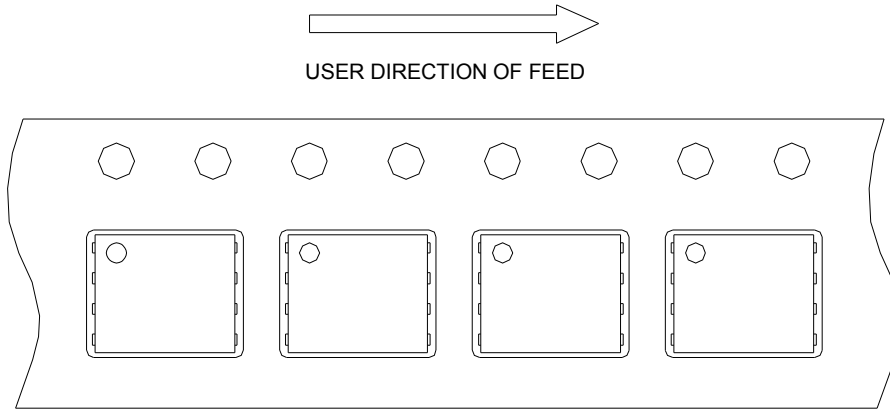

## Classification Profile

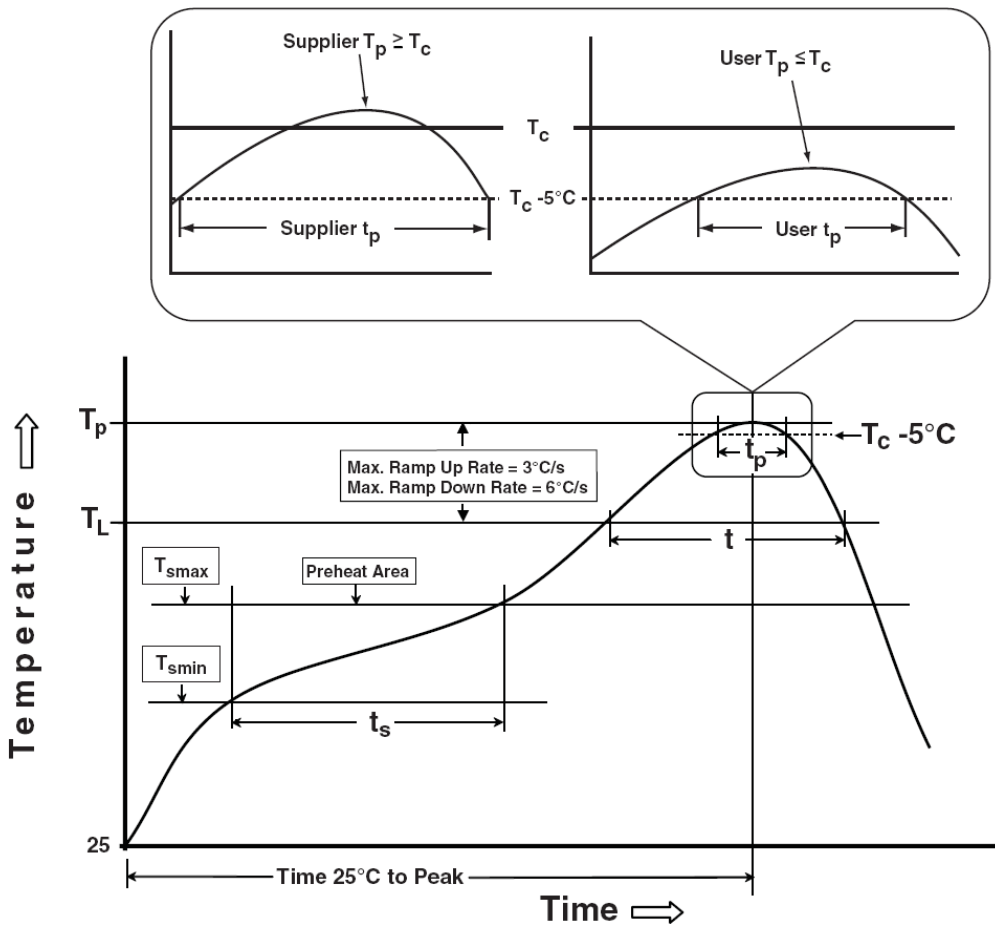

## Classification Reflow Profiles

Profile Feature	Sn-Pb Eutectic Assembly	Pb-Free Assembly
<b>Preheat &amp; Soak</b>		
Temperature min ( $T_{smin}$ )	100 °C	150 °C
Temperature max ( $T_{smax}$ )	150 °C	200 °C
Time ( $T_{smin}$ to $T_{smax}$ ) ( $t_s$ )	60-120 seconds	60-120 seconds
Average ramp-up rate ( $T_{smax}$ to $T_p$ )	3 °C/second max.	3°C/second max.
Liquidous temperature ( $T_L$ )	183 °C	217 °C
Time at liquidous ( $t_L$ )	60-150 seconds	60-150 seconds
Peak package body Temperature ( $T_p$ )*	See Classification Temp in table 1	See Classification Temp in table 2
Time ( $t_p$ )** within 5°C of the specified classification temperature ( $T_c$ )	20** seconds	30** seconds
Average ramp-down rate ( $T_p$ to $T_{smax}$ )	6 °C/second max.	6 °C/second max.
Time 25°C to peak temperature	6 minutes max.	8 minutes max.
* Tolerance for peak profile Temperature ( $T_p$ ) is defined as a supplier minimum and a user maximum.		
** Tolerance for time at peak profile temperature ( $t_p$ ) is defined as a supplier minimum and a user maximum.		

Table 1. SnPb Eutectic Process – Classification Temperatures ( $T_c$ )

Package Thickness	Volume mm <sup>3</sup> <350	Volume mm <sup>3</sup> ≥350
<2.5 mm	235 °C	220 °C
≥2.5 mm	220 °C	220 °C

Table 2. Pb-free Process – Classification Temperatures ( $T_c$ )

Package Thickness	Volume mm <sup>3</sup> <350	Volume mm <sup>3</sup> 350-2000	Volume mm <sup>3</sup> >2000
<1.6 mm	260 °C	260 °C	260 °C
1.6 mm – 2.5 mm	260 °C	250 °C	245 °C
≥2.5 mm	250 °C	245 °C	245 °C

## Reliability Test Program

Test item	Method	Description
SOLDERABILITY	JESD-22, B102	5 Sec, 245°C
HTRB	JESD-22, A108	1000 Hrs, 80% of VDS max @ $T_{jmax}$
HTGB	JESD-22, A108	1000 Hrs, 100% of VGS max @ $T_{jmax}$
PCT	JESD-22, A102	168 Hrs, 100%RH, 2atm, 121°C
TCT	JESD-22, A104	500 Cycles, -65°C~150°C

## Customer Service

### Sinopower Semiconductor, Inc.

5F, No. 6, Dusing 1St Rd., Hsinchu Science Park,

Hsinchu, 30078, Taiwan

TEL: 886-3-5635818 Fax: 886-3-5642050