

N-Channel Enhancement Mode MOSFET

## Features

- 800V/17A,  
 $R_{DS(ON)} = 0.31\Omega(\text{max.}) @ V_{GS} = 10V$   
 $V_{DS} @ T_j, \text{max} = 930V (\text{typ.})$
- Reliable and Rugged
- Avalanche Rated
- Lead Free and Green Devices Available  
 (RoHS Compliant)

## Applications

- AC/DC Power Conversion in Switched Mode Power Supplies (SMPS).
- Uninterruptible Power Supply (UPS),
- Adapter.

## Pin Description



Top View of TO-220

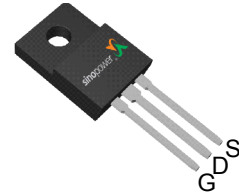

Top View of TO-220-FP

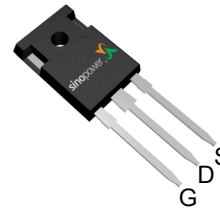

TO-247

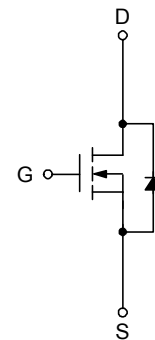

N-Channel MOSFET

## Ordering and Marking Information

<p>SM8A02NS <span style="font-family: monospace;">□□□-□□□</span></p> <div style="margin-left: 20px;"> <p>└─ Assembly Material</p> <p>└─ Handling Code</p> <p>└─ Temperature Range</p> <p>└─ Package Code</p> </div>	<p>Package Code                  F : TO-220    FP : TO-220-FP    W : TO-247</p> <p>Operating Junction Temperature Range                  C : -55 to 150 °C</p> <p>Handling Code                  TU : Tube (TO-220/TO-220FP, 50ea/tube)                  (TO-247, 30ea/tube)</p> <p>Assembly Material                  G : Halogen and Lead Free Device</p>
<p>SM8A02NS F/FP/W : </p>	<p>XXXXX - Lot Code</p>

Note: SINOPOWER lead-free products contain molding compounds/die attach materials and 100% matte tin plate termination finish; which are fully compliant with RoHS. SINOPOWER lead-free products meet or exceed the lead-free requirements of IPC/JEDEC J-STD-020D for MSL classification at lead-free peak reflow temperature. SINOPOWER defines "Green" to mean lead-free (RoHS compliant) and halogen free (Br or Cl does not exceed 900ppm by weight in homogeneous material and total of Br and Cl does not exceed 1500ppm by weight).

SINOPOWER reserves the right to make changes to improve reliability or manufacturability without notice, and advise customers to obtain the latest version of relevant information to verify before placing orders.

## Absolute Maximum Ratings

Symbol	Parameter	Rating	Unit
<b>Common Ratings</b> ( $T_A=25^\circ\text{C}$ Unless Otherwise Noted)			
$V_{DSS}$	Drain-Source Voltage	800	V
$V_{GSS}$	Gate-Source Voltage	$\pm 30$	
$T_J$	Maximum Junction Temperature	150	$^\circ\text{C}$
$T_{STG}$	Storage Temperature Range	-55 to 150	
$I_S$	Diode Continuous Forward Current	17 <sup>a</sup>	A
$I_{DP}$	300 $\mu\text{s}$ Pulse Drain Current Tested	$T_C=25^\circ\text{C}$ 35 <sup>a</sup>	
$I_D$	Continuous Drain Current	$T_C=25^\circ\text{C}$ 17 <sup>a</sup>	
		$T_C=100^\circ\text{C}$ 11 <sup>a</sup>	
$P_D$	Maximum Power Dissipation for TO-220/TO-247	$T_C=25^\circ\text{C}$ 277	W
		$T_C=100^\circ\text{C}$ 111	
$P_D$	Maximum Power Dissipation for TO-220FP	$T_C=25^\circ\text{C}$ 41	
		$T_C=100^\circ\text{C}$ 16	
$R_{\theta JC}$	Thermal Resistance-Junction to Case for TO-220/TO-247	0.45	$^\circ\text{C/W}$
$R_{\theta JC}$	Thermal Resistance-Junction to Case for TO-220FP	3	
$R_{\theta JA}$	Thermal Resistance-Junction to Ambient	62.5	
<b>Drain-Source Avalanche Ratings</b>			
$dv/dt^b$	MOSFET $dv/dt$ ruggedness	50	V/ns
$E_{AS}^c$	Avalanche Energy, Single Pulsed	490	mJ
$I_{AR}^d$	Avalanche Current	3.5	A
$E_{AR}^d$	Repetitive Avalanche Energy	0.9	mJ

Note a : limited by maximum junction temperature.

Note b :  $V_{DS}=640\text{V}$ ,  $I_D=17\text{A}$ .

Note c :  $I_D=3.5\text{A}$ ,  $V_{DD}=50\text{V}$ ,  $T_J=25^\circ\text{C}$ .

Note d : Repetitive Rating : Pulse width limited by maximum junction temperature.

**Electrical Characteristics** ( $T_A = 25^\circ\text{C}$  Unless Otherwise Noted)

Symbol	Parameter	Test Conditions	Min.	Typ.	Max.	Unit
<b>Static Characteristics</b>						
$BV_{DSS}$	Drain-Source Breakdown Voltage	$V_{GS}=0V, I_{DS}=250\mu A$	800	-	-	V
		$T_J=150^\circ\text{C}$	-	930	-	
$I_{DSS}$	Zero Gate Voltage Drain Current	$V_{DS}=640V, V_{GS}=0V$	-	-	1	$\mu A$
		$T_J=150^\circ\text{C}$	-	-	200	
$V_{GS(th)}$	Gate Threshold Voltage	$V_{DS}=V_{GS}, I_{DS}=250\mu A$	2.5	3.5	4.5	V
$I_{GSS}$	Gate Leakage Current	$V_{GS}=\pm 30V, V_{DS}=0V$	-	-	$\pm 100$	nA
$R_{DS(ON)}^e$	Drain-Source On-state Resistance	$V_{GS}=10V, I_{DS}=10A$	-	0.27	0.31	$\Omega$
<b>Diode Characteristics</b>						
$V_{SD}^e$	Diode Forward Voltage	$I_{SD}=17A, V_{GS}=0V$	-	0.85	1.3	V
$t_{rr}$	Reverse Recovery Time	$I_{SD}=17A, V_R=480V$ $di_{SD}/dt=100A/\mu s$	-	480	-	ns
$Q_{rr}$	Reverse Recovery Charge		-	10.7	-	$\mu C$
$I_{rm}$	Peak Reverse Recovery Current		-	46	-	A
<b>Dynamic Characteristics<sup>f</sup></b>						
$R_G$	Gate Resistance	$V_{GS}=0V, V_{DS}=0V,$ $F=1\text{MHz}$	-	1.4	-	$\Omega$
$C_{iss}$	Input Capacitance	$V_{GS}=0V,$ $V_{DS}=25V,$ Frequency=1.0MHz	-	2400	3120	pF
$C_{oss}$	Output Capacitance		-	865	-	
$C_{riss}$	Reverse Transfer Capacitance		-	55	-	
$t_{d(ON)}$	Turn-on Delay Time	$V_{DD}=400V, R_L=30\Omega,$ $I_{DS}=17A, V_{GEN}=10V,$ $R_G=6\Omega$	-	20	-	ns
$T_r$	Turn-on Rise Time		-	44	-	
$t_{d(OFF)}$	Turn-off Delay Time		-	43	-	
$T_f$	Turn-off Fall Time		-	26	-	
<b>Gate Charge Characteristics<sup>f</sup></b>						
$Q_g$	Total Gate Charge	$V_{DS}=640V, V_{GS}=10V,$ $I_{DS}=17A$	-	60	80	nC
$Q_{gs}$	Gate-Source Charge		-	15	-	
$Q_{gd}$	Gate-Drain Charge		-	27	-	

Note e : Pulse test ; pulse width $\leq 300\mu s$ , duty cycle $\leq 2\%$ .

Note f : Guaranteed by design, not subject to production testing.

## Typical Operating Characteristics

Power Dissipation : TO-220/TO-247

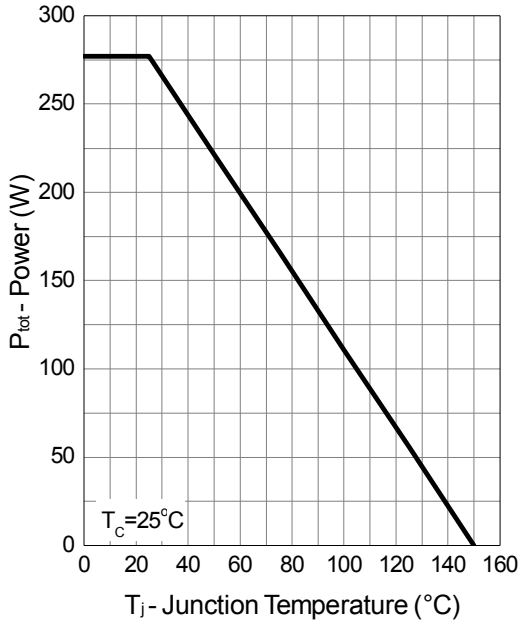

Power Dissipation : TO-220FP

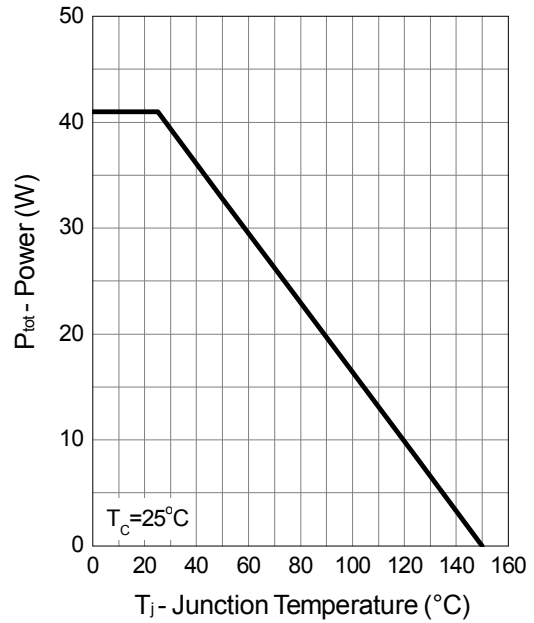

Safe Operation Area : TO-220/TO-247

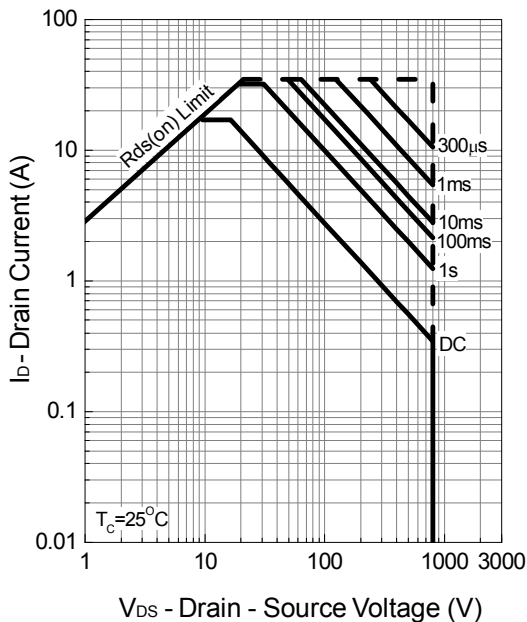

Safe Operation Area : TO-220FP

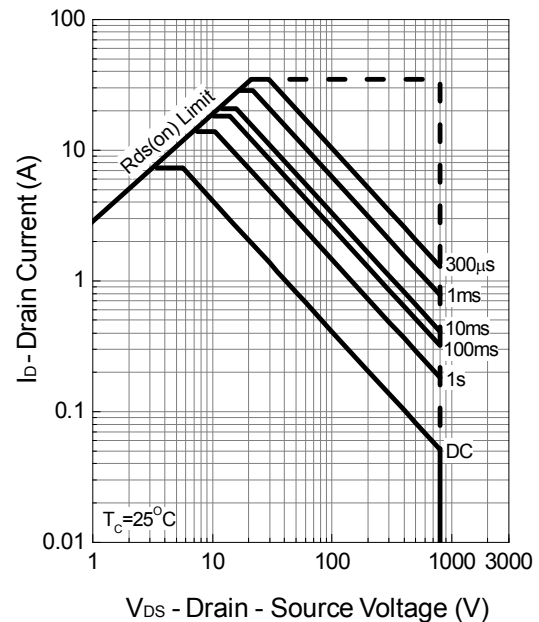

Typical Operating Characteristics (Cont.)

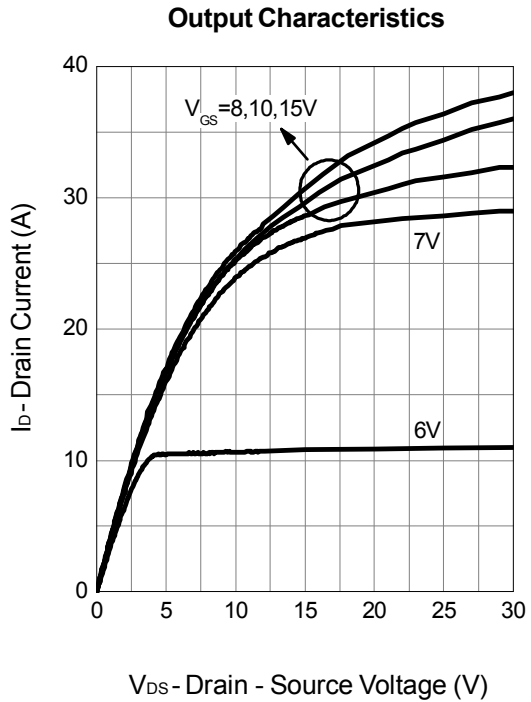
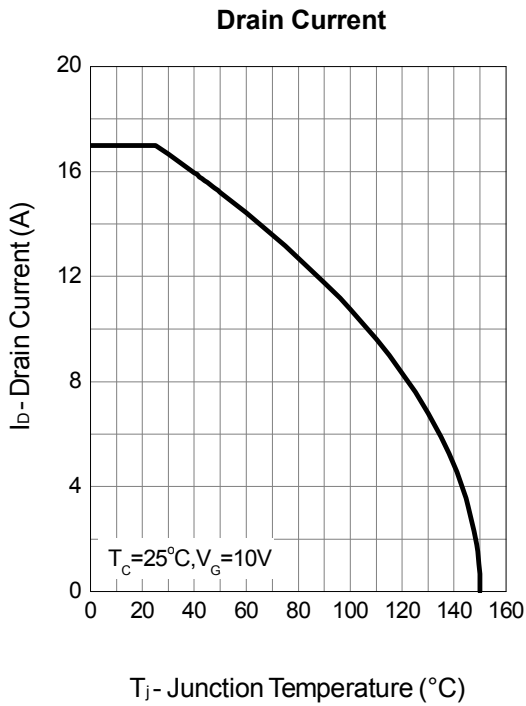
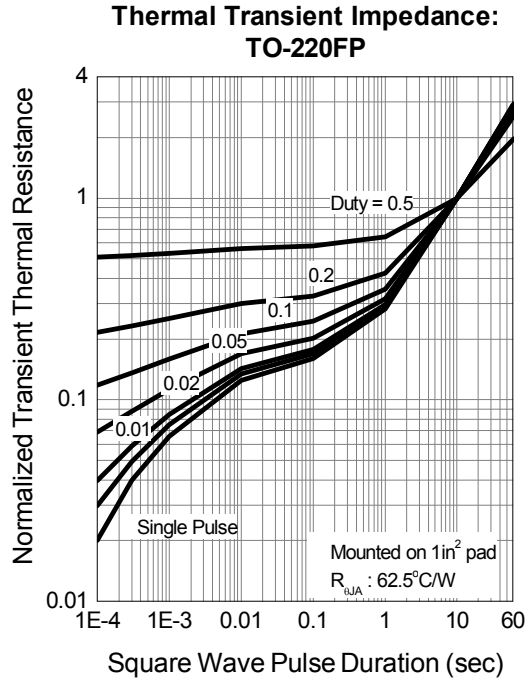
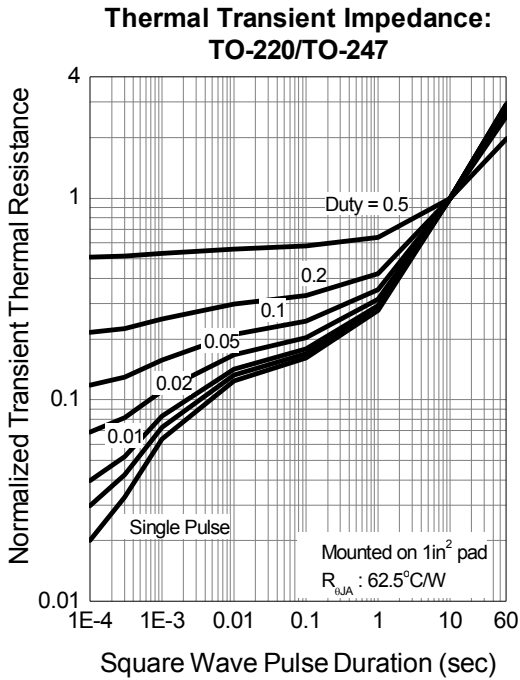

**Typical Operating Characteristics (Cont.)**

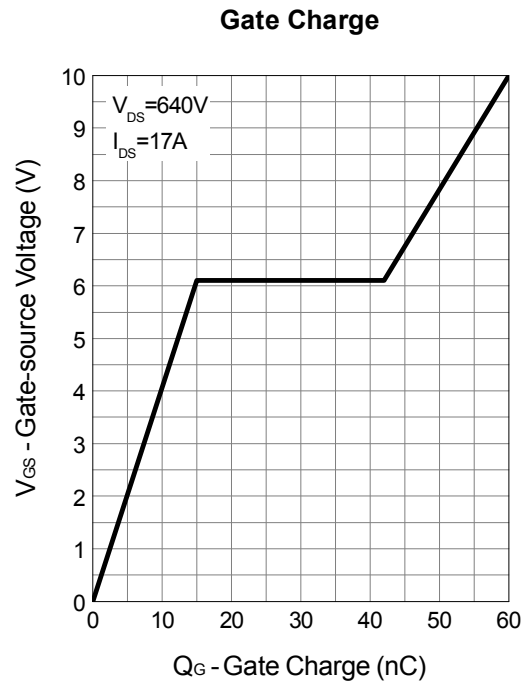
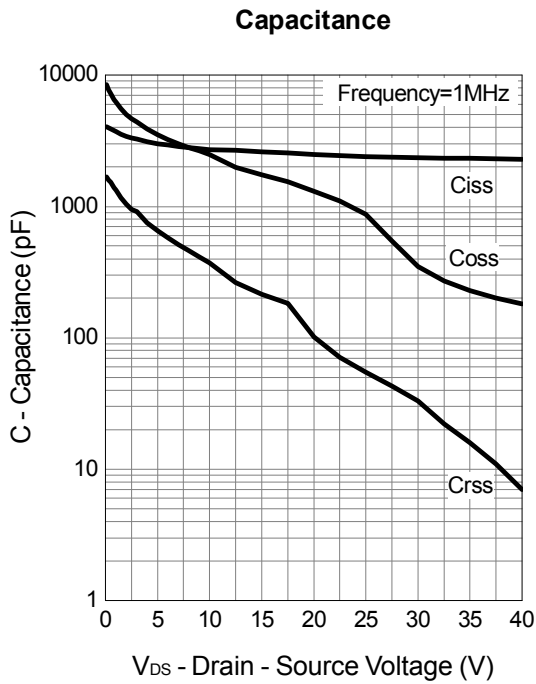
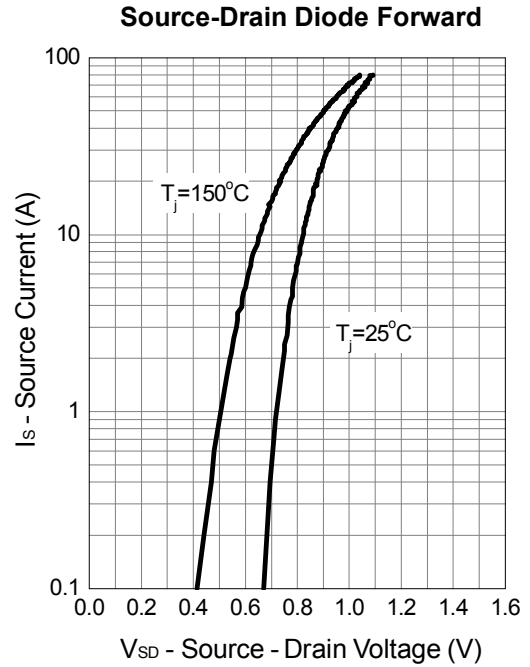
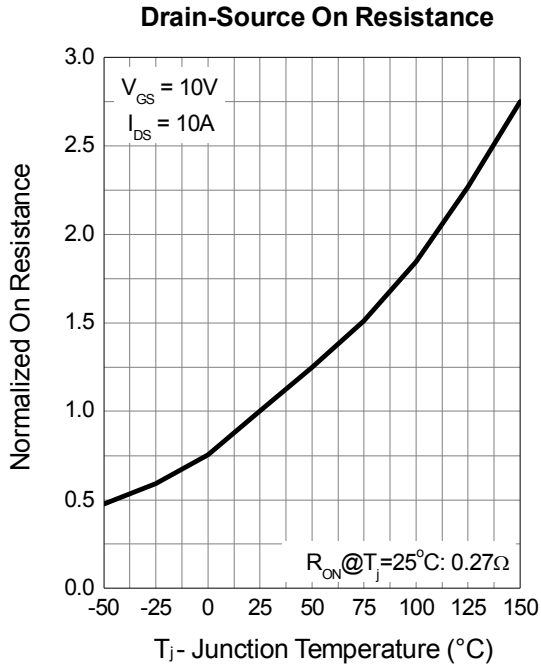

## Typical Operating Characteristics (Cont.)

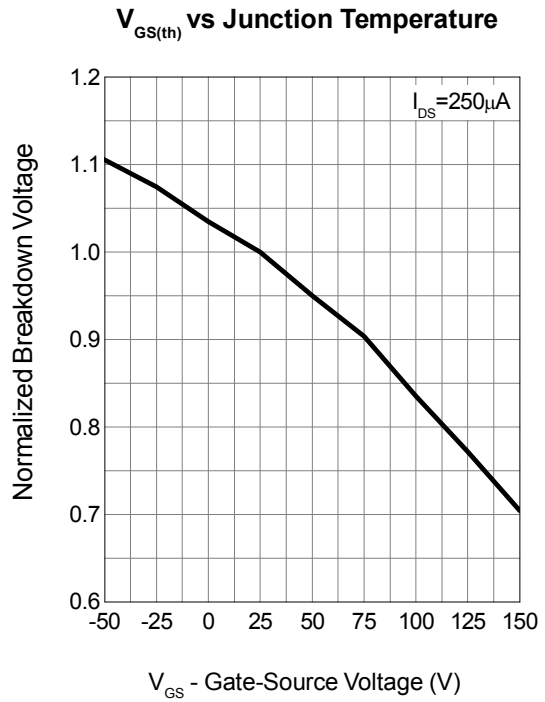
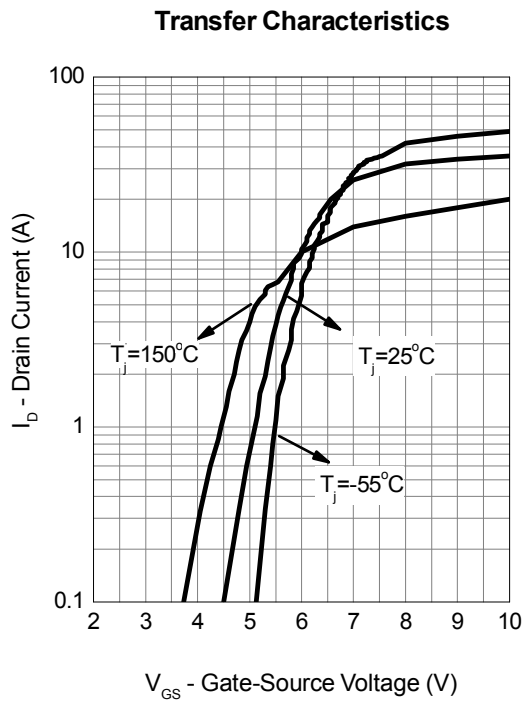
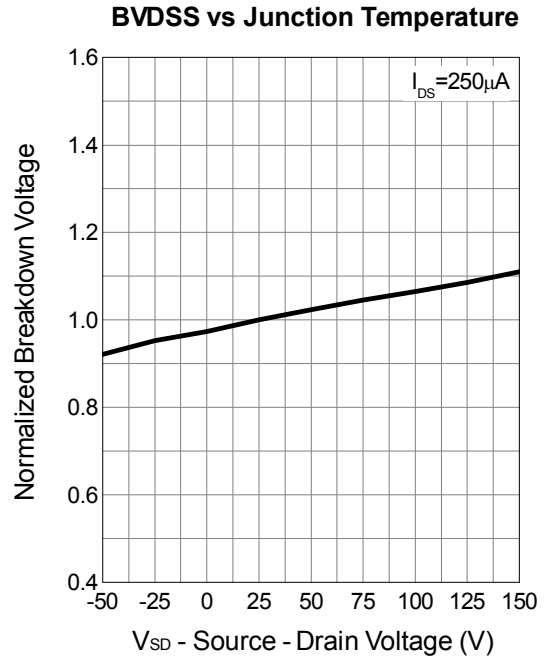
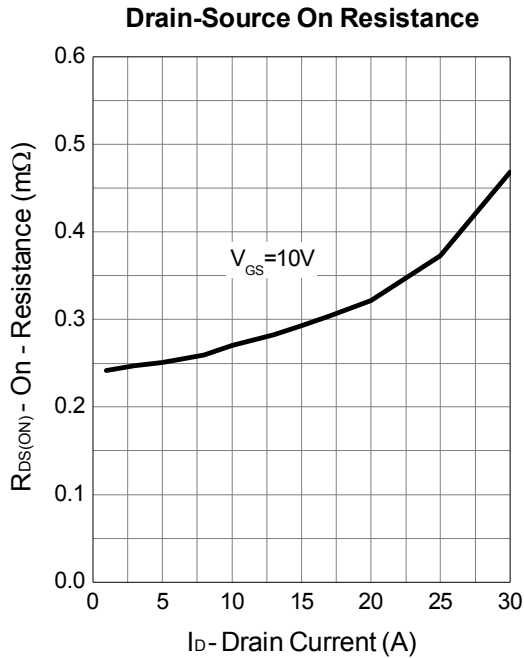

## Avalanche Test Circuit and Waveforms

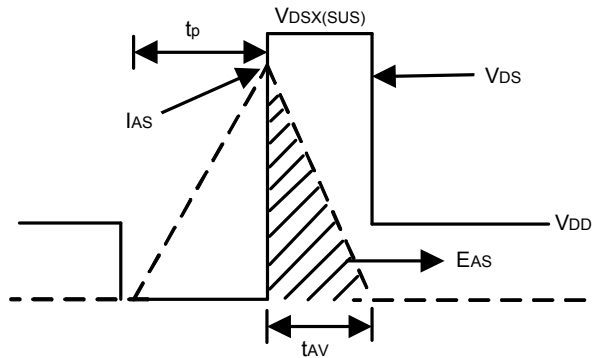
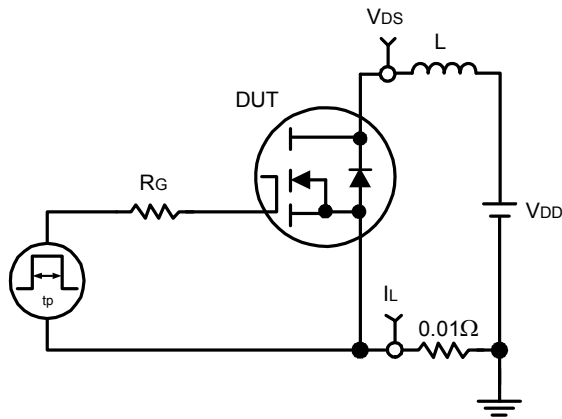

## Switching Time Test Circuit and Waveforms

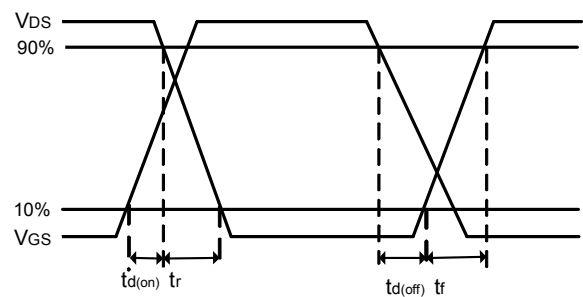
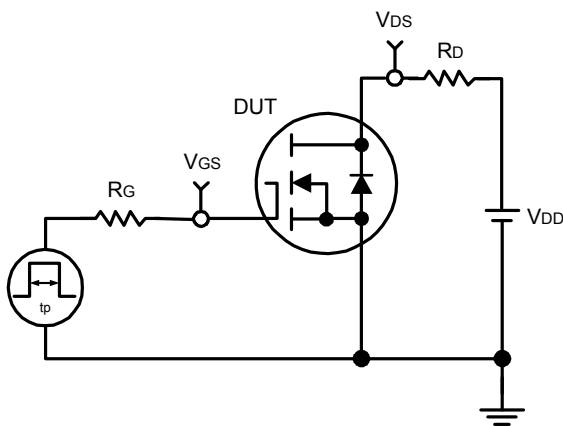



## Package Information

TO-220

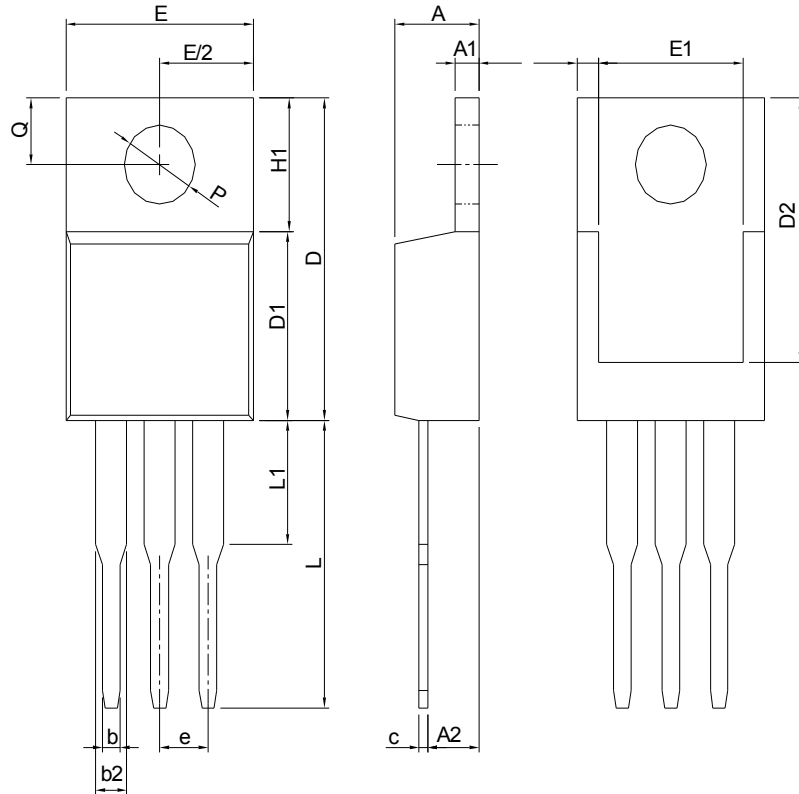

SYMBOL	TO-220			
	MILLIMETERS		INCHES	
	MIN.	MAX.	MIN.	MAX.
A	3.56	4.83	0.140	0.190
A1	0.51	1.40	0.020	0.055
A2	2.03	2.92	0.080	0.115
b	0.38	1.02	0.015	0.040
b2	1.14	1.78	0.045	0.070
c	0.36	0.61	0.014	0.024
D	14.22	16.51	0.560	0.650
D1	8.38	9.02	0.330	0.355
D2	12.19	13.65	0.480	0.537
E	9.65	10.67	0.380	0.420
E1	6.86	8.89	0.270	0.350
e	2.54 BSC		0.100 BSC	
H1	5.84	6.86	0.230	0.270
L	12.70	14.73	0.500	0.580
L1	-	6.35	-	0.250
P	3.53	4.09	0.139	0.161
Q	2.54	3.43	0.100	0.135

### RECOMMENDED LAND PATTERN

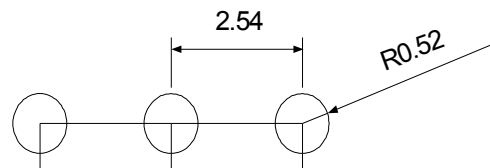

UNIT: mm

Note: Follow JEDEC TO-220 AB.

## Package Information

TO-220-FP

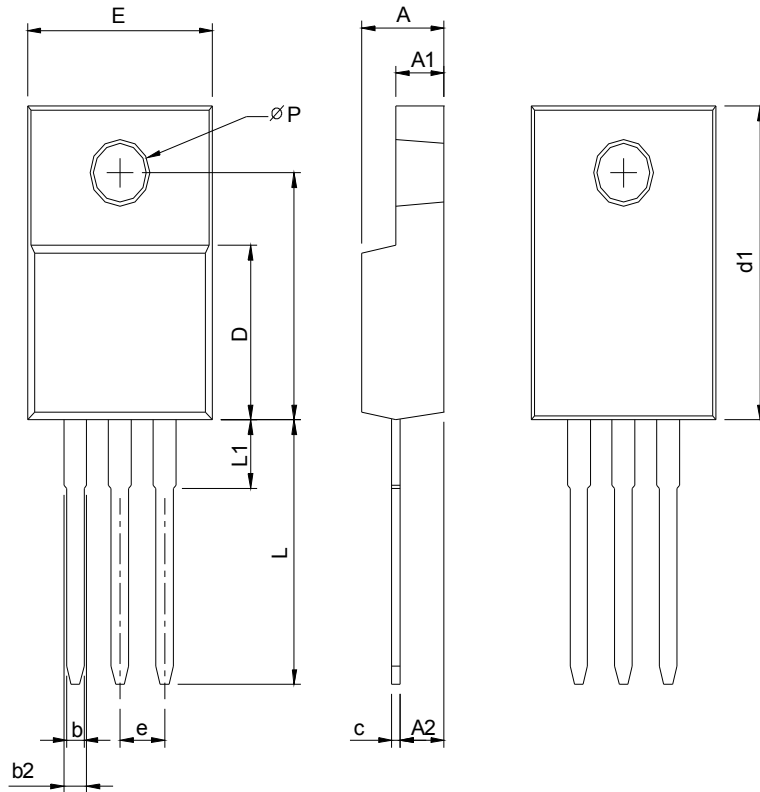

SYMBOL	TO-220FP			
	MILLIMETERS		INCHES	
	MIN.	MAX.	MIN.	MAX.
A	4.20	4.80	0.165	0.189
A1	2.60	3.20	0.102	0.126
A2	2.10	2.90	0.083	0.114
b	0.50	1.00	0.020	0.039
b2	0.90	1.90	0.035	0.075
c	0.30	0.80	0.012	0.031
D	8.10	9.10	0.319	0.358
d1	14.50	16.50	0.571	0.650
d2	12.10	12.90	0.476	0.508
E	9.70	10.70	0.382	0.421
e	2.54 BSC		0.100 BSC	
L	13.00	14.50	0.512	0.570
L1	1.60	4.00	0.063	0.157
P	3.00	3.60	0.118	0.142

### RECOMMENDED LAND PATTERN

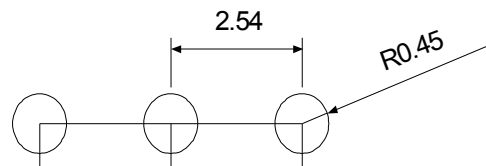

UNIT: mm

## Package Information

TO-247

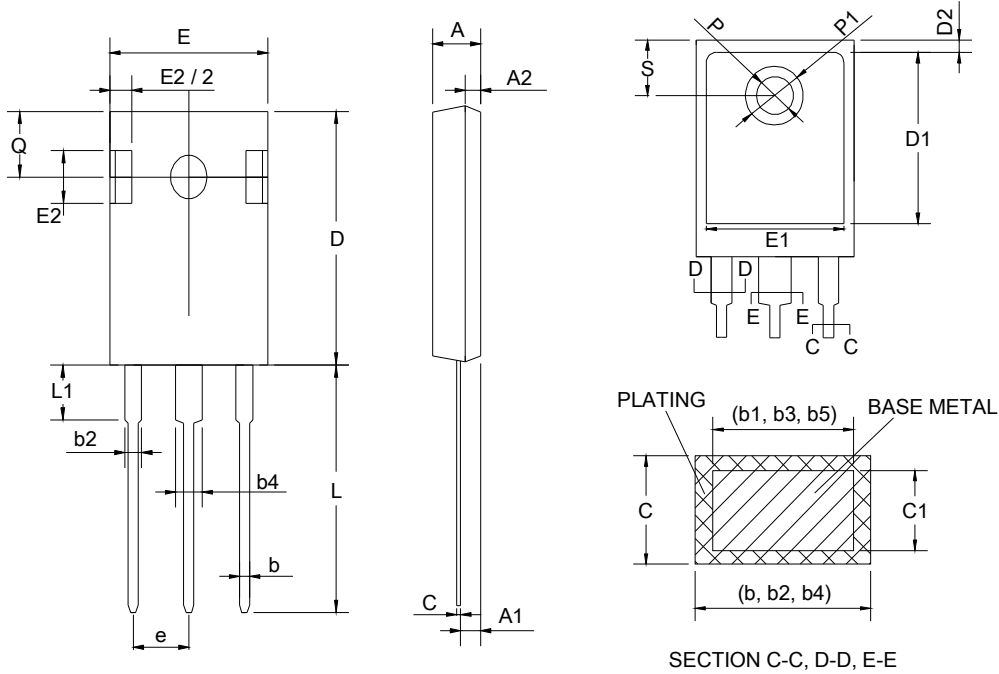

DIMENSIONS	TO-247			
	MILLIMETERS		INCHES	
	MIN.	MAX.	MIN.	MAX.
A	4.7	5.31	0.185	0.209
A1	2.21	2.59	0.087	0.102
A2	1.5	2.49	0.059	0.098
D	20.8	21.46	0.819	0.845
E	15.49	16.26	0.610	0.640
E2	4.32	5.49	0.170	0.216
e	5.46 BSC		0.215 BSC	
L	19.81	20.32	0.780	0.800
L1	-	4.5	-	0.177
P	3.56	3.66	0.140	0.144
Q	5.38	6.2	0.212	0.244
S	6.15 BSC		0.242 BSC	
b	0.99	1.4	0.039	0.055
b1	0.99	1.35	0.039	0.053
b2	1.65	2.39	0.065	0.094
b3	1.65	2.34	0.065	0.092
b4	2.59	3.43	0.102	0.135
b5	2.59	3.38	0.102	0.133
c	0.38	0.89	0.015	0.035
c1	0.38	0.84	0.015	0.033
D1	13.08	-	0.515	-
D2	0.51	1.35	0.020	0.053
E1	13.46	-	0.530	-
P1	-	7.4	-	0.291

### RECOMMENDED LAND PATTERN

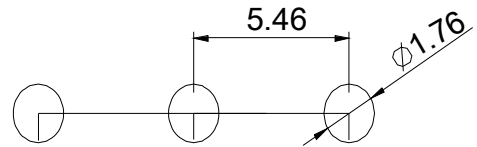

UNIT: mm

### Classification Profile

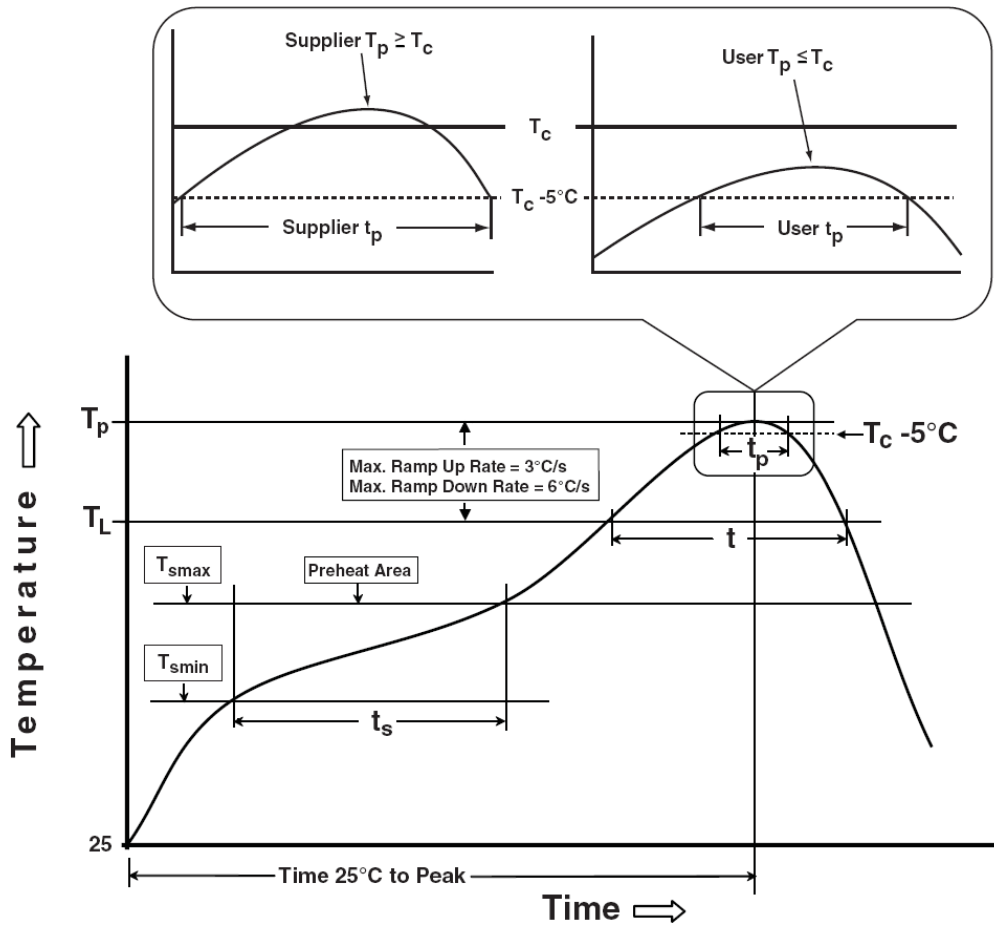

## Classification Reflow Profiles

Profile Feature	Sn-Pb Eutectic Assembly	Pb-Free Assembly
<b>Preheat &amp; Soak</b>		
Temperature min ( $T_{smin}$ )	100 °C	150 °C
Temperature max ( $T_{smax}$ )	150 °C	200 °C
Time ( $T_{smin}$ to $T_{smax}$ ) ( $t_s$ )	60-120 seconds	60-120 seconds
Average ramp-up rate ( $T_{smax}$ to $T_p$ )	3 °C/second max.	3°C/second max.
Liquidous temperature ( $T_L$ )	183 °C	217 °C
Time at liquidous ( $t_L$ )	60-150 seconds	60-150 seconds
Peak package body Temperature ( $T_p$ )*	See Classification Temp in table 1	See Classification Temp in table 2
Time ( $t_p$ )** within 5°C of the specified classification temperature ( $T_c$ )	20** seconds	30** seconds
Average ramp-down rate ( $T_p$ to $T_{smax}$ )	6 °C/second max.	6 °C/second max.
Time 25°C to peak temperature	6 minutes max.	8 minutes max.
* Tolerance for peak profile Temperature ( $T_p$ ) is defined as a supplier minimum and a user maximum. ** Tolerance for time at peak profile temperature ( $t_p$ ) is defined as a supplier minimum and a user maximum.		

Table 1. SnPb Eutectic Process – Classification Temperatures ( $T_c$ )

Package Thickness	Volume mm <sup>3</sup> <350	Volume mm <sup>3</sup> ≥350
<2.5 mm	235 °C	220 °C
≥2.5 mm	220 °C	220 °C

Table 2. Pb-free Process – Classification Temperatures ( $T_c$ )

Package Thickness	Volume mm <sup>3</sup> <350	Volume mm <sup>3</sup> 350-2000	Volume mm <sup>3</sup> >2000
<1.6 mm	260 °C	260 °C	260 °C
1.6 mm – 2.5 mm	260 °C	250 °C	245 °C
≥2.5 mm	250 °C	245 °C	245 °C

## Reliability Test Program

Test item	Method	Description
SOLDERABILITY	JESD-22, B102	5 Sec, 245°C
HTRB	JESD-22, A108	1000 Hrs, 80% of VDS max @ $T_{jmax}$
HTGB	JESD-22, A108	1000 Hrs, 100% of VGS max @ $T_{jmax}$
PCT	JESD-22, A102	168 Hrs, 100%RH, 2atm, 121°C
TCT	JESD-22, A104	500 Cycles, -65°C~150°C

## Customer Service

### Sinopower Semiconductor, Inc.

5F, No. 6, Dusing 1St Rd., Hsinchu Science Park,

Hsinchu, 30078, Taiwan

TEL: 886-3-5635818 Fax: 886-3-5642050