



PolySwitch自复式元件 表面贴装元件

从最初推出至今超过十五年，PolySwitch SMD 系列已经成为电脑、消费电子、多媒体、便携产品和汽车电子的首选电路保护方法。

1995年，我们改进了技术并推出了小尺寸和低成本的miniSMD产品系列。稍后又有了microSMD、nanoSMD和picoSMD产品系列的诞生，其中picoSMD系列将占板面积尺寸减小到2012mm (0805mils)，是普通miniSMD系列尺寸的四分之一。

最近增加的表面贴装的元件包括有24V的miniSMD4532mm (1812mils)，60V的decaSMD5050mm (2018mils)和2.0 A的microSMD 3225mm (1210mils)系列。



优点

- 体积小，节省PC板上空间和成本
- 多种产品选择给工程师更多的设计灵活性
- 可满足高量产电子产品装配
- 有助于满足行业要求
- 更高的额定电压可在新应用中使用

特性

- 符合RoHS标准
- 产品种类齐全能广泛应用于工业
- 额定电流0.05到3A
- 额定电压从6V的计算机和电子应用到60V的通讯应用
- 安规认证：UL, CSA, TÜV
- 占板面积小
- 快速断开时间
- 低阻抗

应用

- | | | |
|---------|-----------|--------|
| • 电脑 | • 游戏机 | • 汽车电子 |
| • 便携式电子 | • 电话和宽频系统 | • 工业控制 |
| • 多媒体 | • 手机 | • 电池组 |

保护应用选择表

- 以下指南列出了PolySwitch和SiBar元件的典型应用
- 推荐的元件型号规格可以在本节中找到
- 一旦选择了元件型号，用户应该针对其计划的应用评估和测试每一个产品

PolySwitch Resettable Devices - Key Selection Criteria

保护应用	附加说明	Overcurrent Overvoltage	Small Size	Low Resistance	FastTime-to-trip (Temperature Protection)
AC适配器输入电源	带齐纳管和可控硅开关		SMD250F	SMD250F	SMD200F
电池组保护			nanoSMDC150F	miniSMDC260F	miniSMDE190F
充电器保护			nanoSMDC050F	miniSMDC110F/16	nanoSMDC075F
CPU/IC保护			nanoSMDC110F	nanoSMDC150F	nanoSMDC075F
数据采集/传感器			microSMD005F	—	microSMD005F
DC 输入/输出电源	≤ 6V		nanoSMDC075F	nanoSMDC150F	nanoSMDC050F/13.2
	≤ 12V		miniSMDC075F	miniSMDC110F/16	miniSMDC075F
DDC			nanoSMDC075F	nanoSMDC110F	nanoSMDC050F/13.2
设备机架系统	DB12, DB20		miniSMDC200F	miniSMDC260F	miniSMDC200F
	DB32		miniSMDC260F	SMD300F	miniSMDC200F
以太网/Lan			nanoSMDC050F/13.2	miniSMDC110F/16	nanoSMDC075F
风扇			microSMD035F	microSMD050F	microSMD035F
HDMI			picoSMD035F	picoSMD035F	picoSMD035F
IEEE 802.3af	VOIP		decaSMDC050F/60	decaSMDC050F/60	decaSMDC050F/60
IEEE-1394	电源提供		SMD100F/33	SMD185F	SMD100F/33
	alt. power provider		SMD185F	SMD185F	SMD150F/33
	自带电源		SMD185F	SMD185F	SMD150F/33
LCD转换器			nanoSMDC050F/13.2	miniSMDC110F/16	nanoSMDC075F
LCD显示器电源			nanoSMDC050F/13.2	nanoSMDC050F/13.2	microSMD035F
LNB (低噪声模块)			SMD075F	SMD075F	SMD050F
马达	≤ 6V		nanoSMDC110F	nanoSMDC150F	microSMD075F
	≤ 13.2V		miniSMDC075F	miniSMDC110F/16	miniSMDC075F
PS/2鼠标/键盘			nanoSMDC075F	nanoSMDC110F	nanoSMDC050F/13.2
信号—数据通信	≤ 6V		nanoSMDC075F	nanoSMDC075F	nanoSMDC075F
	≤ 13.2V		miniSMDC050F	miniSMDC075F	miniSMDC020F
	≤ 30V		SMD030F-2018	SMD075F	SMD050F
SCSI			nanoSMDC110F	nanoSMDC150F	nanoSMDC075F
智能卡读卡器			microSMD010F	microSMD035F	microSMD005F
电信—调制解调器	数字线路	OC	miniSMDC014F	miniSMDC014F	miniSMDC014F
		OV	TVBxxx(N/M/R)SC-L*	TVBxxx(N/M/R)SC-L*	TVBxxx(N/M/R)SC-L*
电信—PBX	用户端	OC	miniSMDC014F	miniSMDC014F	miniSMDC014F
温度传感器	CPU		nanoSMDC050F/13.2	nanoSMDC075F	nanoSMDC050F/13.2
USB	独立端口		nanoSMDC075F	nanoSMDC110F	nanoSMDC050F/13.2
	2端口组		nanoSMDC150F	miniSMDC150F	miniSMDC125F
	3端口组		miniSMDC200F	miniSMDC200F	miniSMDC200F



注意：这张表并不完整。泰科电子欢迎用户对PolySwitch自复式元件提出更多的应用想法。

* 更多信息请参考第37页SiBar浪涌保护产品一节。

表 S1 产品尺寸, 额定电流, 额定电压及最大电阻值

	picoSMD	nanoSMD	microSMD	miniSMD	midSMD	SMD	SMD2	miniSMDE	decaSMD
尺寸mm(mils)	2012 (0805)	3216 (1206)	3225 (1210)	4532 (1812)	5050 (2018)	7555 (2920)	8763 (3425)	11550 (4420)	5050 (2018)
保持电流(A)	-	-	-	-	-	-	-	-	-
0.050	-	-	30V _{DC} /50Ω	-	-	-	-	-	-
0.100	-	-	30V _{DC} /15Ω	-	-	-	-	-	-
0.120	-	48V _{DC} /6.50Ω	-	-	-	-	-	-	-
0.140	-	-	-	60V _{DC} /6.00Ω	-	-	-	-	-
0.160	-	48V _{DC} /5.00Ω	-	-	-	-	-	-	-
0.200	-	24V _{DC} /3.30Ω	-	30V _{DC} /3.30Ω	-	-	-	-	-
0.300	-	-	-	-	60V _{DC} /2.30Ω	60V _{DC} /4.80Ω	-	-	-
0.350	6V _{DC} /1.4Ω	16V _{DC} /1.5Ω	6V _{DC} /1.3Ω	-	-	-	-	-	-
0.500	-	13.2V _{DC} /0.80Ω	13.2V _{DC} /0.90Ω	24V _{DC} /1.00Ω	-	60V _{DC} /1.40Ω	-	-	60V _{DC} /1.10Ω
0.750	-	6V _{DC} /0.40Ω	6V _{DC} /0.40Ω	13.2V _{DC} /0.45Ω	-	30V _{DC} /1.00Ω	-	-	-
	-	-	-	24V _{DC} /0.29Ω	-	60V _{DC} /1.00Ω	-	-	-
1.000	-	6V _{DC} /1.50Ω	-	-	15V _{DC} /0.40Ω	30V _{DC} /0.48Ω	-	-	-
	-	-	-	-	-	33V _{DC} /0.41Ω	-	-	-
1.100	-	6V _{DC} /0.20Ω	6V _{DC} /0.21Ω	8V _{DC} /0.21Ω	-	-	-	-	-
	-	-	-	16V _{DC} /0.18Ω	-	-	-	-	-
	-	-	-	24V _{DC} /0.18Ω	-	-	-	-	-
1.200	-	-	-	-	-	16V _{DC} /0.34Ω	-	-	-
1.250	-	-	-	6V _{DC} /0.14Ω	-	15V _{DC} /0.25Ω	-	-	-
	-	-	-	16V _{DC} /0.14Ω	-	-	-	-	-
1.500	-	6V _{DC} /0.11Ω	6V _{DC} /0.11Ω	6V _{DC} /0.11Ω	15V _{DC} /0.18Ω	-	15V _{DC} /0.25Ω	-	-
	-	-	-	12V _{DC} /0.11Ω	-	-	33V _{DC} /0.23Ω	-	-
	-	-	-	24V _{DC} /0.12Ω	-	-	-	-	-
1.600	-	-	-	9V _{DC} /0.10Ω	-	-	16V _{DC} /0.15Ω	-	-
1.750	-	-	6V _{DC} /0.08Ω	-	-	-	-	-	-
1.850	-	-	-	-	-	-	33V _{DC} /0.165Ω	-	-
1.900	-	-	-	-	-	-	-	16V _{DC} /0.08Ω	-
2.000	-	6V _{DC} /0.07Ω*	6V _{DC} /0.06Ω	8V _{DC} /0.07Ω	6V _{DC} /0.10Ω	-	15V _{DC} /0.125Ω	-	-
2.500	-	-	-	-	-	-	15V _{DC} /0.85Ω	-	-
2.600	-	-	-	6V _{DC} /0.043Ω	-	6V _{DC} /0.075Ω	-	-	-
	-	-	-	12V _{DC} /0.047Ω	-	-	-	-	-
	-	-	-	13.2V _{DC} /0.050Ω	-	-	-	-	-
	-	-	-	16V _{DC} /0.050Ω	-	-	-	-	-
3.000	-	-	-	-	-	6V _{DC} /0.048Ω	-	-	-

表 S2 温度折减 [环境温度(°C)下的保持电流(A)]

		最大环境温度											
元件型号		-40°C	-20°C	0°C	20°C	25°C	40°C	50°C	60°C	70°C	80°C	85°C	125°C
	picoSMD系列 尺寸 2012mm/0805mils												
	picoSMD035F	0.58	0.51	0.44	0.35	0.32	0.31	0.28	0.24	0.21	0.18	0.16	-
	nanoSMDC系列 尺寸 3216mm/1206mils												
	nanoSMDC012F	0.20	0.17	0.15	0.13	0.12	0.11	0.10	0.09	0.08	0.07	0.07	-
	nanoSMDC016F	0.21	0.20	0.18	0.16	0.16	0.14	0.13	0.12	0.11	0.10	0.09	-
	nanoSMDC020F	0.34	0.30	0.26	0.22	0.20	0.17	0.15	0.13	0.11	0.09	0.08	-
	nanoSMDC035F	0.58	0.51	0.44	0.38	0.35	0.31	0.28	0.24	0.21	0.18	0.16	-
	nanoSMDC050F/13.2	0.78	0.69	0.61	0.52	0.50	0.44	0.39	0.35	0.30	0.25	0.24	-
	nanoSMDC075F	1.15	1.04	0.92	0.78	0.75	0.69	0.63	0.58	0.51	0.46	0.43	-
	nanoSMDC110F	1.64	1.46	1.30	1.10	1.06	0.92	0.83	0.80	0.65	0.56	0.52	-
	nanoSMDC150F	2.20	1.99	1.77	1.55	1.50	1.34	1.23	1.10	1.01	0.90	0.84	-
即将推出	nanoSMDC200F*	3.56	3.08	2.60	2.12	2.00	1.79	1.64	1.50	1.36	1.21	1.14	-

*初步数据

表 S2 温度折减 [环境温度(°C)下的保持电流(A)]

续

元件型号	最大环境温度											
	-40°C	-20°C	0°C	20°C	25°C	40°C	50°C	60°C	70°C	80°C	85°C	125°C
microSMD系列												
尺寸3225mm/1210mils												
microSMD005F	0.08	0.07	0.06	0.05	0.05	0.04	0.04	0.03	0.03	0.02	0.02	-
microSMD010F	0.15	0.13	0.12	0.10	0.10	0.09	0.08	0.06	0.06	0.05	0.05	-
microSMD035F	0.51	0.46	0.40	0.35	0.34	0.30	0.27	0.24	0.22	0.19	0.18	-
microSMD050F	0.76	0.66	0.58	0.50	0.48	0.42	0.38	0.35	0.29	0.25	0.23	-
microSMD075F	1.10	0.97	0.86	0.75	0.72	0.64	0.58	0.55	0.47	0.42	0.39	-
microSMD110F	1.60	1.42	1.26	1.10	1.06	0.94	0.86	0.80	0.70	0.62	0.58	-
microSMD150F	2.30	2.02	1.76	1.50	1.43	1.24	1.11	1.00	0.85	0.72	0.65	-
microSMD175F	2.80	2.45	2.10	1.75	1.70	1.55	1.45	1.35	1.25	1.15	1.10	-
microSMD200F	2.60	2.44	2.35	2.00	1.96	1.78	1.67	1.50	1.45	1.15	1.10	-
miniSMDC系列												
尺寸4532mm/1812mils												
miniSMDC014F	0.23	0.20	0.17	0.14	0.13	0.11	0.10	0.09	0.07	0.06	0.05	-
miniSMDC020F	0.30	0.27	0.23	0.20	0.19	0.17	0.15	0.13	0.12	0.10	0.09	-
miniSMDC050F	0.59	0.57	0.55	0.50	0.48	0.45	0.43	0.35	0.30	0.25	0.23	-
miniSMDC075F	1.10	0.99	0.87	0.75	0.72	0.63	0.57	0.49	0.45	0.39	0.35	-
miniSMDC075F/24	1.50	1.25	1.00	0.75	0.73	0.65	0.60	0.55	0.50	0.45	0.43	-
miniSMDC110F	1.60	1.45	1.28	1.10	1.07	0.92	0.83	0.71	0.66	0.57	0.52	-
miniSMDC110F/16	1.68	1.49	1.30	1.10	1.05	0.92	0.83	0.75	0.64	0.55	0.50	-
miniSMDC110F/24	2.00	1.70	1.40	1.10	1.06	0.95	0.88	0.80	0.73	0.65	0.61	-
miniSMDC125F	2.00	1.69	1.47	1.25	1.17	1.03	0.92	0.90	0.69	0.58	0.53	-
miniSMDC125F/16	2.00	1.69	1.47	1.25	1.17	1.03	0.92	0.90	0.69	0.58	0.53	-
miniSMDC150F	2.30	2.05	1.77	1.50	1.44	1.23	1.09	0.95	0.82	0.68	0.61	-
miniSMDC150F/12	2.40	2.10	1.80	1.50	1.44	1.25	1.13	1.00	0.88	0.75	0.69	-
miniSMDC150F/24	2.10	1.90	1.70	1.50	1.44	1.25	1.13	1.00	0.88	0.75	0.69	-
miniSMDC160F	2.50	2.19	1.89	1.60	1.53	1.31	1.16	1.10	0.95	0.79	0.71	-
miniSMDC200F	2.60	2.44	2.22	2.00	1.96	1.78	1.67	1.50	1.45	1.34	1.29	-
miniSMDC260F	3.40	3.16	2.80	2.60	2.54	2.32	2.18	2.00	1.90	1.76	1.69	-
miniSMDC260F/12	3.40	3.16	3.00	2.60	2.54	2.32	2.18	2.00	1.90	1.76	1.69	-
miniSMDC260F/13.2	3.40	3.16	3.00	2.60	2.54	2.32	2.18	2.00	1.90	1.76	1.69	-
miniSMDC260F/16	3.50	3.20	3.00	2.60	2.53	2.30	2.15	2.00	1.85	1.70	1.63	-
miniSMDE系列												
尺寸11550mm/4420mils												
miniSMDE190F	3.16	2.74	2.20	1.90	1.74	1.48	1.27	1.10	0.80	0.50	0.35	-
midSMD系列												
尺寸5050mm/2018mils												
SMD030F-2018	0.48	0.42	0.35	0.30	0.28	0.24	0.21	0.17	0.15	0.12	0.10	-
decaSMDC050F/60	1.00	0.85	0.70	0.55	0.53	0.45	0.40	0.35	0.30	0.25	0.23	-
SMD100F-2018	1.59	1.43	1.20	1.10	1.03	0.94	0.85	0.72	0.69	0.61	0.57	-
SMD150F-2018	2.21	1.97	1.70	1.50	1.43	1.26	1.15	1.00	0.91	0.79	0.73	-
SMD200F-2018	2.81	2.54	2.27	2.00	1.93	1.73	1.59	1.46	1.32	1.19	1.12	-
SMD系列												
尺寸7555mm/2920mils												
SMD030F	0.44	0.39	0.32	0.30	0.28	0.26	0.23	0.19	0.18	0.17	0.15	-
SMD050F	0.73	0.65	0.55	0.50	0.47	0.43	0.39	0.33	0.31	0.28	0.26	-
SMD075F	1.11	0.99	0.84	0.75	0.71	0.63	0.57	0.49	0.45	0.39	0.36	-
SMD075F/60	1.11	0.99	0.84	0.75	0.71	0.63	0.57	0.49	0.45	0.39	0.36	-
SMD100F	1.59	1.43	1.20	1.10	1.03	0.94	0.85	0.72	0.69	0.61	0.57	-
SMD100F/33	1.48	1.35	1.20	1.10	1.06	0.98	0.91	0.83	0.79	0.73	0.69	-
SMDH120	2.34	1.96	1.58	1.20	1.15	1.02	0.92	0.83	0.74	0.65	0.60	0.26
SMD125F	1.89	1.68	1.50	1.25	1.21	1.04	0.93	0.85	0.71	0.61	0.55	-
SMD260F	3.82	3.41	2.90	2.60	2.45	2.19	1.99	1.70	1.58	1.38	1.28	-
SMD300F	4.13	3.75	3.30	3.00	2.87	2.62	2.43	2.25	2.00	1.87	1.78	-
SMD2系列												
尺寸8763mm/3425mils												
SMD150F	2.30	2.04	1.80	1.50	1.45	1.23	1.10	0.99	0.83	0.70	0.63	-
SMD150F/33	2.30	2.04	1.80	1.50	1.45	1.23	1.10	0.99	0.83	0.70	0.63	-
SMDH160	2.14	1.96	1.78	1.60	1.56	1.42	1.33	1.24	1.15	1.06	1.02	0.64
SMD185F	2.54	2.29	2.20	1.85	1.80	1.55	1.43	1.31	1.19	1.06	1.00	-
SMD200F	3.01	2.67	2.30	2.00	1.90	1.66	1.50	1.30	1.16	0.99	0.91	-
SMD250F	3.72	3.31	2.80	2.50	2.35	2.09	1.89	1.60	1.48	1.28	1.18	-

图 S1 温度折减曲线表

A = picoSMD / nanoSMD /
microSMD / miniSMD /
decaSMD and SMD

B = miniSMDE190F

C = SMDH120 and SMDH160



表 S3 常温下的电气特性

元件型号	I_H (A)	I_T (A)	V_{Max} (V _{DC})	I_{Max} (A)	$P_{D Max}$ (W)	最大动作时间 (A) (S)		R_{Min} (Ω)	$R_{1 Max}$ (Ω)	尺寸参见图
picoSMD系列 尺寸2012mm/0805mils										
新 picoSMD035F	0.35	0.75	6	20	0.60	3.50	0.10	0.42	1.40	S6
nanoSMDC系列 尺寸3216mm/1206mils										
nanoSMDC012F	0.12	0.39	48	10	0.50	1.00	0.20	1.40	6.50	S2
nanoSMDC016F	0.16	0.45	48	10	0.50	1.00	0.30	1.10	5.00	S2
nanoSMDC020F	0.20	0.42	24	100	0.60	8.00	0.10	0.65	3.30	S2
nanoSMDC035F	0.35	0.75	16	20	0.60	3.50	0.10	0.45	1.40	S2
nanoSMDC050F/13.2	0.50	1.10	13.2	100	0.80	8.00	0.10	0.20	0.80	S2
nanoSMDC075F	0.75	1.50	6	100	0.80	8.00	0.10	0.12	0.40	S2
nanoSMDC110F	1.10	2.20	6	100	0.80	8.00	0.10	0.07	0.20	S2
nanoSMDC150F	1.50	3.00	6	100	0.80	8.00	0.30	0.04	0.11	S2
即将推出 nanoSMDC200F*	2.00	4.00	6	100	1.00	8.00	TBD	0.02	0.07	S2
microSMD系列 尺寸3225mm/1210mils										
microSMD005F	0.05	0.15	30	10	1.00	0.25	1.50	3.60	50.00	S3
microSMD010F	0.10	0.25	30	10	0.80	0.50	1.00	2.10	15.00	S2
microSMD035F	0.35	0.75	6	40	0.80	8.00	0.20	0.32	1.30	S2
microSMD050F	0.50	1.00	13.2	40	0.80	8.00	0.05	0.25	0.90	S2
microSMD075F	0.75	1.50	6	40	0.80	8.00	0.10	0.11	0.40	S2
microSMD110F	1.10	2.20	6	40	0.80	8.00	0.20	0.07	0.21	S2
microSMD150F	1.50	3.00	6	40	0.80	8.00	1.00	0.04	0.11	S2
microSMD175F	1.75	3.50	6	40	0.80	8.00	0.80	0.025	0.08	S2
microSMD200F	2.00	4.00	6	100	0.80	8.00	2.50	0.020	0.06	S2
miniSMDC系列 尺寸4532mm/1812mils										
miniSMDC014F	0.14	0.28	60	10	0.75	8.00	0.008	1.50	6.00	S2
miniSMDC020F	0.20	0.40	30	10	0.80	8.00	0.02	0.60	3.30	S2
miniSMDC050F	0.50	1.00	24	100	0.80	8.00	0.15	0.15	1.00	S2
miniSMDC075F	0.75	1.50	13.2	100	1.00	8.00	0.20	0.11	0.45	S2
miniSMDC075F/24	0.75	1.50	24	40	0.80	8.00	0.30	0.09	0.29	S2
miniSMDC110F	1.10	2.20	8	100	1.20	8.00	0.30	0.04	0.21	S2
miniSMDC110F/16	1.10	2.20	16	100	0.80	8.00	0.30	0.06	0.18	S2
miniSMDC110F/24	1.10	2.20	24	20	0.80	8.00	0.50	0.06	0.18	S2
miniSMDC125F	1.25	2.50	6	100	0.80	8.00	0.40	0.05	0.14	S2
miniSMDC125F/16	1.25	2.50	16	100	0.80	8.00	0.40	0.05	0.14	S2
miniSMDC150F	1.50	3.00	6	100	0.80	8.00	0.50	0.04	0.11	S2
miniSMDC150F/12	1.50	2.80	12	100	0.80	8.00	0.50	0.04	0.11	S2
miniSMDC150F/24	1.50	3.00	24	20	1.00	8.00	1.50	0.04	0.12	S2
miniSMDC160F	1.60	3.20	9	100	0.80	8.00	1.00	0.03	0.10	S2
miniSMDC200F	2.00	4.00	8	100	1.00	8.00	5.00	0.02	0.07	S2
miniSMDC260F	2.60	5.00	6	100	1.00	8.00	7.00	0.015	0.043	S2

*初步数据

表 S3 常温下的电气特性

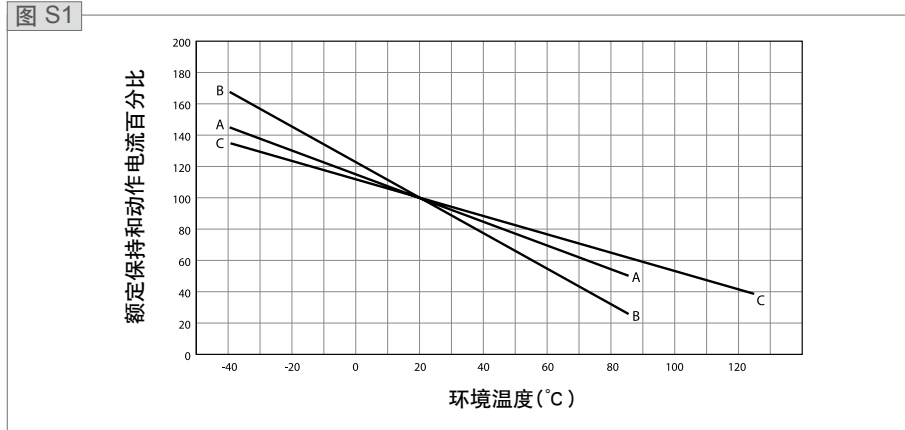
续

元件型号	I_H (A)	I_T (A)	V_{Max} (V _{DC})	I_{Max} (A)	$P_{D Max}$ (W)	最大动作时间 (A)	(S)	R_{Min} (Ω)	$R_{1 Max}$ (Ω)	尺寸参见图
miniSMDC系列										
尺寸4532mm/1812mils										
miniSMDC260F/12	2.60	5.00	12	100	1.00	8.00	5.00	0.015	0.047	S2
miniSMDC260F/13.2	2.60	5.00	13.2	100	1.20	8.00	5.00	0.015	0.050	S2
新 miniSMDC260F/16	2.60	5.00	16	100	1.20	8.00	5.00	0.015	0.050	S2
miniSMDE系列										
尺寸11550mm/4420mils										
miniSMDE190F	1.90	3.80	16	100	1.50	10.00	2.00	0.024	0.08	S2
midSMD系列										
尺寸5050mm/2018mils										
SMD030F-2018	0.30	0.80	60	20	0.90	1.50	1.50	0.50	2.30	S4
decaSMDC050F/60	0.55	1.10	60	10	1.00	8.00	0.10	0.40	1.10	S2
SMD100F-2018	1.10	2.20	15	40	1.40	8.00	0.50	0.10	0.40	S4
SMD150F-2018	1.50	3.00	15	40	1.80	8.00	1.00	0.07	0.18	S4
SMD200F-2018	2.00	4.20	6	40	1.50	8.00	3.00	0.048	0.10	S4
SMD系列										
尺寸7555mm/2920mils										
SMD030F	0.30	0.60	60	10	1.70	1.50	3.00	1.20	4.80	S5
SMD050F	0.50	1.00	60	10	1.70	2.50	4.00	0.35	1.40	S5
SMD075F	0.75	1.50	30	40	1.70	8.00	0.30	0.35	1.00	S5
SMD075F/60	0.75	1.50	60	10	1.70	8.00	0.30	0.35	1.00	S5
SMD100F	1.10	2.20	30	40	1.70	8.00	0.50	0.12	0.48	S5
SMD100F/33	1.10	2.20	33	40	1.70	8.00	0.50	0.12	0.41	S5
SMDH120	1.20	2.30	16	50	2.00	8.00	2.00	0.15	0.34	S5
SMD125F	1.25	2.50	15	40	1.70	8.00	2.00	0.07	0.25	S5
SMD260F	2.60	5.20	6	40	1.70	8.00	20.00	0.025	0.075	S5
SMD300F	3.00	6.00	6	40	1.50	8.00	35.00	0.015	0.048	S5
SMD2 Devices										
尺寸8763mm/3425mils										
SMD150F	1.50	3.00	15	40	1.90	8.00	5.00	0.06	0.25	S5
SMD150F/33	1.50	3.00	33	40	1.90	8.00	5.00	0.08	0.23	S5
SMDH160	1.60	3.20	16	70	2.20	8.00	15.00	0.05	0.15	S5
SMD185F	1.85	3.60	33	40	1.50	8.00	5.00	0.065	0.165	S5
SMD200F	2.00	4.00	15	40	1.90	8.00	12.00	0.05	0.125	S5
SMD250F	2.50	5.00	15	40	1.90	8.00	25.00	0.035	0.085	S5

图 S2-S6 尺寸描述



表 S4 产品尺寸 毫米(英寸)

元件型号	A		B		C		D		E		F		G		H		图表
	最小	最大	最小	最大	最小	最大	最小	最大	最小	最大	最小	最大	最小	最大	最小	最大	
■ picoSMD系列																	
尺寸2012mm/0805mils																	
新 picoSMD035F	1.80 (0.071)	2.21 (0.087)	0.38 (0.015)	0.81 (0.032)	1.17 (0.046)	1.45 (0.057)	0.15 (0.006)	0.60 (0.024)	-	-	-	-	-	-	-	-	S6
■ nanoSMDC系列																	
尺寸3216mm/1206mils																	
nanoSMDC012F	3.00 (0.118)	3.40 (0.134)	0.62 (0.024)	1.00 (0.039)	1.37 (0.054)	1.80 (0.071)	0.25 (0.010)	0.75 (0.030)	0.076 (0.003)	-	-	-	-	-	-	-	S2
nanoSMDC016F	3.00 (0.118)	3.40 (0.134)	0.62 (0.024)	1.00 (0.039)	1.37 (0.054)	1.80 (0.071)	0.25 (0.010)	0.75 (0.030)	0.076 (0.003)	-	-	-	-	-	-	-	S2
nanoSMDC020F	3.00 (0.118)	3.40 (0.134)	0.38 (0.015)	0.64 (0.025)	1.37 (0.054)	1.80 (0.071)	0.25 (0.010)	0.75 (0.030)	0.076 (0.003)	-	-	-	-	-	-	-	S2
nanoSMDC035F	3.00 (0.118)	3.40 (0.134)	0.38 (0.015)	0.64 (0.025)	1.37 (0.054)	1.80 (0.071)	0.25 (0.010)	0.75 (0.030)	0.076 (0.003)	-	-	-	-	-	-	-	S2
nanoSMDC050F/13.2	3.00 (0.118)	3.40 (0.134)	0.38 (0.015)	0.64 (0.025)	1.37 (0.054)	1.80 (0.071)	0.25 (0.010)	0.75 (0.030)	0.076 (0.003)	-	-	-	-	-	-	-	S2
nanoSMDC075F	3.00 (0.118)	3.40 (0.134)	0.28 (0.011)	0.48 (0.019)	1.37 (0.054)	1.80 (0.071)	0.25 (0.010)	0.75 (0.030)	0.076 (0.003)	-	-	-	-	-	-	-	S2
nanoSMDC110F	3.00 (0.118)	3.40 (0.134)	0.28 (0.011)	0.67 (0.026)	1.37 (0.054)	1.80 (0.071)	0.25 (0.010)	0.75 (0.030)	0.076 (0.003)	-	-	-	-	-	-	-	S2
nanoSMDC150F	3.00 (0.118)	3.40 (0.134)	0.55 (0.022)	0.89 (0.035)	1.37 (0.054)	1.80 (0.071)	0.25 (0.010)	0.75 (0.030)	0.076 (0.003)	-	-	-	-	-	-	-	S2
即将推出 nanoSMDC200F*	3.00 (0.118)	3.40 (0.134)	0.68 (0.027)	1.25 (0.049)	1.37 (0.054)	1.80 (0.071)	0.25 (0.010)	0.75 (0.030)	0.076 (0.003)	-	-	-	-	-	-	-	S2
■ microSMD系列																	
尺寸3225mm/1210mils																	
microSMD005F	3.0 (0.118)	3.43 (0.135)	0.50 (0.019)	0.85 (0.034)	2.35 (0.092)	2.80 (0.110)	0.25 (0.010)	0.75 (0.030)	0.076 (0.003)	-	-	-	-	-	-	-	S3
microSMD010F	3.0 (0.118)	3.43 (0.135)	0.50 (0.019)	0.85 (0.034)	2.35 (0.092)	2.80 (0.110)	0.25 (0.010)	0.75 (0.030)	0.076 (0.003)	-	-	-	-	-	-	-	S2
microSMD035F	3.0 (0.118)	3.43 (0.135)	0.38 (0.015)	0.62 (0.025)	2.35 (0.092)	2.80 (0.110)	0.25 (0.010)	0.75 (0.030)	0.076 (0.003)	-	-	-	-	-	-	-	S2
microSMD050F	3.0 (0.118)	3.43 (0.135)	0.38 (0.015)	0.62 (0.025)	2.35 (0.092)	2.80 (0.110)	0.25 (0.010)	0.75 (0.030)	0.076 (0.003)	-	-	-	-	-	-	-	S2
microSMD075F	3.0 (0.118)	3.43 (0.135)	0.38 (0.015)	0.62 (0.025)	2.35 (0.092)	2.80 (0.110)	0.25 (0.010)	0.75 (0.030)	0.076 (0.003)	-	-	-	-	-	-	-	S2
microSMD110F	3.0 (0.118)	3.43 (0.135)	0.28 (0.011)	0.48 (0.019)	2.35 (0.092)	2.80 (0.110)	0.25 (0.010)	0.75 (0.030)	0.076 (0.003)	-	-	-	-	-	-	-	S2
microSMD150F	3.0 (0.118)	3.43 (0.135)	0.51 (0.020)	1.22 (0.048)	2.35 (0.092)	2.80 (0.110)	0.25 (0.010)	0.75 (0.030)	0.076 (0.003)	-	-	-	-	-	-	-	S2
microSMD175F	3.0 (0.118)	3.43 (0.135)	0.40 (0.016)	0.76 (0.030)	2.35 (0.092)	2.80 (0.110)	0.25 (0.010)	0.75 (0.030)	0.076 (0.003)	-	-	-	-	-	-	-	S2
新 microSMD200F	3.0 (0.118)	3.43 (0.135)	0.79 (0.031)	1.17 (0.046)	2.35 (0.092)	2.80 (0.110)	0.25 (0.010)	0.75 (0.030)	0.076 (0.003)	-	-	-	-	-	-	-	S2
■ miniSMDC系列																	
尺寸4532mm/1812mils																	
miniSMDC014F	4.37 (0.172)	4.73 (0.186)	0.635 (0.025)	0.89 (0.035)	3.07 (0.121)	3.41 (0.134)	0.25 (0.010)	0.95 (0.040)	0.20 (0.008)	-	-	-	-	-	-	-	S2
miniSMDC020F	4.37 (0.172)	4.73 (0.186)	0.635 (0.025)	0.89 (0.035)	3.07 (0.121)	3.41 (0.134)	0.25 (0.010)	0.95 (0.040)	0.20 (0.008)	-	-	-	-	-	-	-	S2
miniSMDC050F	4.37 (0.172)	4.73 (0.186)	0.38 (0.015)	0.62 (0.025)	3.07 (0.121)	3.41 (0.134)	0.25 (0.010)	0.95 (0.040)	0.20 (0.008)	-	-	-	-	-	-	-	S2
miniSMDC075F	4.37 (0.172)	4.73 (0.186)	0.38 (0.015)	0.62 (0.025)	3.07 (0.121)	3.41 (0.134)	0.25 (0.010)	0.95 (0.040)	0.20 (0.008)	-	-	-	-	-	-	-	S2
miniSMDC075F/24	4.37 (0.172)	4.83 (0.190)	0.81 (0.032)	1.46 (0.057)	3.07 (0.121)	3.41 (0.134)	0.25 (0.010)	0.95 (0.040)	0.20 (0.008)	-	-	-	-	-	-	-	S2
miniSMDC110F	4.37 (0.172)	4.73 (0.186)	0.38 (0.015)	0.62 (0.025)	3.07 (0.121)	3.41 (0.134)	0.25 (0.010)	0.95 (0.040)	0.20 (0.008)	-	-	-	-	-	-	-	S2
miniSMDC110F/16	4.37 (0.172)	4.83 (0.190)	0.28 (0.011)	0.48 (0.019)	3.07 (0.121)	3.41 (0.134)	0.25 (0.010)	0.95 (0.040)	0.20 (0.008)	-	-	-	-	-	-	-	S2
miniSMDC110F/24	4.37 (0.172)	4.83 (0.190)	0.81 (0.032)	1.46 (0.057)	3.07 (0.121)	3.41 (0.134)	0.25 (0.010)	0.95 (0.040)	0.20 (0.008)	-	-	-	-	-	-	-	S2
miniSMDC125F	4.37 (0.172)	4.73 (0.186)	0.28 (0.011)	0.48 (0.019)	3.07 (0.121)	3.41 (0.134)	0.25 (0.010)	0.95 (0.040)	0.20 (0.008)	-	-	-	-	-	-	-	S2
miniSMDC125F/16	4.37 (0.172)	4.83 (0.190)	0.28 (0.011)	0.48 (0.019)	3.07 (0.121)	3.41 (0.134)	0.25 (0.010)	0.95 (0.040)	0.20 (0.008)	-	-	-	-	-	-	-	S2
miniSMDC150F	4.37 (0.172)	4.73 (0.186)	0.28 (0.011)	0.48 (0.019)	3.07 (0.121)	3.41 (0.134)	0.25 (0.010)	0.95 (0.040)	0.20 (0.008)	-	-	-	-	-	-	-	S2
miniSMDC150F/12	4.37 (0.172)	4.83 (0.190)	0.28 (0.011)	0.48 (0.019)	3.07 (0.121)	3.41 (0.134)	0.25 (0.010)	0.95 (0.040)	0.20 (0.008)	-	-	-	-	-	-	-	S2

*初步数据

表 S4 产品尺寸 毫米(英寸)

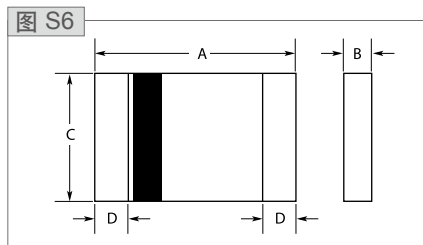
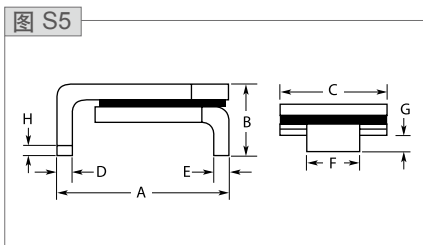
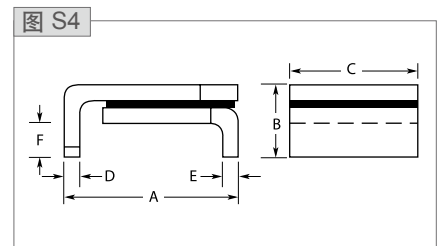
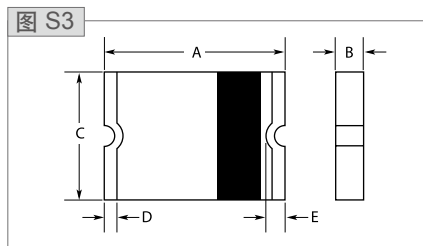
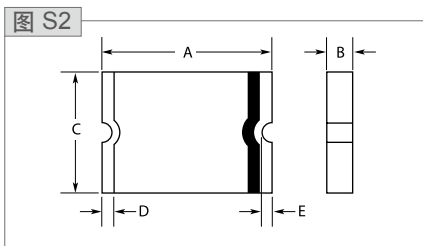
续

元件型号	A		B		C		D		E		F		G		H		图表
	最小	最大	最小	最大	最小	最大	最小	最大	最小	最大	最小	最大	最小	最大	最小	最大	
miniSMDC系列																	
尺寸4532mm/1812mils																	
miniSMDC150F/24	4.37 (0.172)	4.83 (0.190)	1.00 (0.040)	1.94 (0.077)	3.07 (0.121)	3.41 (0.134)	0.25 (0.010)	0.95 (0.040)	0.20 (0.008)	-	-	-	-	-	-	-	S2
miniSMDC160F	4.37 (0.172)	4.73 (0.186)	0.28 (0.011)	0.48 (0.019)	3.07 (0.121)	3.41 (0.134)	0.25 (0.010)	0.95 (0.040)	0.20 (0.008)	-	-	-	-	-	-	-	S2
miniSMDC200F	4.37 (0.172)	4.73 (0.186)	0.51 (0.020)	1.22 (0.048)	3.07 (0.121)	3.41 (0.134)	0.25 (0.010)	0.95 (0.040)	0.20 (0.008)	-	-	-	-	-	-	-	S2
miniSMDC260F	4.37 (0.172)	4.73 (0.186)	0.48 (0.019)	0.78 (0.031)	3.07 (0.121)	3.41 (0.134)	0.25 (0.010)	0.95 (0.040)	0.20 (0.008)	-	-	-	-	-	-	-	S2
miniSMDC260F/12	4.37 (0.172)	4.83 (0.190)	0.76 (0.030)	1.25 (0.050)	3.07 (0.121)	3.41 (0.134)	0.25 (0.010)	0.95 (0.040)	0.20 (0.008)	-	-	-	-	-	-	-	S2
miniSMDC260F/13.2	4.37 (0.172)	4.83 (0.190)	1.02 (0.042)	1.52 (0.060)	3.07 (0.121)	3.41 (0.134)	0.25 (0.010)	0.95 (0.040)	0.20 (0.008)	-	-	-	-	-	-	-	S2
新 miniSMDC260F/16	4.37 (0.172)	4.83 (0.190)	1.02 (0.042)	1.52 (0.060)	3.07 (0.121)	3.41 (0.134)	0.25 (0.010)	0.95 (0.040)	0.20 (0.008)	-	-	-	-	-	-	-	S2
miniSMDE系列																	
尺寸11550mm/4420mils																	
miniSMDE190F	11.15 (0.439)	11.51 (0.453)	0.33 (0.013)	0.53 (0.021)	4.83 (0.190)	5.33 (0.210)	0.51 (0.020)	1.02 (0.040)	0.381 (0.015)	-	-	-	-	-	-	-	S2
midSMD系列																	
尺寸5050mm/2018mils																	
SMD030F-2018	4.72 (0.186)	5.44 (0.214)	-	1.78 (0.070)	4.22 (0.166)	4.93 (0.194)	0.25 (0.010)	0.36 (0.014)	0.25 (0.010)	0.36 (0.014)	0.30 (0.012)	0.46 (0.018)	-	-	-	-	S4
decaSMDC050F/60	4.70 (0.185)	5.31 (0.209)	0.63 (0.025)	0.89 (0.035)	4.19 (0.165)	4.81 (0.189)	0.25 (0.010)	0.95 (0.040)	0.25 (0.010)	-	-	-	-	-	-	-	S2
SMD100F-2018	4.72 (0.186)	5.44 (0.214)	-	1.52 (0.060)	4.22 (0.166)	4.93 (0.194)	0.25 (0.010)	0.36 (0.014)	0.25 (0.010)	0.36 (0.014)	0.30 (0.012)	0.46 (0.018)	-	-	-	-	S4
SMD150F-2018	4.72 (0.186)	5.44 (0.214)	-	1.52 (0.060)	4.22 (0.166)	4.93 (0.194)	0.25 (0.010)	0.36 (0.014)	0.25 (0.010)	0.36 (0.014)	0.30 (0.012)	0.46 (0.018)	-	-	-	-	S4
SMD200F-2018	4.72 (0.186)	5.44 (0.214)	-	1.52 (0.060)	4.22 (0.166)	4.93 (0.194)	0.25 (0.010)	0.36 (0.014)	0.25 (0.010)	0.36 (0.014)	0.30 (0.012)	0.46 (0.018)	-	-	-	-	S4
SMD系列																	
尺寸7555mm/2920mils																	
SMD030F	6.73 (0.265)	7.98 (0.314)	-	3.18 (0.125)	4.80 (0.19)	5.44 (0.214)	0.56 (0.022)	0.71 (0.028)	0.56 (0.022)	0.71 (0.028)	2.16 (0.085)	2.41 (0.095)	0.66 (0.026)	1.37 (0.054)	0.43 (0.017)	-	S5
SMD050F	6.73 (0.265)	7.98 (0.314)	-	3.18 (0.125)	4.80 (0.19)	5.44 (0.214)	0.56 (0.022)	0.71 (0.028)	0.20 (0.008)	0.30 (0.012)	2.16 (0.085)	2.41 (0.095)	0.66 (0.026)	1.37 (0.054)	0.43 (0.017)	-	S5
SMD075F	6.73 (0.265)	7.98 (0.314)	-	3.18 (0.125)	4.80 (0.19)	5.44 (0.214)	0.56 (0.022)	0.71 (0.028)	0.56 (0.022)	0.71 (0.028)	2.16 (0.085)	2.41 (0.095)	0.66 (0.026)	1.37 (0.054)	0.43 (0.017)	-	S5
SMD075F/60	6.73 (0.265)	7.98 (0.314)	-	3.18 (0.125)	4.80 (0.19)	5.44 (0.214)	0.56 (0.022)	0.71 (0.028)	0.56 (0.022)	0.71 (0.028)	2.16 (0.085)	2.41 (0.095)	0.66 (0.026)	1.37 (0.054)	0.43 (0.017)	-	S5
SMD100F	6.73 (0.265)	7.98 (0.314)	-	3.00 (0.118)	4.80 (0.19)	5.44 (0.214)	0.56 (0.022)	0.71 (0.028)	0.56 (0.022)	0.71 (0.028)	2.16 (0.085)	2.41 (0.095)	0.66 (0.026)	1.37 (0.054)	0.43 (0.017)	-	S5
SMD100F/33	6.73 (0.265)	7.98 (0.314)	-	3.00 (0.118)	4.80 (0.19)	5.44 (0.214)	0.56 (0.022)	0.71 (0.028)	0.56 (0.022)	0.71 (0.028)	2.16 (0.085)	2.41 (0.095)	0.66 (0.026)	1.37 (0.054)	0.43 (0.017)	-	S5
SMDH120	6.73 (0.265)	7.98 (0.314)	-	3.00 (0.118)	4.80 (0.19)	5.44 (0.214)	0.56 (0.022)	0.71 (0.028)	0.56 (0.022)	0.71 (0.028)	2.16 (0.085)	2.41 (0.095)	0.66 (0.026)	1.37 (0.054)	0.43 (0.017)	-	S5
SMD125F	6.73 (0.265)	7.98 (0.314)	-	3.00 (0.118)	4.80 (0.19)	5.44 (0.214)	0.56 (0.022)	0.71 (0.028)	0.56 (0.022)	0.71 (0.028)	2.16 (0.085)	2.41 (0.095)	0.66 (0.026)	1.37 (0.054)	0.43 (0.017)	-	S5
SMD260F	6.73 (0.265)	7.98 (0.314)	-	3.00 (0.118)	4.80 (0.19)	5.44 (0.214)	0.56 (0.022)	0.71 (0.028)	0.56 (0.022)	0.71 (0.028)	2.16 (0.085)	2.41 (0.095)	0.66 (0.026)	1.37 (0.054)	0.43 (0.017)	-	S5
SMD300F	6.73 (0.265)	7.98 (0.314)	-	3.00 (0.118)	4.80 (0.19)	5.44 (0.214)	0.56 (0.022)	0.71 (0.028)	0.56 (0.022)	0.71 (0.028)	2.16 (0.085)	2.41 (0.095)	0.66 (0.026)	1.37 (0.054)	0.43 (0.017)	-	S5
SMD2 Devices																	
尺寸8763mm/3425mils																	
SMD150F	8.00 (0.315)	9.40 (0.370)	-	3.00 (0.118)	6.00 (0.236)	6.71 (0.264)	0.56 (0.022)	0.71 (0.028)	0.56 (0.022)	0.71 (0.028)	3.68 (0.145)	3.94 (0.155)	0.66 (0.026)	1.37 (0.054)	0.43 (0.017)	-	S5
SMD150F/33	8.00 (0.315)	9.40 (0.370)	-	3.00 (0.118)	6.00 (0.236)	6.71 (0.264)	0.56 (0.022)	0.71 (0.028)	0.56 (0.022)	0.71 (0.028)	3.68 (0.145)	3.94 (0.155)	0.66 (0.026)	1.37 (0.054)	0.43 (0.017)	-	S5
SMDH160	8.00 (0.315)	9.40 (0.370)	-	3.00 (0.118)	6.00 (0.236)	6.71 (0.264)	0.56 (0.022)	0.71 (0.028)	0.56 (0.022)	0.71 (0.028)	3.68 (0.145)	3.94 (0.155)	0.66 (0.026)	1.37 (0.054)	0.43 (0.017)	-	S5
SMD185F	8.00 (0.315)	9.40 (0.370)	-	3.00 (0.118)	6.00 (0.236)	6.71 (0.264)	0.56 (0.022)	0.71 (0.028)	0.56 (0.022)	0.71 (0.028)	3.68 (0.145)	3.94 (0.155)	0.66 (0.026)	1.37 (0.054)	0.43 (0.017)	-	S5
SMD200F	8.00 (0.315)	9.40 (0.370)	-	3.00 (0.118)	6.00 (0.236)	6.71 (0.264)	0.56 (0.022)	0.71 (0.028)	0.56 (0.022)	0.71 (0.028)	3.68 (0.145)	3.94 (0.155)	0.66 (0.026)	1.37 (0.054)	0.43 (0.017)	-	S5
SMD250F	8.00 (0.315)	9.40 (0.370)	-	3.00 (0.118)	6.00 (0.236)	6.71 (0.264)	0.56 (0.022)	0.71 (0.028)	0.56 (0.022)	0.71 (0.028)	3.68 (0.145)	3.94 (0.155)	0.66 (0.026)	1.37 (0.054)	0.43 (0.017)	-	S5

*初步数据

图 S7-S13 动作时间与相应电流曲线表(20°C)

picoSMDxxxF

A = picoSMD035F

图 S7

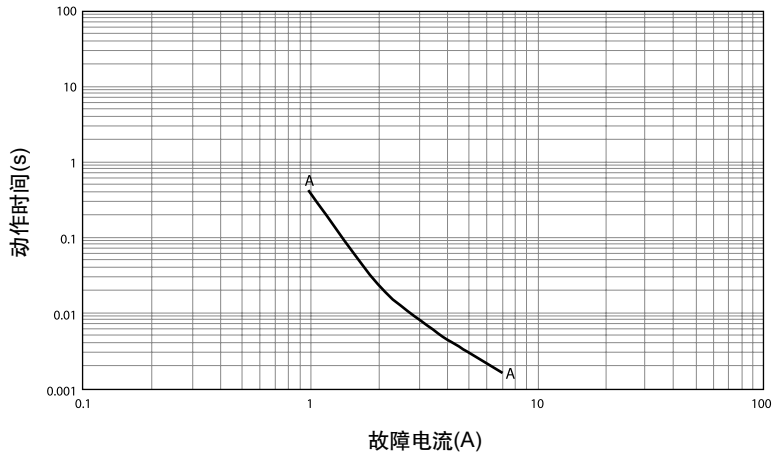

nanoSMDCxxxF

- A = nanoSMDC012F
- B = nanoSMDC016F
- C = nanoSMDC020F
- D = nanoSMDC035F
- E = nanoSMDC050F/13.2
- F = nanoSMDC075F
- G = nanoSMDC110F
- H = nanoSMDC150F

图 S8

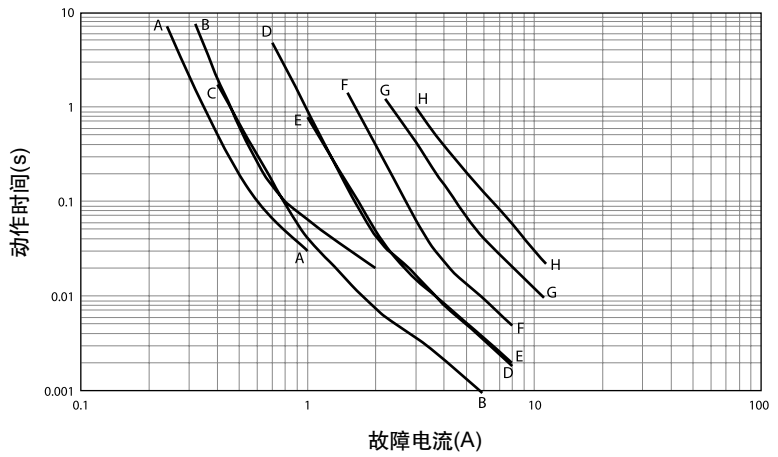

microSMDxxxF

- A = microSMD005F
- B = microSMD010F
- C = microSMD035F
- D = microSMD050F
- E = microSMD075F
- F = microSMD110F
- G = microSMD150F
- H = microSMD175F
- I = microSMD200F

图 S9



图 S7-S13 动作时间与相应电流曲线表(20°C)

续

miniSMDCxxxF and miniSMDExxxF

- A = miniSMDC014F
- B = miniSMDC020F
- C = miniSMDC050F
- D = miniSMDC075F, miniSMDC075F/24
- E = miniSMDC110F, miniSMDC110F/16, miniSMDC110F/24
- F = miniSMDC125F, miniSMDC125F/16
- G = miniSMDC150F, miniSMDC150F/12, miniSMDC150F/24
- H = miniSMDC160F
- I = miniSMDC200F
- J = miniSMDE190F
- K = miniSMDC260F, miniSMDC260F/12, miniSMDC260F/13.2, miniSMDC260F/16

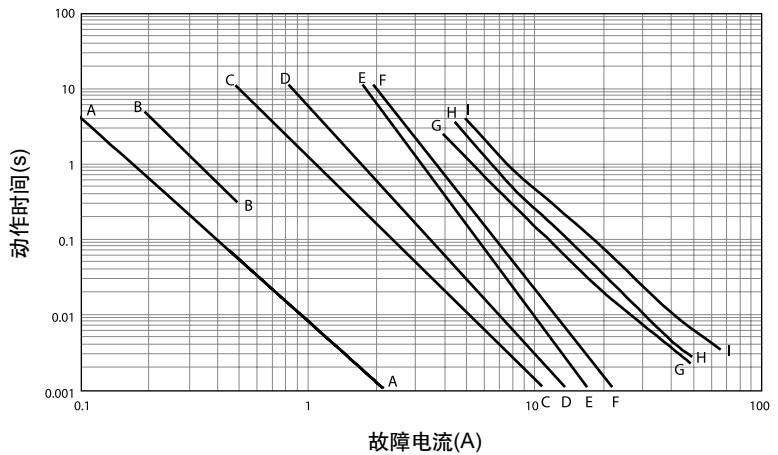
图 S10

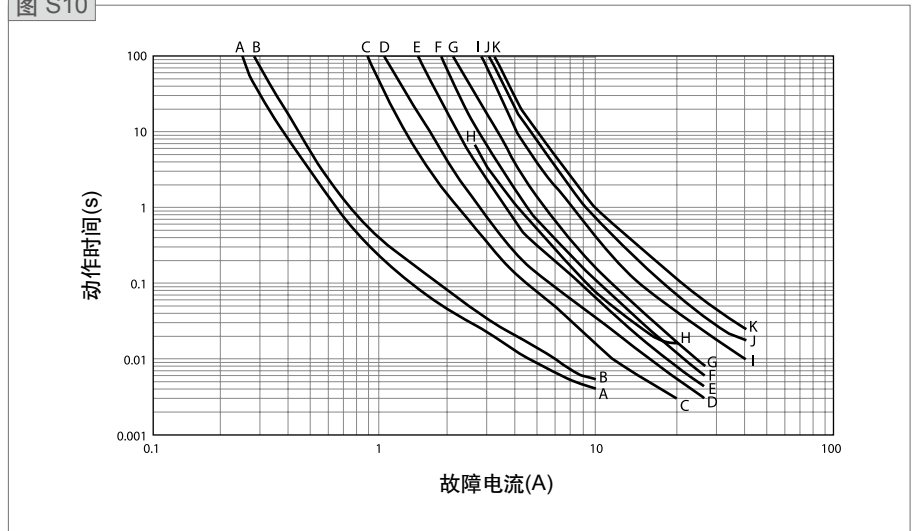

midSMD

- A = SMD030F-2018
- B = decaSMD050F/60
- C = SMD100F-2018
- D = SMD150F-2018
- E = SMD200F-2018

图 S11

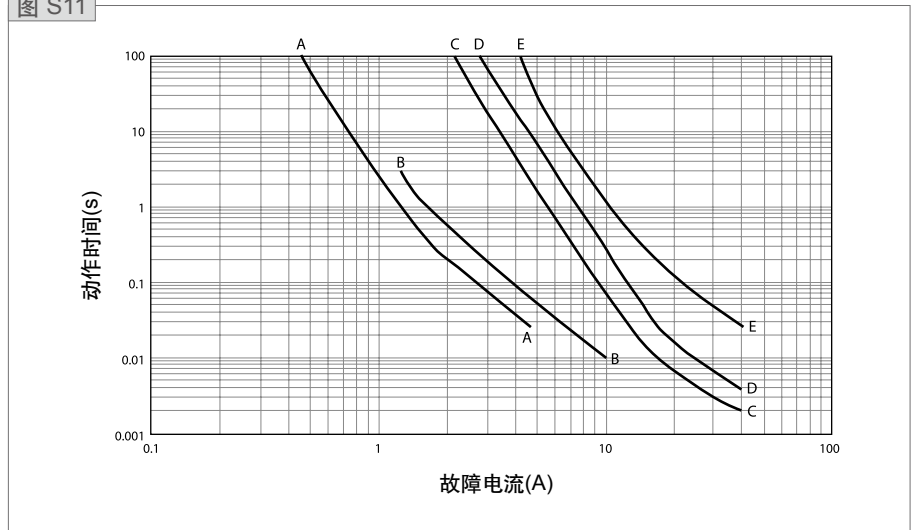

SMDxxxF

- A = SMD030F
- B = SMD050F
- C = SMD075F, SMD075F/60
- D = SMDH120
- E = SMD100F, SMD100F/33
- F = SMD125F
- G = SMD260F
- H = SMD300F

图 S12



图 S7-S13 动作时间与相应电流曲线表(20°C)

续

SMD2xxxF

- A = SMD150F, SMD150F/33
- B = SMDH160
- C = SMD185F
- D = SMD200F
- E = SMD250F

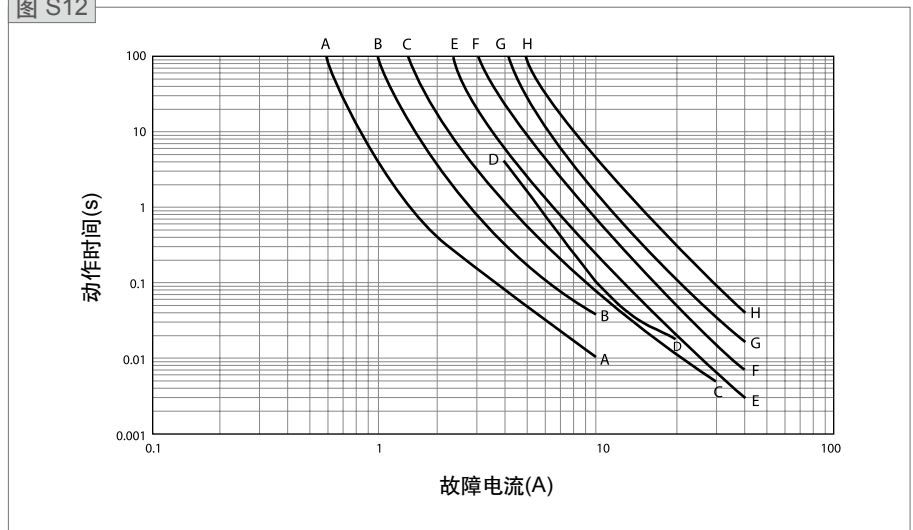

表 S5 物理特性和环境规范
(工作温度范围为-40°C到85°C, SMDH120和SMDH160为-40°C到125°C)

物理特性

接点焊接材料	100% 暗锡并以镍打底
焊接规范	nanoSMD, microSMD and miniSMD 系列采用 ANSI/J-STD-002 类目3 SMD系列采用 ANSI/J-STD-002类目1
焊接耐热性	采用 IEC-STD 68-2-20, 测试Tb, 第5款, 方法1A
阻燃性	采用IEC 695-2-2 针焰测试 20 秒.
推荐的储存条件	最高温度40°C, 最大湿度70% R.H.; 如果超过存储条件, 器件可能无法满足规范要求
湿度敏感性	采用 IPC/JEDEC J-STD 020C, 属于2a级。

环境规范

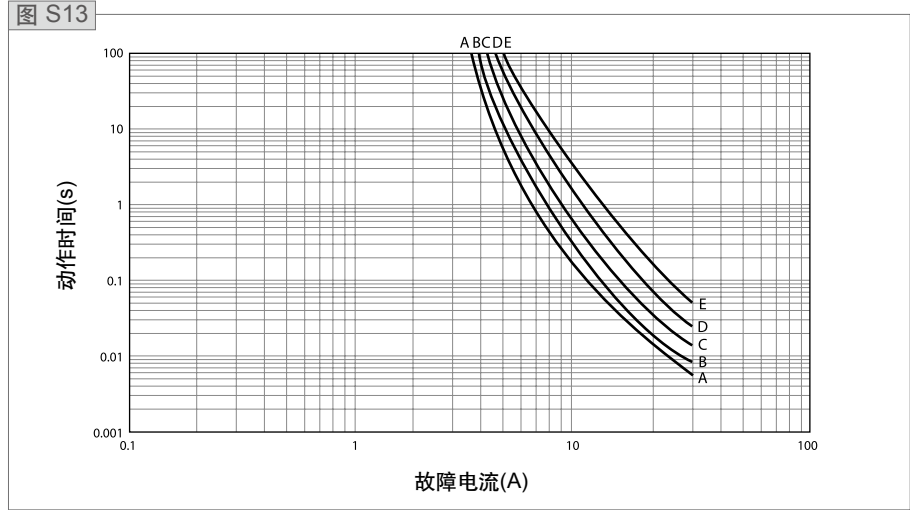
测试	测试方法	条件	电阻变化
保存期限	Raychem PS300, 第5.3.2款	60°C, 1000 小时	典型±3%
		85°C, 1000 小时	典型±5%
湿度老化	Raychem PS300, 第 5.3.1 款	85°C, 85% RH, 100 小时	典型±1.2%
热冲击	MIL-STD-202, 方法 107G	85°C, -40°C (20 次)	典型-33%
		125°C, -55°C (10 次)	典型-33%
振动	MIL-STD-883C	采用 MIL-STD-883C	无变化
溶剂电阻	Raychem PS300, 第 5.2.2款	氟里昂	无变化
		三氯乙烷	无变化
		烃	无变化

表 S6 包装方式和标识

续

				推荐的焊盘图表 图[mm (In.)]			
元件型号	卷带和盘式 包装数量	标准包装	产品标记	尺寸 A (Nom.)	尺寸 B (Nom.)	尺寸 C (Nom.)	机构认证
picoSMD系列							
尺寸2012mm/0805mils							
新 picoSMD035F	4,000	20,000	TBD	1.50 (0.060)	1.17(0.046)	1.00(0.040)	UL, CSA, TÜV
nanoSMDC系列							
尺寸3216mm/1206mils							
nanoSMDC012F	3,000	15,000	P	1.60 (0.063)	1.00 (0.039)	2.00 (0.079)	UL, CSA
nanoSMDC016F	3,000	15,000	N	1.60 (0.063)	1.00 (0.039)	2.00 (0.079)	UL, CSA, TÜV
nanoSMDC020F	3,000	15,000	02	1.60 (0.063)	1.00 (0.039)	2.00 (0.079)	UL, CSA, TÜV
nanoSMDC035F	3,000	15,000	03	1.60 (0.063)	1.00 (0.039)	2.00 (0.079)	UL, CSA, TÜV
nanoSMDC050F/13.2	3,000	15,000	M	1.60 (0.063)	1.00 (0.039)	2.00 (0.079)	UL, CSA, TÜV
nanoSMDC075F	3,000	15,000	L	1.60 (0.063)	1.00 (0.039)	2.00 (0.079)	UL, CSA, TÜV
nanoSMDC110F	3,000	15,000	K	1.60 (0.063)	1.00 (0.039)	2.00 (0.079)	UL, CSA, TÜV
nanoSMDC150F	3,000	15,000	15	1.60 (0.063)	1.00 (0.039)	2.00(0.079)	UL, CSA, TÜV
即将推出 nanoSMDC200F*	TBD	TBD	TBD	1.60 (0.063)	1.00 (0.039)	2.00 (0.079)	未定
microSMD系列							
尺寸3225mm/1210mils							
microSMD005F	4,000	20,000	05	2.50 (0.098)	1.00 (0.039)	2.00 (0.079)	UL, CSA, TÜV
microSMD010F	4,000	20,000	10	2.50 (0.098)	1.00 (0.039)	2.00 (0.079)	UL, CSA, TÜV
microSMD035F	4,000	20,000	3	2.50 (0.098)	1.00 (0.039)	2.00 (0.079)	UL, CSA, TÜV
microSMD050F	4,000	0,000	50	2.50 (0.098)	1.00 (0.039)	2.00 (0.079)	UL, CSA, TÜV
microSMD075F	4,000	20,000	75	2.50 (0.098)	1.00 (0.039)	2.00 (0.079)	UL, CSA, TÜV
microSMD110F	4,000	20,000	11	2.50 (0.098)	1.00 (0.039)	2.00 (0.079)	UL, CSA, TÜV
microSMD150F	4,000	20,000	15	2.50 (0.098)	1.00 (0.039)	2.00 (0.079)	UL, CSA, TÜV
microSMD175F	4,000	20,000	17	2.50 (0.098)	1.00 (0.039)	2.00 (0.079)	UL, CSA, TÜV
新 microSMD200F	3,000	15,000	20	2.50 (0.098)	1.00 (0.039)	2.00 (0.079)	UL, CSA, TÜV
miniSMDC系列							
尺寸4532mm/1812mils							
miniSMDC014F	2,000	10,000	14	2.95 (0.114)	1.68 (0.066)	3.10 (0.122)	UL, CSA, TÜV
miniSMDC020F	2,000	10,000	2	2.95 (0.114)	1.68 (0.066)	3.10 (0.122)	UL, CSA, TÜV
miniSMDC050F	2,000	10,000	5	2.95 (0.114)	1.68 (0.066)	3.10 (0.122)	UL, CSA, TÜV
miniSMDC075F	2,000	10,000	7	2.95 (0.114)	1.68 (0.066)	3.10 (0.122)	UL, CSA, TÜV
miniSMDC075F/24	1,500	7,500	075F 24V	2.95 (0.114)	1.68 (0.066)	3.10 (0.122)	UL, CSA, TÜV
miniSMDC110F	2,000	10,000	1	2.95 (0.114)	1.68 (0.066)	3.10 (0.122)	UL, CSA, TÜV
miniSMDC110F/16	2,000	10,000	110F 16V	2.95 (0.114)	1.68 (0.066)	3.10 (0.122)	UL, CSA, TÜV
miniSMDC110F/24	1,500	7,500	110F 24V	2.95 (0.114)	1.68 (0.066)	3.10 (0.122)	UL, CSA, TÜV
miniSMDC125F	2,000	10,000	12	2.95 (0.114)	1.68 (0.066)	3.10 (0.122)	UL, CSA, TÜV
miniSMDC125F/16	2,000	10,000	25F 16V	2.95 (0.114)	1.68 (0.066)	3.10 (0.122)	UL, CSA, TÜV
miniSMDC150F	2,000	10,000	15	2.95 (0.114)	1.68 (0.066)	3.10 (0.122)	UL, CSA, TÜV
miniSMDC150F/12	2,000	10,000	150F 12V	2.95 (0.114)	1.68 (0.066)	3.10 (0.122)	UL, CSA, TÜV
miniSMDC150F/24	1,000	5,000	150F 24V	2.95 (0.114)	1.68 (0.066)	3.10 (0.122)	UL, CSA, TÜV
miniSMDC160F	2,000	10,000	16	2.95 (0.114)	1.68 (0.066)	3.10 (0.122)	UL, CSA, TÜV
miniSMDC200F	2,000	10,000	20	2.95 (0.114)	1.68 (0.066)	3.10 (0.122)	UL, CSA, TÜV
miniSMDC260F	2,000	10,000	260F	2.95 (0.114)	1.68 (0.066)	3.10 (0.122)	UL, CSA, TÜV
miniSMDC260F/12	1,500	7,500	260F V	2.95 (0.114)	1.68 (0.066)	3.10 (0.122)	UL, CSA, TÜV
miniSMDC260F/13.2	1,500	7,500	260F 13.2	2.95 (0.114)	1.68 (0.066)	3.10 (0.122)	UL, CSA, TÜV
新 miniSMDC260F/16	1,500	7,500	260F 16V	2.95 (0.114)	1.68 (0.066)	3.10 (0.122)	UL, CSA, TÜV
miniSMDE系列							
尺寸11550mm/4420mils							
miniSMDE190F	5,000	20,000	19	4.75 (0.187)	1.45 (0.057)	9.57 (0.377)	UL, CSA, TÜV
midSMD系列							
尺寸5050mm/2018mils							
SMD030F-2018	4,000	20,000	A03F	4.60 (0.18)	1.50 (0.059)	3.40 (0.134)	UL, CSA, TÜV
decaSMDC050F/60	1,000	5,000	050F 60V	4.32 (0.17)	1.40 (0.055)	3.61 (0.142)	UL, CSA, TÜV
SMD100F-2018	4,000	20,000	A10F	4.60 (0.18)	1.50 (0.059)	3.40 (0.134)	UL, CSA, TÜV
SMD150F-2018	4,000	20,000	A15F	4.60 (0.18)	1.50 (0.059)	3.40 (0.134)	UL, CSA, TÜV
SMD200F-2018	4,000	20,000	A20F	4.60 (0.18)	1.50 (0.059)	3.40 (0.134)	UL, CSA, TÜV

*初步数据

元件型号	卷带和盘式 包装数量	标准包装	产品标记	推荐的焊盘图表 图[mm (In.)]			机构认证
				尺寸 A (Nom.)	尺寸 B (Nom.)	尺寸 C (Nom.)	
SMD系列							
尺寸7555mm/2920mils							
SMD030F	2,000	10,000	030F	3.10 (0.12)	2.30 (0.09)	5.10 (0.201)	UL, CSA, TÜV
SMD050F	2,000	10,000	050F	3.10 (0.12)	2.30 (0.09)	5.10 (0.201)	UL, CSA, TÜV
SMD075F	2,000	10,000	075F	3.10 (0.12)	2.30 (0.09)	5.10 (0.201)	UL, CSA, TÜV
SMD075F/60	2,000	10,000	756F	3.10 (0.12)	2.30 (0.09)	5.10 (0.201)	UL, CSA, TÜV
SMD100F	2,000	10,000	100F	3.10 (0.12)	2.30 (0.09)	5.10 (0.201)	UL, CSA, TÜV
SMD100F/33	2,000	10,000	103F	3.10 (0.12)	2.30 (0.09)	5.10 (0.201)	UL, CSA, TÜV
SMDH120	2,000	10,000	H12	3.10 (0.12)	2.30 (0.09)	5.10 (0.201)	UL, CSA
SMD125F	2,000	10,000	125F	3.10 (0.12)	2.30 (0.09)	5.10 (0.201)	UL, CSA, TÜV
SMD260F	2,000	10,000	260F	3.10 (0.12)	2.30 (0.09)	5.10 (0.201)	UL, CSA, TÜV
SMD300F	2,000	10,000	300F	3.10 (0.12)	2.30 (0.09)	5.10 (0.201)	UL, CSA, TÜV
SMD2 Devices							
尺寸8763mm/3425mils							
SMD150F	1,500	7,500	150F	4.60 (0.18)	2.30 (0.09)	6.10 (0.240)	UL, CSA, TÜV
SMD150F/33	1,500	7,500	153F	4.60 (0.18)	2.30 (0.09)	6.10 (0.240)	UL, CSA, TÜV
SMDH160	1,500	7,500	0F	4.60 (0.18)	2.30 (0.09)	6.10 (0.240)	UL, CSA
SMD185F	1,500	7,500	185F	4.60 (0.18)	2.30 (0.09)	6.10 (0.240)	UL, CSA, TÜV
SMD200F	1,500	7,500	200F	4.60 (0.18)	2.30 (0.09)	6.10 (0.240)	UL, CSA, TÜV
SMD250F	1,500	7,500	250F	4.60 (0.18)	2.30 (0.09)	6.10 (0.240)	UL, CSA, TÜV

图 S14 推荐焊盘设计

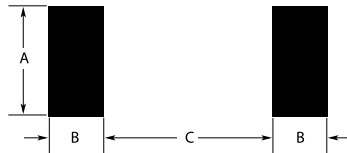

安规认证

UL	File # E74889
CSA	File # CA78165
TÜV	Certificate # R9872048 仅为microSMD and miniSMD系列 Certificate # R217206 为nanoSMD系列 Certificate # R9872049 为SMD系列 Certificate # R72041867 为decaSMD系列 Certificate # R72041427 为SMD系列 Certificate # R72072048 为SMDH系列

回流焊接和返工建议

回流分类

图形特征	锡铅	无铅
平均上升速度 ($T_{s_{max}}$ to T_p)	最大3°C/s.	最大3°C/s.
预热		
• 最小温度 ($T_{s_{min}}$)	100°C	150°C
• 最大温度 ($T_{s_{max}}$)	150°C	200°C
• 时间 ($t_{s_{min}}$ to $t_{s_{max}}$)	60-120s	60-180 s
维持下述温度以上的时间:		
• 温度 (T_L)	183°C	217°C
• 时间 (t_L)	60-150 s	60-150s
峰值温度 (T_p)	260°C	260°C
峰值温度正负5°C的时间		
温度 (t_p)	10-30s	20-40s
降温速率	最大6°C/s.	最大6°C/s.
从 25°C到峰值温度的时间	最多6分钟	最多8分钟.

注: 所有温度指正上面, 测量在产品表面进行

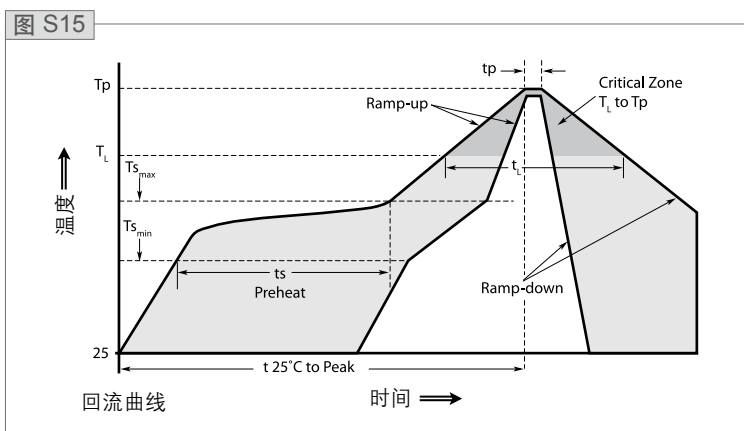

回流焊接

- 推荐回流方法:
 - 红外线
 - 热空气
 - 氮气
- 推荐使用的最大焊膏厚度:
 - nanoSMD、microSMD和miniSMD系列: 0.25mm (0.010英寸)
 - SMD系列: 0.38mm (0.015英寸)
- 元件可以用标准方法和水溶性溶剂进行清洗。
- 我们认为当每个元件通孔的下方施用合理用量的焊膏时,就可形成可接受的填角焊缝的最佳条件。有鉴于此,我们希望广大客户遵守我们所推荐使用的焊点布局。
- 我们要求客户电路板的布局在在PolySwitch的下方应避免有凸起部位(如通孔、铭牌、引线等)。凸起可能会对元件的可焊性能产生负面影响。

返工

- picoSMD、nanoSMD、microSMD和miniSMD系列: 标准的工业操作。另外也请避免直接与元件接触。
- SMD 系列: 重工应该只局限于拆除已经安装的产品并用新的产品替换。

表 S7 卷带包装规格(毫米)

种类	picoSMDC EIA 481-1	nanoSMDC EIA 481-1	microSMD EIA 481-1	miniSMDC EIA 481-1	miniSMDE190 EIA 481-2	midSMD EIA 481-2	SMD EIA 481-2	SMD2 EIA 481-2
W	8.0±0.30	8.0± 0.30	8.0±0.30	12.0±0.30	24.0±0.30	16.0±0.30	16.0±0.30	16.0±0.30
P ₀	4.0±0.10	4.0 ±0.10	4.0±0.10	4.0±0.10	4.0±0.10	4.0±0.10	4.0±0.10	4.0±0.10
P ₁	4.0±0.10	4.0±0.10	4.0±0.10	8.0±0.10	8.0±0.10	8.0±0.10	8.0 ±0.10	12.0±0.10
P ₂	2.0±0.05	2.0±0.05	2.0±0.05	2.0±0.05	2.0±0.10	2.0±0.10	2.0±0.10	2.0±0.10
A ₀	Table S8	1.95±0.10	2.9±0.10	Table S8	5.70±0.10	5.11±0.15	5.6±0.23	6.9±0.23
B ₀	Table S8	3.50±0.10	3.50±0.10	Table S8	11.90±0.10	5.6±0.23	8.1±0.15	9.6±0.15
B ₁ max.	4.35	4.35	4.35	8.2	20.1	12.1	12.1	12.1
D ₀	1.55±.05	1.55±.05	1.55±.05	1.5+ 0.10/-0.00	1.55±.05	1.5+ 0.10/-0.00	1.5+ 0.10/-0.00	1.5+ 0.10/-0.00
F	3.50±0.05	3.50±0.05	3.50±0.05	5.50±0.05	11.50±0.10	7.50±0.10	7.50±0.10	7.50±0.10
E ₁	1.75±0.10	1.75±0.10	1.75±0.10	1.75±0.10	1.75±0.10	1.75±0.10	1.75±0.10	1.75±0.10
E ₂ min.	6.25	6.25	6.25	10.25	22.25	14.25	14.25	14.25
T max.	0.6	0.6	0.6	0.6	0.6	0.6	0.6	0.6
T ₁ max.	0.1	0.1	0.1	0.1	0.1	0.1	0.1	0.1
K ₀	Table S8	0.89±0.10	Table S8	Table S8	0.95±0.10	1.8±0.15	3.2±0.15	3.4±0.15
Leader min.	390	390	390	390	400	400	400	400
Trailer min.	160	160	160	160	160	160	160	160

表 S8 卷带包装规格(毫米)

	All pico SMD035F	All nanoSMD系列 except nanoSMDC150F	nano SMDC150F	All microSMD系列 except microSMDC200F	micro SMD200F	All miniSMD系列 and miniSMDC200F miniSMDC260F	All miniSMDC075F/24 miniSMDC110F/24 miniSMDC260F/12 miniSMDC260F/13.2 miniSMDC260F/16	mini SMDC150F/24	deca SMDC050F/60
A ₀	1.70±0.1	1.95±0.1	1.95±0.10	2.9±0.1	2.90±0.1	3.5±0.1	3.7±0.1	3.70±0.1	5.0±0.1
B ₀	2.45±0.1	3.50+0.1/-0.08	3.53±0.07	3.5±0.1	3.50±0.1	5.1±0.1	4.9±0.1	4.90±0.1	5.4±0.1
K ₀	0.86±0.1	0.89±0.1	0.94±0.05	0.9±0.1	1.27±0.1	0.9±0.1	1.4±0.1	1.78±0.1	1.7±0.1

表 S9 卷带包装规格(毫米)

	pico/nano/microSMD	miniSMDC	miniSMDE190	midSMD	SMD	SMD2
A max.	185	185	330	330	330	330
N min.	50	50	60	5050	50	
W ₁	8.4 + 1.5/-0.00	12.4 + 2.0/-0.00	4.4 + 2.0/-0.00	16.4 + 2.0/-0.00	16.4 + 2.0/-0.00	16.4 + 2.0/-0.00
W ₂ max.	14.4	18.4	30.4	22.4	22.4	22.4

图 S16 EIA盘尺寸



图 S17 EIA盘尺寸



型号说明

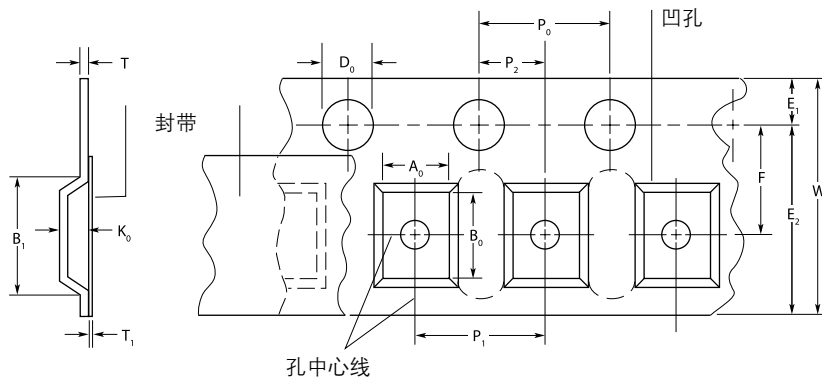
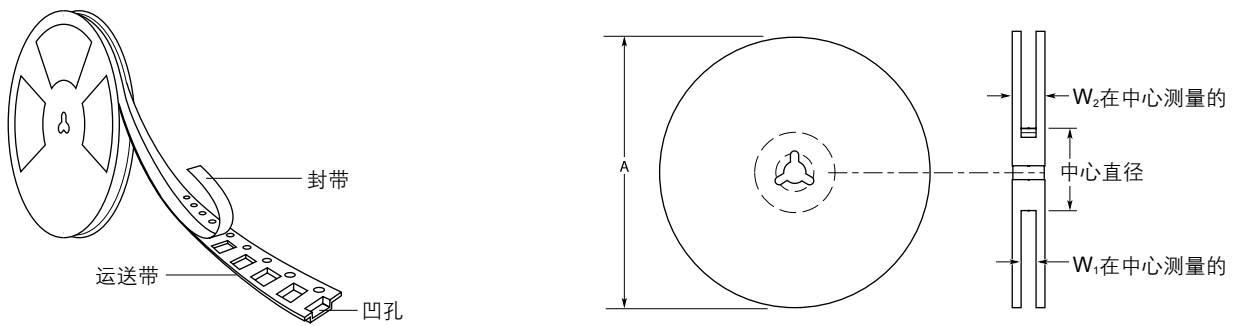
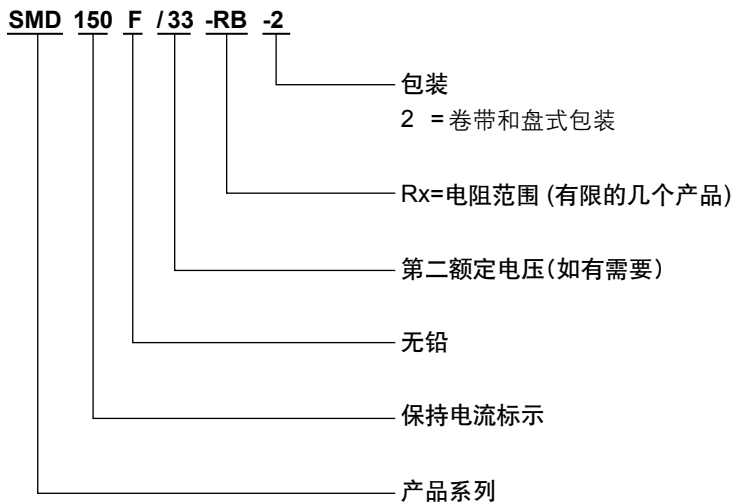

警告

- 超出额定范围进行操作或不正确地使用设备都可能会导致元件损坏，并可能产生电弧和火焰。
- 这些元件都用于当发生偶然的过流或超温故障时进行保护，切勿用于故障频繁发生的场合或预期会发生超长时间的动作事件的场合。
- PPTC材料污染了一定量的硅基油后或染上某些侵蚀性溶剂后可能会对元件的性能产生不利影响。
- 如果不按照我们推荐使用的电子、热学以及机械程序来对电子部件进行处理，则元件性能可能会受到不利影响。
- 在电感量很大的电路中操作时，可能会产生超过PolySwitch自复式元件额定电压的回路电压(Ldi / dt)。