5050 SMD LED

Applications

- Signal & Symbol Indicators.
- Illuminations(illuminated advertising & general lighting).
- Amusement Machines.
- LCD Backlighting.
- Indoor & Outdoor Displays.
- Automobile Interior Lighting.

1. RED 5050 SMD LED

PART NO	Chip		Lens Color
	Material	Emitted Color	
LED-5050RVC	AlGaInP	Red ■	WATER CLEAR

Absolute Maximum Ratings (Ta = 25°C)

Items	Symbol	Absolute maximum Rating	Unit
Power Dissipation	PD	300	mW
Forward Current(DC)	IF	150	mA
Peak Forward Current *	IFP	300	mA
Reverse Voltage	VR	5	V
Operation Temperature	Topr	-40 ~ +95	°C
Storage Temperature	Tstg	-40 ~ +100	°C
Soldering Temperature	Tsol	Reflow Soldering:240°C/10sec Hand Soldering: 350°C/3sec	

*Pulse width \leq 0.1msec duty \leq 1/10

Typical Electrical & Optical Characteristics (Ta = 25°C)

Items	Symbol	Condition	Min.	Typ.	Max.	Unit
Forward Voltage	VF	IF = 60mA	1.7		2.4	V
Reverse Current	IR	VR = 5V			10	μ A
Dominant Wavelength	WLD	IF =60mA	620		630	nm
Luminous Intensity	IV	IF = 60mA	1200		3500	mcd
50% Power Angle	2 θ $\frac{1}{2}$	IF = 60mA		120		Deg

Typical Electrical/Optical Characteristics Curves (Ta=25° Unless Otherwise Noted)

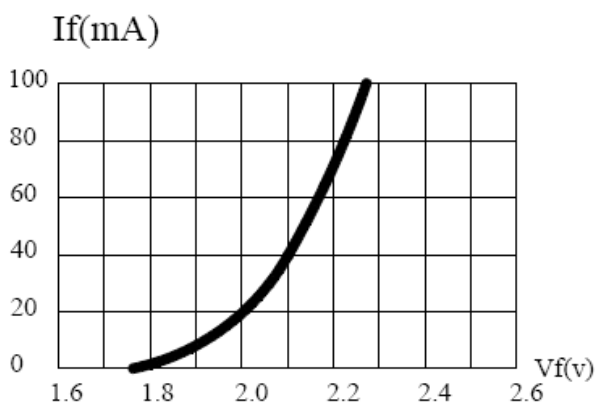

Fig. 1 Forward Current vs Forward Voltage

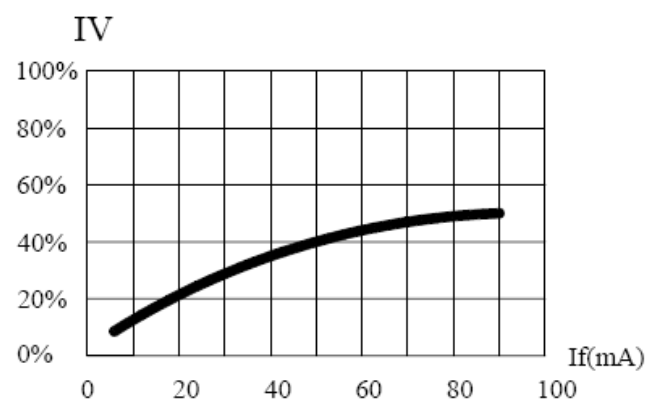

Fig. 2 Relative Luminous Flux vs Forward Current

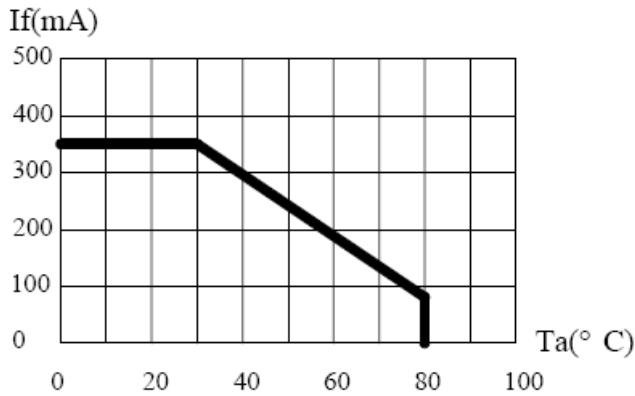

Fig. 3 Maximum Forward Current vs Ambient Temperature

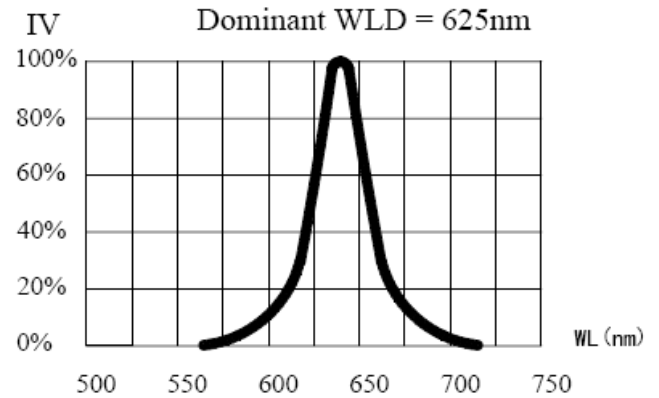

Fig. 4 Relative Luminous Flux vs Wavelength

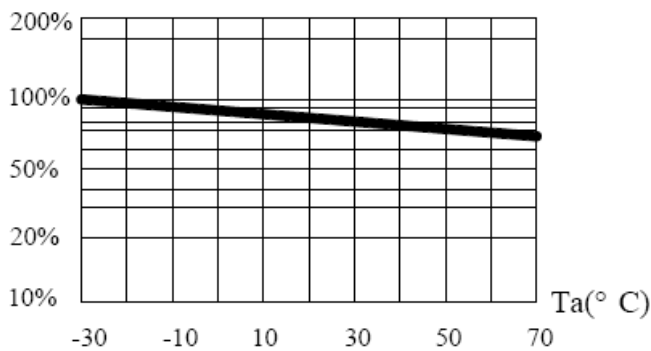

Fig. 5 Relative Luminous Flux vs Ambient Temperature

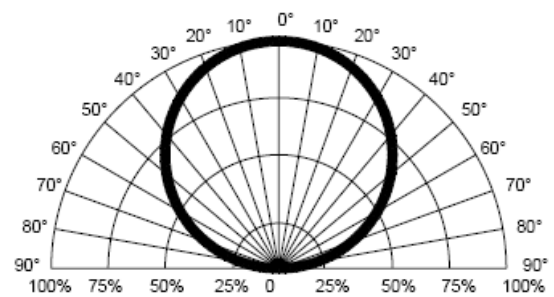

Fig. 6 Relative Luminous Flux vs Radiation Angle

2. YELLOW 5050 SMD LED

PART NO	Chip		Lens Color
	Material	Emitted Color	
LED-5050YVC	AlGaInP	Yellow ■	WATER CLEAR

Absolute Maximum Ratings (Ta = 25 °C)

Items	Symbol	Absolute maximum Rating	Unit
Power Dissipation	PD	450	mW
Forward Current(DC)	IF	150	mA
Peak Forward Current *	IFP	300	mA
Reverse Voltage	VR	5	V
Operation Temperature	Topr	-40 ~ +95	°C
Storage Temperature	Tstg	-40 ~ +100	°C
Soldering Temperature	Tsol	Reflow Soldering:240°C/10sec Hand Soldering: 350°C/3sec	

*Pulse width \leq 0.1msec duty \leq 1/10

Typical Electrical & Optical Characteristics (Ta = 25°C)

Items	Symbol	Condition	Min.	Typ.	Max.	Unit
Forward Voltage	VF	IF = 60mA	1.7		2.4	V
Reverse Current	IR	VR = 5V			10	μA
Dominant Wavelength	WLD	IF = 60mA	580		595	nm
Luminous Intensity	IV	IF = 60mA	1200		3500	mcd
50% Power Angle	2θ½	IF = 60mA		120		Deg

Typical Electrical/Optical Characteristics Curves (Ta=25° Unless Otherwise Noted)

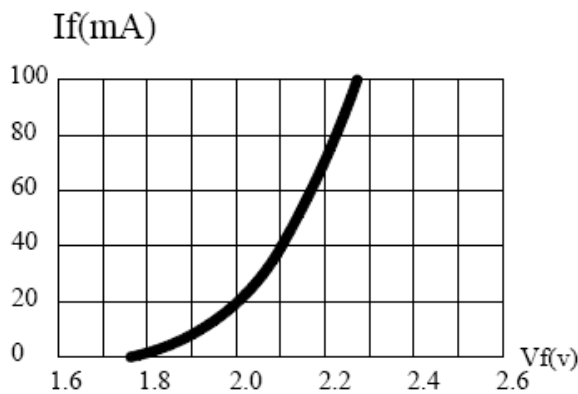

Fig. 1 Forward Current vs Forward Voltage

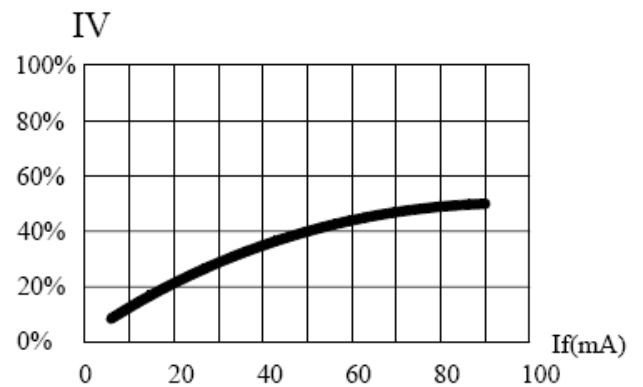

Fig. 2 Relative Luminous Flux vs Forward Current

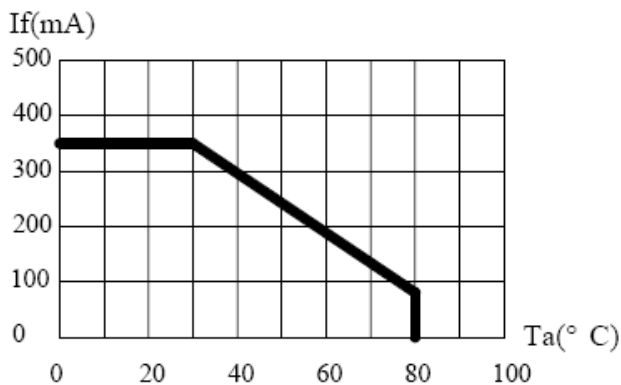

Fig. 3 Maximum Forward Current vs Ambient Temperature

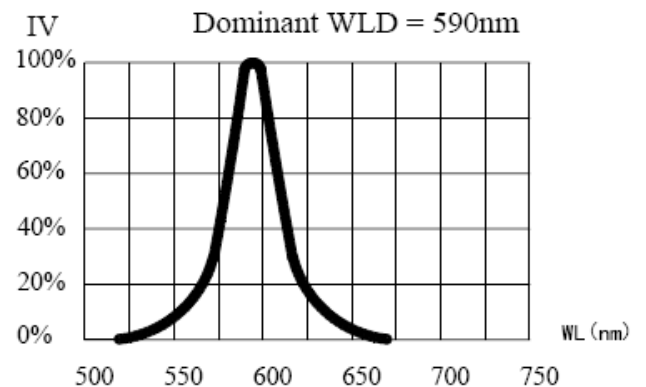

Fig. 4 Relative Luminous Flux vs Wavelength

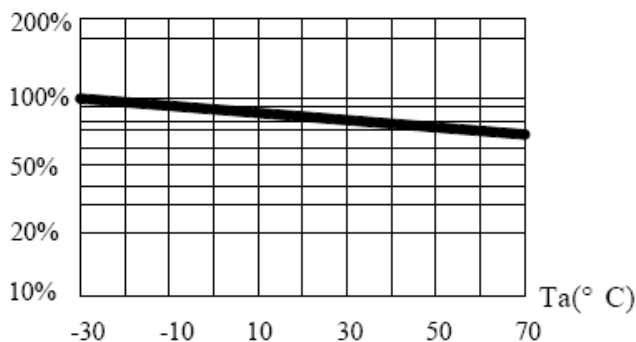

Fig. 5 Relative Luminous Flux vs Ambient Temperature

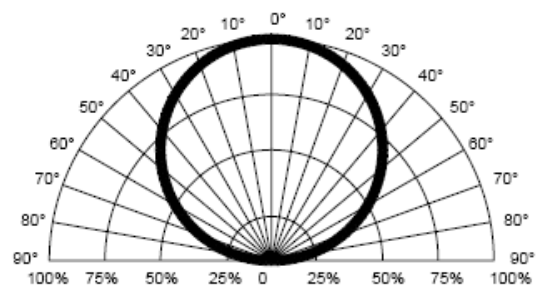

Fig. 6 Relative Luminous Flux vs Radiation Angle

3. GREEN 5050 SMD LED

PART NO	Chip		Lens Color
	Material	Emitted Color	
LED-5050GVC	InGaN	Green ■	WATER CLEAR

Absolute Maximum Ratings (Ta = 25°C)

Items	Symbol	Absolute maximum Rating	Unit
Power Dissipation	PD	450	mW
Forward Current(DC)	IF	150	mA
Peak Forward Current *	IFP	300	mA
Reverse Voltage	VR	5	V
Operation Temperature	Topr	-40 ~ +95	°C
Storage Temperature	Tstg	-40 ~ +100	°C
Soldering Temperature	Tsol	Reflow Soldering:240°C/10sec Hand Soldering: 350°C/3sec	

*Pulse width \leq 0.1msec duty \leq 1/10

Typical Electrical & Optical Characteristics (Ta = 25°C)

Items	Symbol	Condition	Min.	Typ.	Max.	Unit
Forward Voltage	VF	IF = 60mA	2.8		3.6	V
Reverse Current	IR	VR = 5V			10	μ A
Dominant Wavelength	WLD	IF = 60mA	515		535	nm
Luminous Intensity	IV	IF = 60mA	2500		5500	mcd
50% Power Angle	2 θ $\frac{1}{2}$	IF = 60mA		120		Deg

Typical Electrical/Optical Characteristics Curves (Ta=25° Unless Otherwise Noted)

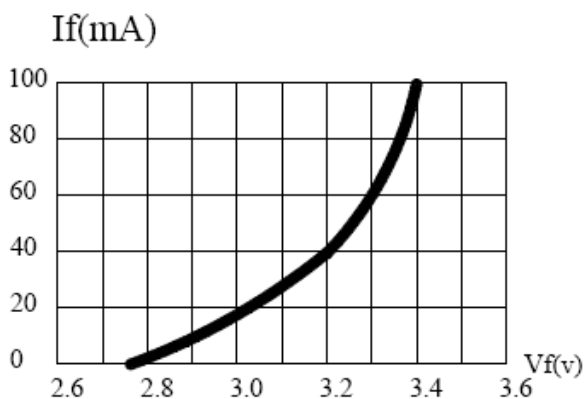

Fig. 1 Forward Current vs Forward Voltage

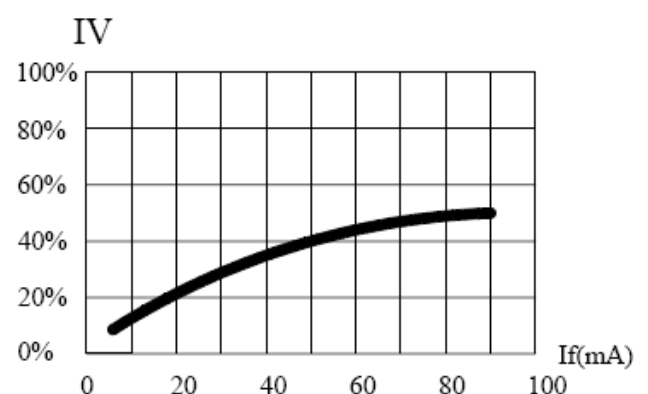

Fig. 2 Relative Luminous Flux vs Forward Current

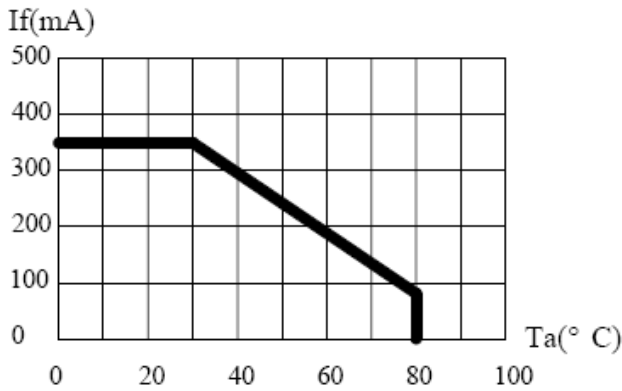

Fig. 6 Maximum Forward Current vs Ambient Temperature

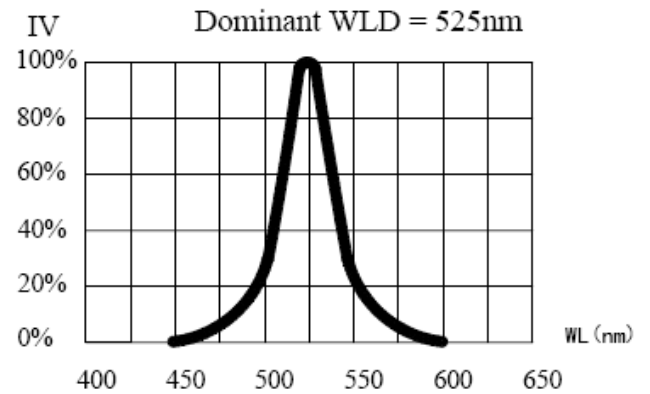

Fig. 4 Relative Luminous Flux vs Wavelength

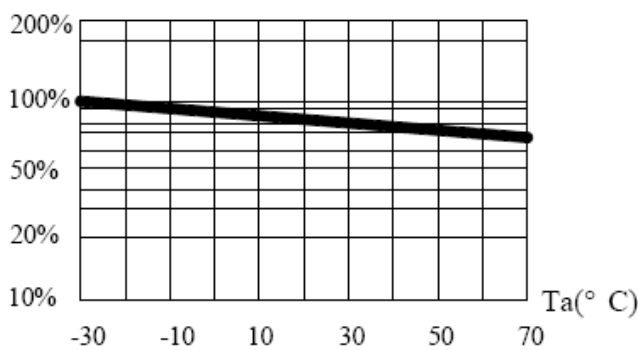

Fig. 5 Relative Luminous Flux vs Ambient Temperature

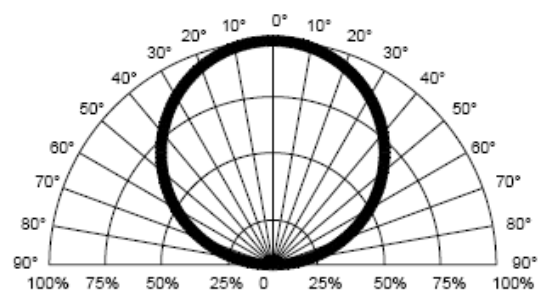

Fig. 6 Relative Luminous Flux vs Radiation Angle

4. BLUE 5050 SMD LED

PART NO	Chip		Lens Color
	Material	Emitted Color	
LED-5050BVC	InGaN	Blue ■	WATER CLEAR

Absolute Maximum Ratings (Ta = 25°C)

Items	Symbol	Absolute maximum Rating	Unit
Power Dissipation	PD	450	mW
Forward Current(DC)	IF	150	mA
Peak Forward Current *	IFP	300	mA
Reverse Voltage	VR	5	V
Operation Temperature	Topr	-40 ~ +95	°C
Storage Temperature	Tstg	-40 ~ +100	°C
Soldering Temperature	Tsol	Reflow Soldering:240°C/10sec Hand Soldering: 350°C/3sec	

*Pulse width ≤ 0.1msec duty ≤ 1/10

Typical Electrical & Optical Characteristics (Ta = 25°C)

Items	Symbol	Condition	Min.	Typ.	Max.	Unit
Forward Voltage	VF	IF = 60mA	2.8		3.6	V
Reverse Current	IR	VR = 5V			10	μA
Dominant Wavelength	WLD	IF = 60mA	460		475	nm
Luminous Intensity	IV	IF = 60mA	1000		3500	mcd
50% Power Angle	2θ½	IF = 60mA		120		Deg

Typical Electrical/Optical Characteristics Curves (Ta=25° Unless Otherwise Noted)

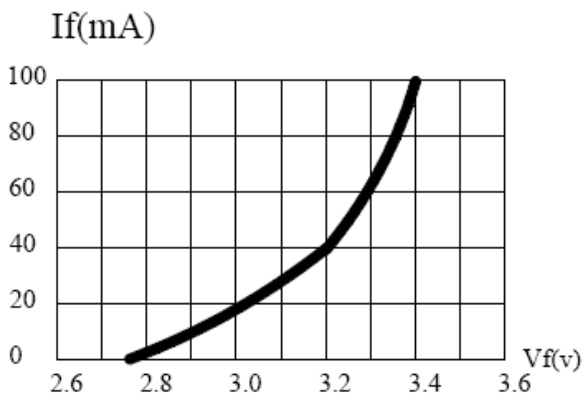

Fig. 1 Forward Current vs Forward Voltage

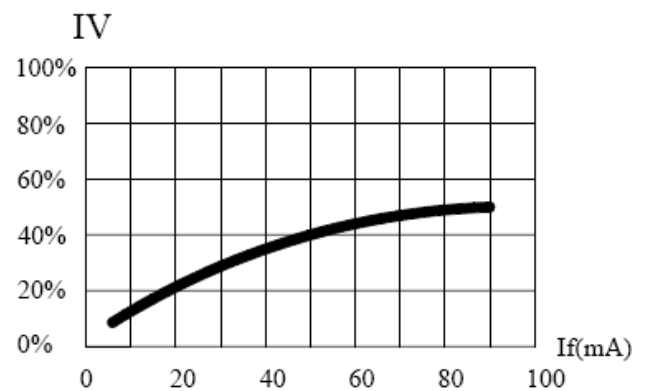

Fig. 2 Relative Luminous Flux vs Forward Current

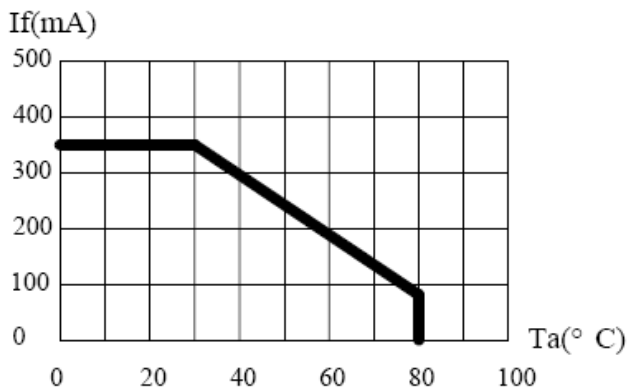

Fig. 6 Maximum Forward Current vs Ambient Temperature

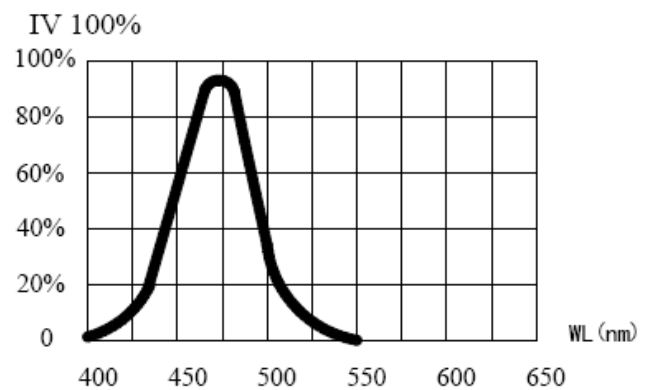

Fig. 4 Relative Luminous Flux vs Wavelength

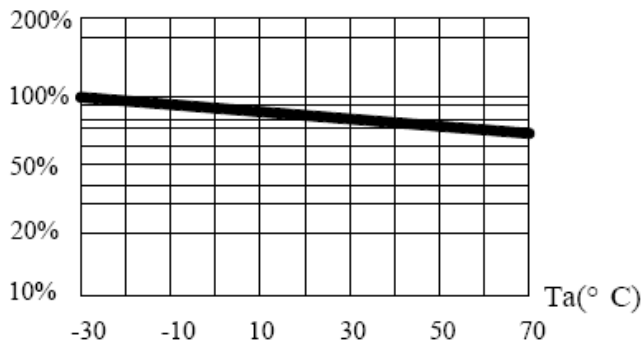

Fig. 5 Relative Luminous Flux vs Ambient Temperature

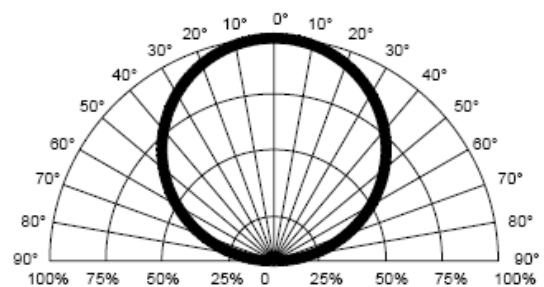

Fig. 6 Relative Luminous Flux vs Radiation Angle

5. WHITE 5050 SMD LED

PART NO	Chip		Lens Color
	Material	Emitted Color	
LED-5050WVC	InGaN	White □	WATER CLEAR

Absolute Maximum Ratings (Ta = 25°C)

Items	Symbol	Absolute maximum Rating	Unit
Power Dissipation	PD	450	mW
Forward Current(DC)	IF	150	mA
Peak Forward Current *	IFP	300	mA
Reverse Voltage	VR	5	V
Operation Temperature	Topr	-40 ~ +95	°C
Storage Temperature	Tstg	-40 ~ +100	°C
Soldering Temperature	Tsol	Reflow Soldering:240°C/10sec Hand Soldering: 350°C/3sec	

*Pulse width \leq 0.1msec duty \leq 1/10

Typical Electrical & Optical Characteristics (Ta = 25°C)

Items	Symbol	Condition	Min.	Typ.	Max.	Unit
Forward Voltage	VF	IF = 60mA	2.8		3.6	V
Reverse Current	IR	VR = 5V			10	μ A
Chromatic Coordinates	(X,Y)	IF =60mA			(0.30,0.30)	nm
Luminous Intensity	IV	IF = 60mA	5000		6000	mcd
			14		16	LM
50% Power Angle	2 θ ½	IF = 60mA		120		Deg

CIE Chromaticity Chart

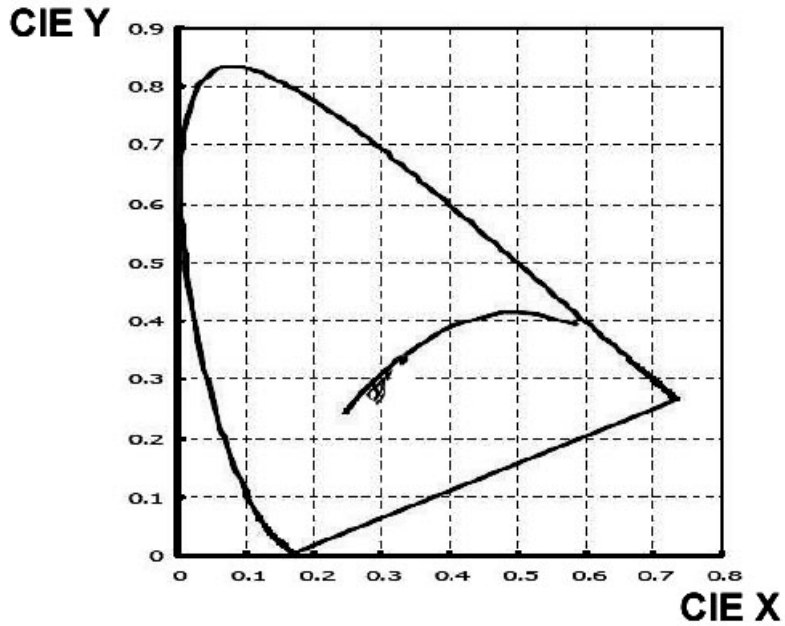

Color Coordinate

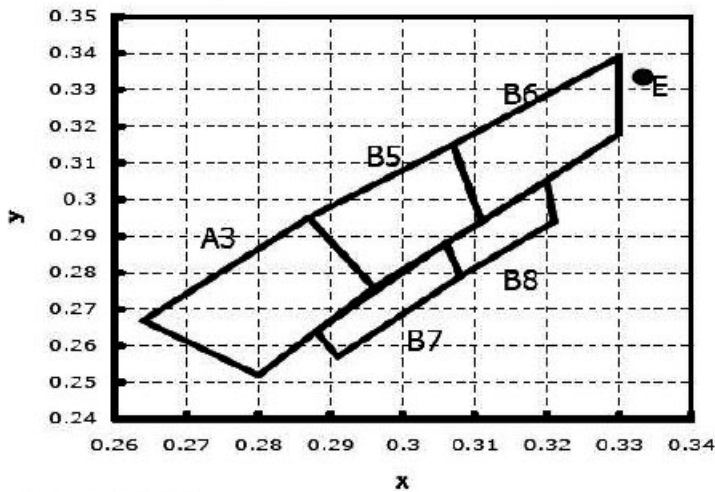

Color Ranks

Rank A3				Rank B5				Rank B7						
x	0.280	0.264	0.287	0.296	x	0.296	0.287	0.307	0.311	x	0.291	0.288	0.306	0.308
y	0.252	0.267	0.295	0.276	y	0.276	0.295	0.315	0.294	y	0.257	0.264	0.288	0.279

Rank B6				Rank B8					
x	0.311	0.307	0.330	0.330	x	0.308	0.288	0.32	0.321
y	0.294	0.315	0.339	0.318	y	0.279	0.264	0.305	0.294

* Color coordinates measurement allowance is ± 0.01

Typical Electrical/Optical Characteristics Curves (Ta=25° Unless Otherwise Noted)

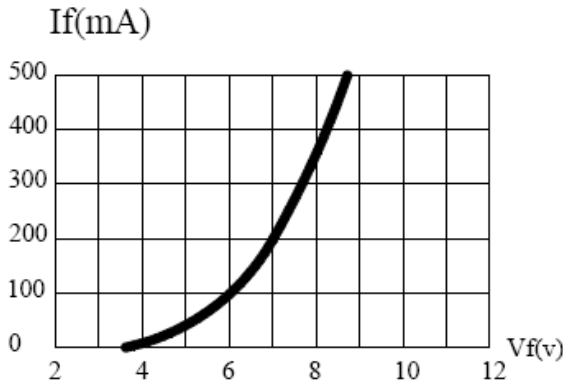

Fig. 1 Forward Current vs Forward Voltage

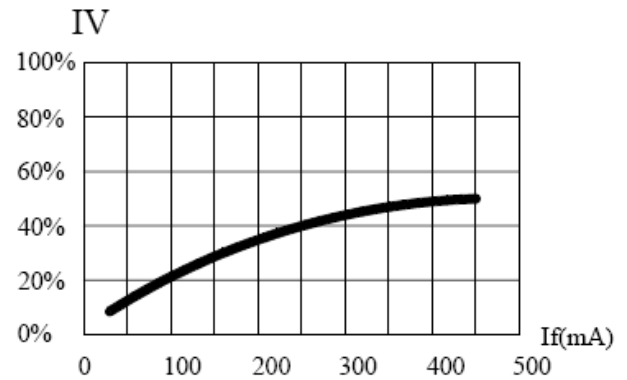

Fig. 2 Relative Luminous Flux vs Forward Current

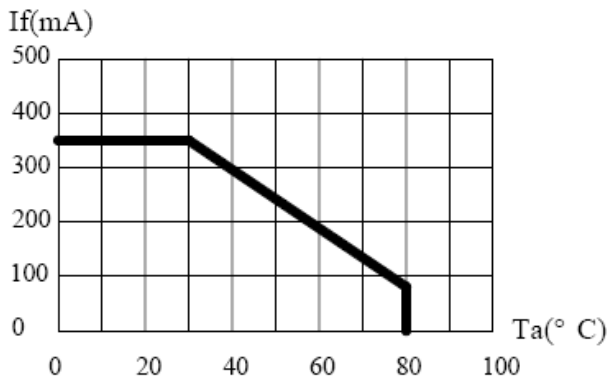

Fig. 3 Maximum Forward Current vs Ambient Temperature

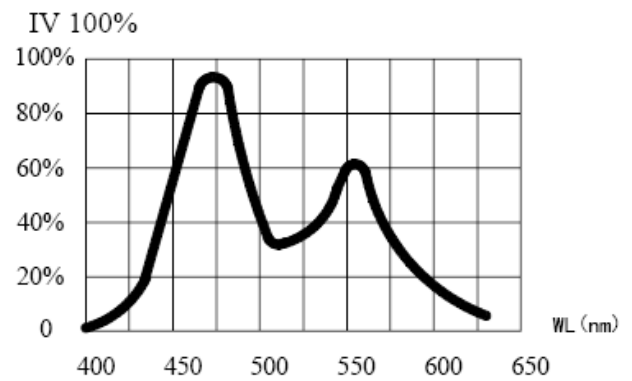

Fig. 4 Relative Luminous Flux vs Wavelength

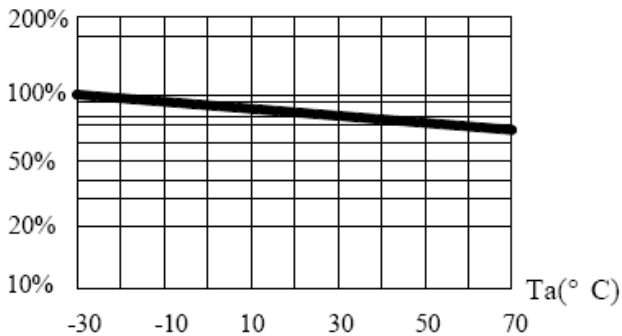

Fig. 5 Relative Luminous Flux vs Ambient Temperature

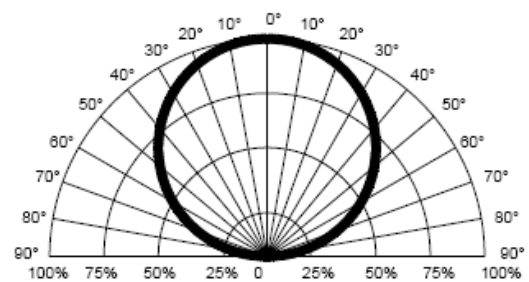
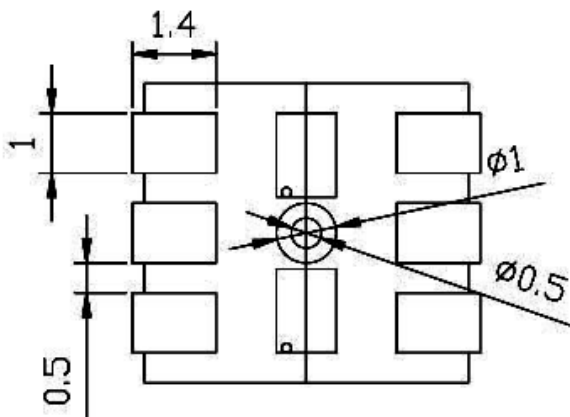
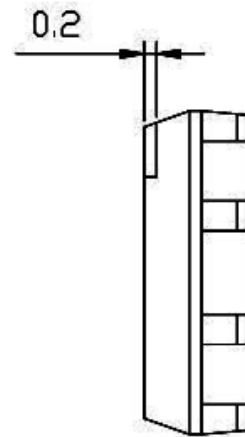
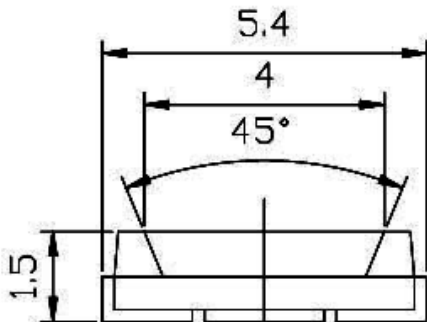
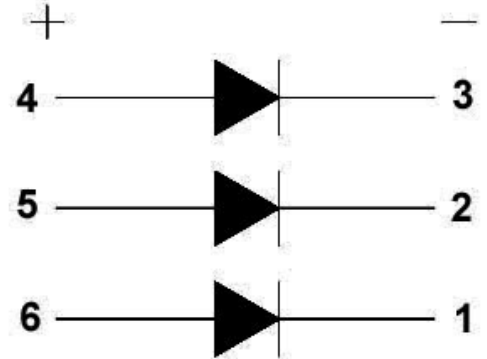
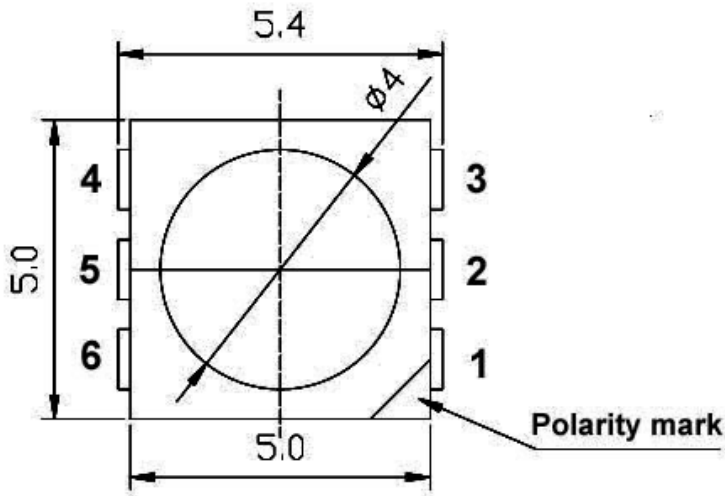

Fig. 6 Relative Luminous Flux vs Radiation Angle

Package Dimensions (unit:mm)



Copyright

Copyright 2009, by ShenZhen Wayjun Technology Co.,Ltd. All rights are reserved. ShenZhen Wayjun Technology Co.,Ltd reserves the right to make improvements to the products described in this manual at any time without notice.

Trademark

The names used for identification only may be registered trademarks of their respective companies.