



## MOS Controlled Diode

### PRODUCT SUMMARY

V <sub>RRM</sub>	I <sub>O</sub>	V <sub>F</sub> (MAX) @ 25°C	I <sub>R</sub> (MAX) @ 25°C
45V	8A	0.58V	0.5mA

### FEATURES

- Low Profile Design for Smart Phone Charger
- Ideal for SMT Mounting
- Low forward voltage drop
- High forward surge capability
- Excellent High Temperature Stability

### TO-277



Top View



Bottom View

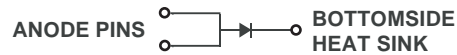

### ABSOLUTE MAXIMUM RATINGS (T<sub>A</sub>=25°C unless otherwise noted)

Symbol	Parameter	Value	Unit
V <sub>RRM</sub>	Peak Repetitive Reverse Voltage	45	V
V <sub>RWM</sub>	Working Peak Reverse Voltage	45	V
V <sub>RM</sub>	DC Blocking Voltage	45	V
V <sub>R(RMS)</sub>	RMS Reverse Voltage	32	V
I <sub>O</sub>	Average Rectified Output Current	8	A
I <sub>FSM</sub>	Non-Repetitive Peak Forward Surge Current 8.3ms Single Half Sine-Wave Superimposed on Rated Load	110	A
E <sub>AS</sub>	Non-Repetitive Avalanche Energy (T <sub>J</sub> = 25°C, I <sub>AS</sub> = 10, L = 5mH)	170	mJ
P <sub>ARM</sub>	Repetitive Peak Avalanche Energy	23000	W

### THERMAL CHARACTERISTICS

Symbol	Parameter	Value	Unit
R <sub>θJA</sub>	Thermal Resistance, Junction-to-Ambient	70	°C/W
T <sub>J</sub>	Operating Temperature Range	-55 to 150	°C
T <sub>STG</sub>	Storage Temperature Range	-55 to 175	°C

### ELECTRICAL CHARACTERISTICS (T<sub>A</sub>=25°C unless otherwise specified)

Symbol	Parameter	Conditions	Min	Typ	Max	Unit
V <sub>F</sub>	Forward Voltage Drop	I <sub>F</sub> = 5A, T <sub>J</sub> = 25°C		0.46	0.51	V
		I <sub>F</sub> = 8A, T <sub>J</sub> = 25°C		0.53	0.58	V
		I <sub>F</sub> = 8A, T <sub>J</sub> = 125°C		0.52	0.57	V
I <sub>R</sub>	Leakage Current	V <sub>R</sub> = 45V, T <sub>J</sub> = 25°C		90	500	uA
		V <sub>R</sub> = 45V, T <sub>J</sub> = 125°C			100	mA
C <sub>T</sub>	Total Capacitance	V <sub>R</sub> = 45V, f = 1MHz		85		pF

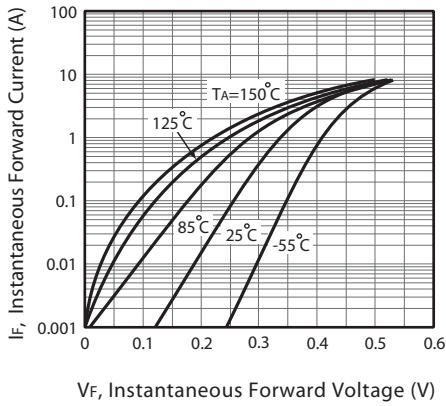

Figure 1. Typical Forward Characteristics

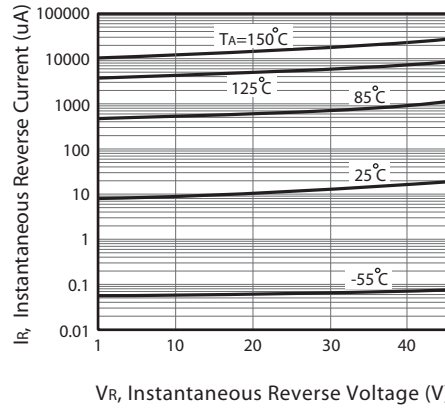

Figure 2. Typical Reverse Characteristics

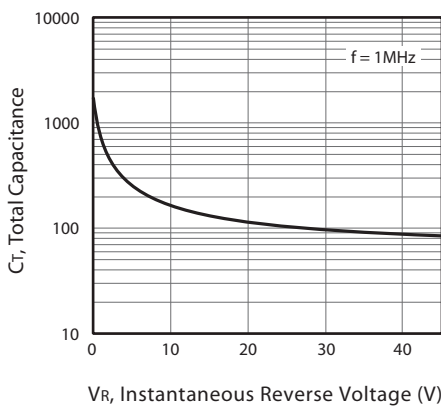

Figure 3. Total Capacitance vs. Reverse Voltage

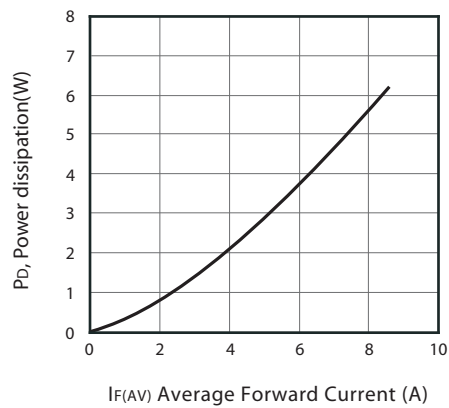

Figure 4. Forward Power Dissipation

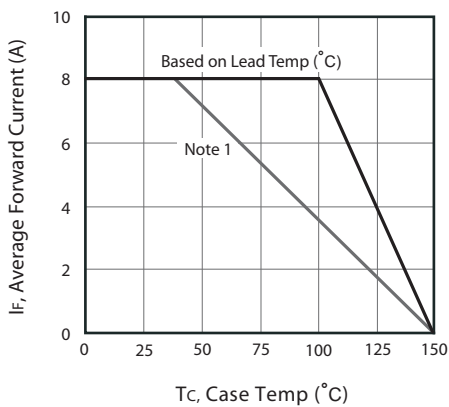

Figure 5. Forward Current Derating Curve

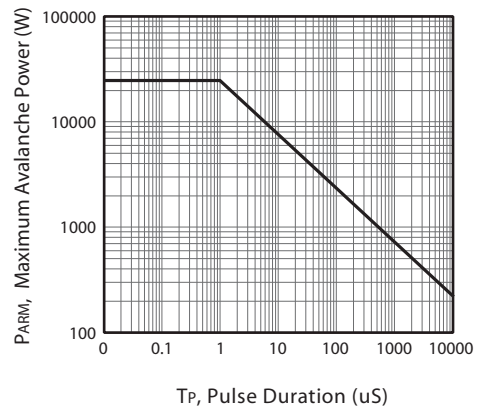

Figure 6. Maximum Avalanche Power Curve

**Note** : 1.Device mounted on FR-4 substrate, 2oz copper.

# SMD8L45SP

Ver 1.0

## PACKAGE OUTLINE DIMENSIONS

### TO-277

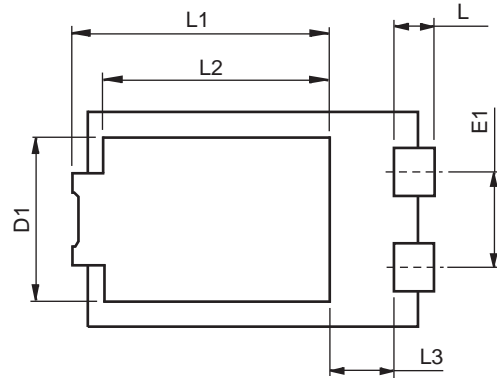
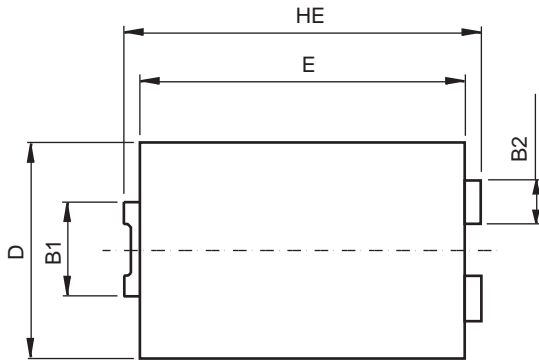

SYMBOLS	MILLIMETERS	
	MIN.	MAX.
HE	6.40	6.60
E	5.60	5.80
D	4.10	4.30
B1	1.70	1.90
B2	0.80	1.00
A	1.05	1.20
C	0.30	0.40
L	0.85	1.10
L1	4.20	4.40
L2	3.52 Typ.	
L3	1.10	1.40
D1	3.00	3.30
E1	1.86 Typ.	

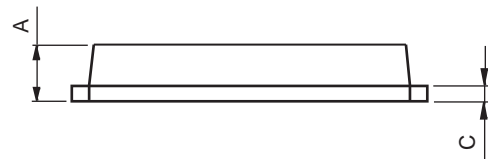

### Mounting Pad Layout (unit:mm)

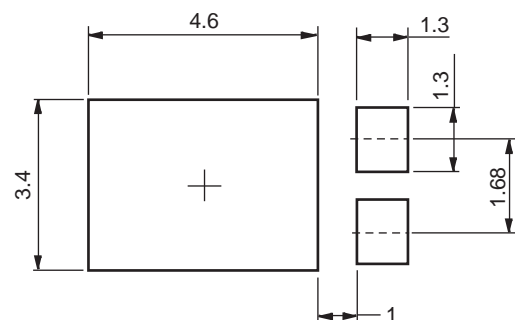

Dec,05,2014

# SMD8L45SP

## TOP MARKING DEFINITION

