

SMDT-50H

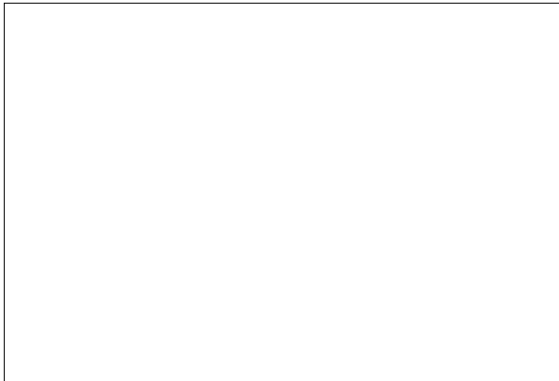

Diode-Thyristor Module



Type	V_{RSM}	V_{RRM} , V_{DRM}
SMDT-50H-08	1000	800
SMDT-50H-12	1400	1200
SMDT-50H-14	1600	1400
SMDT-50H-16	1800	1600
SMDT-50H-18	2000	1800
SMDT-50H-20	2200	2000
SMDT-50H-22	2400	2200
SMDT-50H-24	2600	2400

www.DataSheet4U.com

Type	I_{TAVM} , I_{FAVM}	I_{TRMS} , I_{FRMS}	T_c	I_{TSM} , I_{FSM}	$(di/dt)_{cr}$	$(dv/dt)_{cr}$	V_{TM}	I_{TM} , I_{FM}	V_{TO}	r_T	t_q	V_{GT}	I_{GT}	T_{VJM}	V_{isol}	R_{thJC}
	A	A	°C	kA	A/μs	V/μs	V	A	V	mΩ	μs	V	mA	°C	V	K/W
SMDT-50H	55	100	85	1.3	50	800	1.50	170	0.85	4.9	150	2.5	100	125	2500	0.53

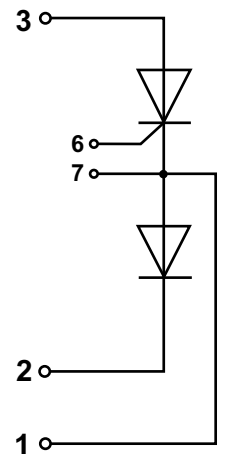
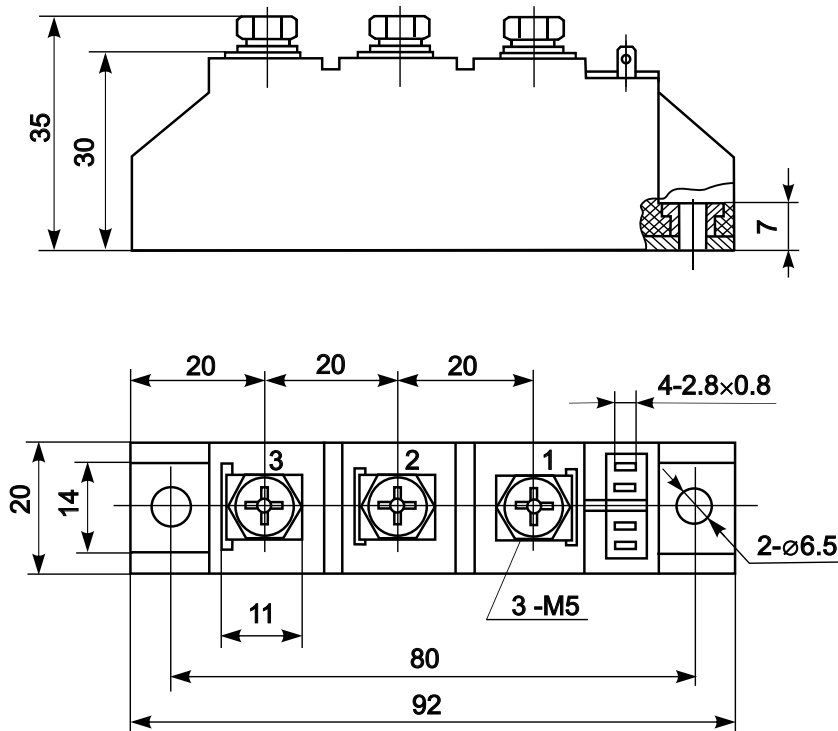

Features:

- Industrial standard package
- Heat transfer through aluminium nitride ceramic isolated metal baseplate
- Precise internal pressure contacts for high reliability
- 2500V RMS isolation voltage

Typical Applications:

- DC motor control
- AC motor soft starter
- Temperature control (e.g. for ovens, chemical processes)
- Lighting control