



SMF5.0A~SMF175A

SURFACE MOUNT TRANSIENT VOLTAGE SUPPRESSOR

VOLTAGE 5 to 175 Volt **POWER** 200 Watt

SOD-123FL Unit : inch(mm)

FEATURES

- For surface mounted applications in order to optimize board space.
- Ultra Thin Profile Package for Space Constrained Utilization
- Package suitable for Automated Handling
- Low inductance
- High temperature soldering : 260°C/10 seconds at terminals
- ESD IEC-61000-4-2 Air ± 30kV, Contact ± 30kV
- Lead free in compliance with EU RoHS 2011/65/EU directive
- Green molding compound as per IEC61249 Std. . (Halogen Free)

MECHANICAL DATA

- Case: SOD-123FL, Plastic
- Terminals: Solderable per MIL-STD-750, Method 2026
- Polarity: Color band denotes cathode end
- Weight: 0.0006 ounce, 0.0173 gram
- Standard Packaging: 8mm tape (EIA-481)

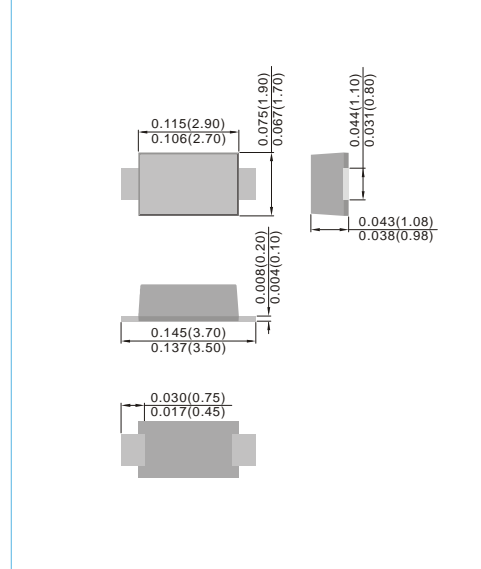
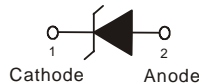

MAXIMUM RATINGS AND ELECTRICAL CHARACTERISTICS (T_A=25°C unless otherwise noted)

PARAMETER	SYMBOL	VALUE	UNITS
Peak Pulse Power Dissipation on T _A = 25°C (Notes 1,2,5, Fig.1)	P _{PPM}	200	W
Peak Forward Surge Current per (Notes 3)	I _{FSM}	20	A
Peak Pulse Current on tp=10/1000µs waveform (Notes 1) Fig.2	I _{PPM}	see Table 1	A
Steady State Power Dissipation (Notes 4)	P _{M(AV)}	1	W
ESD IEC-61000-4-2 (Air) ESD IEC-61000-4-2 (Contact)	V _{ESD}	±30 ±30	kV
Operating Junction and Storage Temperature Range	T _J , T _{STG}	-55 to +150	°C
Typical thermal resistance	R _{θJA}	180	°C

NOTES :

1. Non-repetitive current pulse, per Fig.3 and derated above T_A=25°C per Fig.2 .
2. Mounted on 5mm² copper pads to each terminal.
3. 8.3ms single half sine-wave, or equivalent square wave, duty cycle = 4 pulses per minutes maximum.
4. Lead temperature at 75°C =T_L .
5. Peak pulse power waveform is tp=10/1000µs.
6. A transient suppressor is selected according to the working peak reverse voltage(V_{RWM}), which should be equal to or greater than the DC or continuous peak operating voltage level.



SMF5.0A~SMF175A

Part Number	V _{RWM} (Note 6)	V _{BR} @ I _T			I _r @ V _{RWM}	V _C @ I _{PP}		Marking Code
		Min.	Max.	I _T		V	A	
	V	V	mA	μA				
200W Transient Voltage Suppressor								
SMF5.0A	5	6.4	7	10	200	9.2	21.7	HE
SMF6.0A	6	6.7	7.4	10	100	10.3	19.4	HG
SMF6.5A	6.5	7.2	8	10	75	11.2	17.9	HK
SMF7.0A	7	7.8	8.6	10	50	12	16.7	HM
SMF7.5A	7.5	8.3	9.2	1	50	12.9	15.5	HP
SMF8.0A	8	8.9	9.8	1	25	13.6	14.7	HR
SMF8.5A	8.5	9.4	10.4	1	10	14.4	13.9	HT
SMF9.0A	9	10	11.1	1	5	15.4	13	HV
SMF10A	10	11.1	12.3	1	2.5	17	11.8	HX
SMF11A	11	12.2	13.5	1	2.5	18.2	11	HZ
SMF12A	12	13.3	14.7	1	2.5	19.9	10.1	IE
SMF13A	13	14.4	15.9	1	1	21.5	9.3	IG
SMF14A	14	15.6	17.2	1	1	23.2	8.6	IK
SMF15A	15	16.7	18.5	1	1	24.4	8.2	IM
SMF16A	16	17.8	19.7	1	1	26	7.7	IP
SMF17A	17	18.9	20.9	1	1	27.6	7.2	IR
SMF18A	18	20	22.1	1	1	29.2	6.8	IT
SMF20A	20	22.2	24.5	1	1	32.4	6.2	IV
SMF22A	22	24.4	26.9	1	1	35.5	5.6	IX
SMF24A	24	26.7	29.5	1	1	38.9	5.1	IZ
SMF26A	26	28.9	31.9	1	1	42.1	4.8	JE
SMF28A	28	31.1	34.4	1	1	45.4	4.4	JG
SMF30A	30	33.3	36.8	1	1	48.4	4.1	JK
SMF33A	33	36.7	40.6	1	1	53.3	3.8	JM
SMF36A	36	40	44.2	1	1	58.1	3.4	JP
SMF40A	40	44.4	49.1	1	1	64.5	3.1	JR
SMF43A	43	47.8	52.8	1	1	69.4	2.9	JT
SMF45A	45	50	55.3	1	1	72.7	2.8	JV
SMF48A	48	53.3	58.9	1	1	77.4	2.6	JX
SMF51A	51	56.7	62.7	1	1	82.4	2.4	JZ
SMF54A	54	60	66.3	1	1	87.1	2.3	RE
SMF58A	58	64.4	71.2	1	1	93.6	2.1	RG
SMF60A	60	66.7	73.7	1	1	96.8	1.8	RK
SMF64A	64	71.1	78.6	1	1	103	1.7	RM
SMF70A	70	77.8	86	1	1	113	1.5	RP
SMF75A	75	83.3	92.1	1	1	121	1.4	RR
SMF78A	78	86.7	95.8	1	1	126	1.4	RT
SMF85A	85	94.4	104	1	1	137	1.3	RV
SMF90A	90	100	111	1	1	146	1.2	RX
SMF100A	100	111	123	1	1	162	1.1	RZ
SMF110A	110	122	135	1	1	177	1	SE
SMF120A	120	133	147	1	1	193	0.9	SG
SMF130A	130	144	159	1	1	209	0.8	SK
SMF150A	150	167	185	1	1	243	0.7	SM
SMF160A	160	178	197	1	1	259	0.7	SP
SMF170A	170	189	209	1	1	275	0.6	SR
SMF175A	175	198	214	1	1	284	0.6	S5



SMF5.0A~SMF175A

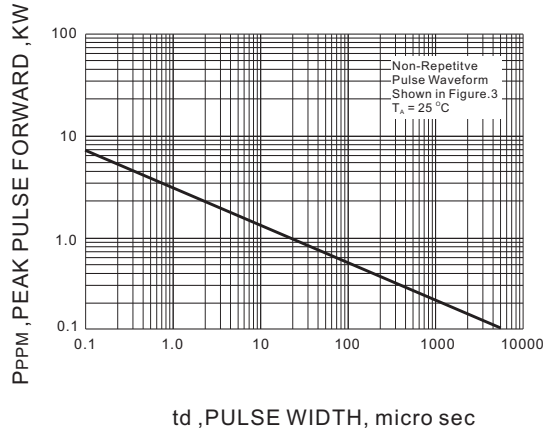

Fig.1 PEAK PULSE POWER RATING CURVE

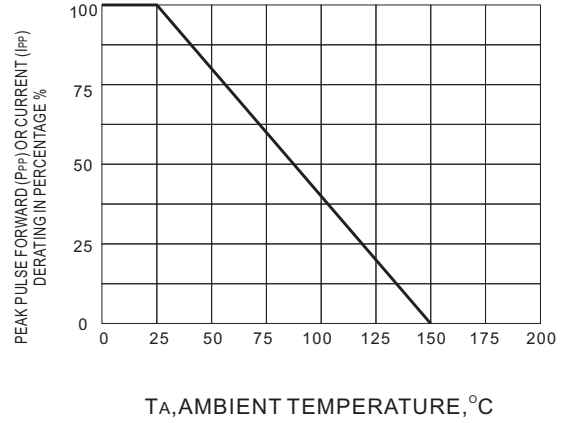

Fig.2 DERATING CURVE

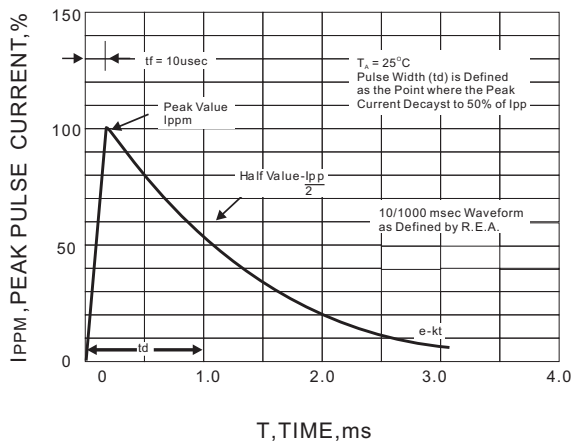

Fig.3 PULSE WAVEFORM

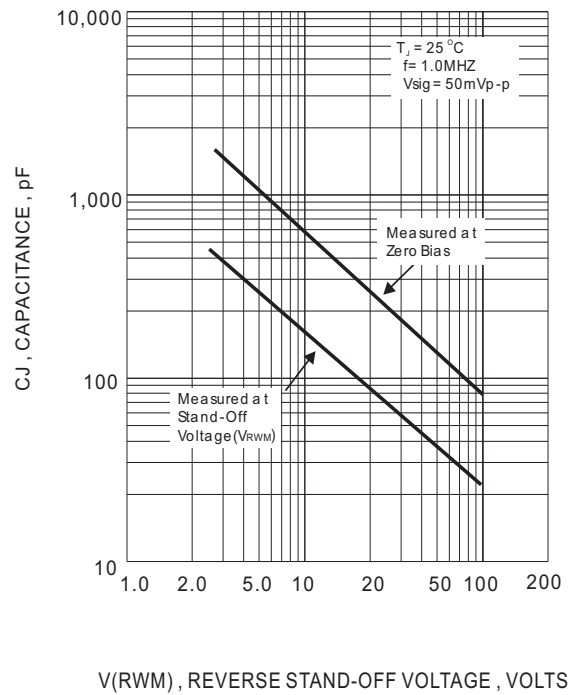

Fig.4 TYPICAL JUNCTION CAPACITANCE

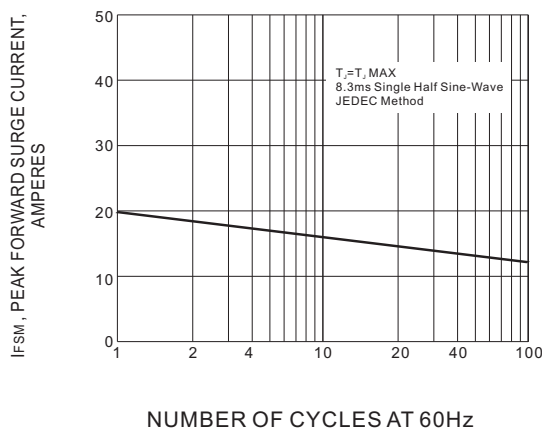

Fig.5 MAXIMUM NON-REPETITIVE PEAK FORWARD SURGE CURRENT



SMF5.0A~SMF175A

PART NO PACKING CODE VERSION

Part No Packing Code	Package Type	Packing Type	Marking	Version
SMF5.0A_R1_00001	SOD-123FL	3K pcs / 7" reel	HE	Halogen free
SMF5.0A_R1_00001	SOD-123FL	10K pcs / 13" reel	HE	Halogen free

MOUNTING PAD LAYOUT

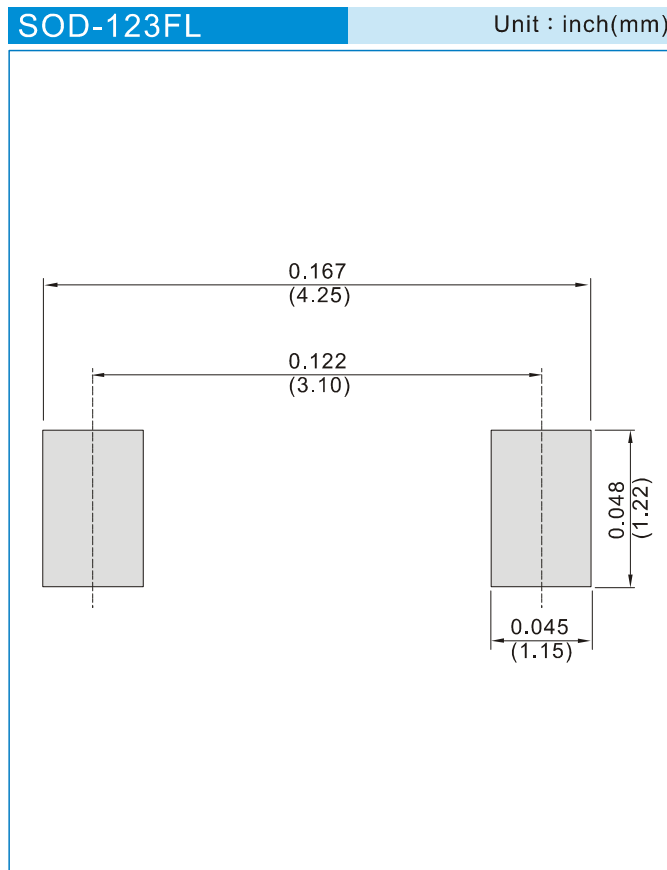



SMF5.0A~SMF175A

Disclaimer

- Reproducing and modifying information of the document is prohibited without permission from Panjit International Inc..
- Panjit International Inc. reserves the rights to make changes of the content herein the document anytime without notification. Please refer to our website for the latest document.
- Panjit International Inc. disclaims any and all liability arising out of the application or use of any product including damages incidentally and consequentially occurred.
- Panjit International Inc. does not assume any and all implied warranties, including warranties of fitness for particular purpose, non-infringement and merchantability.
- Applications shown on the herein document are examples of standard use and operation. Customers are responsible in comprehending the suitable use in particular applications. Panjit International Inc. makes no representation or warranty that such applications will be suitable for the specified use without further testing or modification.
- The products shown herein are not designed and authorized for equipments requiring high level of reliability or relating to human life and for any applications concerning life-saving or life-sustaining, such as medical instruments, transportation equipment, aerospace machinery et cetera. Customers using or selling these products for use in such applications do so at their own risk and agree to fully indemnify Panjit International Inc. for any damages resulting from such improper use or sale.
- Since Panjit uses lot number as the tracking base, please provide the lot number for tracking when complaining.