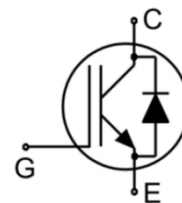

**Main Product Characteristics:**

$V_{CES}$	1250V
$I_C$	40A
$V_{CE(sat)}$	1.75V

**TO-247**

**Schematic Diagram**
**Features and Benefits:**

- Trench FS technology offering
- High speed switching
- Low gate charge and  $V_{CE(sat)}$
- High ruggedness, temperature stable behavior
- Maximum junction temperature 175°C

**Applications:**

- Solar Inverters
- Uninterruptible power supplies
- Motor drives
- Air condition

**Absolute Max Rating:**

Symbol	Parameter	Value	Units
$V_{CES}$	Collector-Emitter Voltage	1250	V
$V_{GES}$	Gate- Emitter Voltage	$\pm 30$	V
$I_C$	Collector Current	80	A
	Collector Current @ $T_c = 100\text{ }^\circ\text{C}$	40	
$I_{Cpuls}$	Pulsed Collector Current, $t_p$ limited by $T_{Jmax}$	160	
-	Turn off safe operating area, $V_{CE}=1200V$ , $T_J=175^\circ\text{C}$	160	
$I_F$	Diode Continuous Forward Current @ $T_c = 100\text{ }^\circ\text{C}$	40	
$I_{FM}$	Diode Maximum Forward Current	160	
$P_D$	Power Dissipation @ $T_c = 25^\circ\text{C}$	600	W
$T_J$ $T_{STG}$	Operating Junction and Storage Temperature Range	-55 to +175	$^\circ\text{C}$
$T_L$	Maximum Temperature for Soldering	260	$^\circ\text{C}$

**Thermal Resistance**

Symbol	Characterizes	Typ.	Max.	Units
R <sub>θJC</sub>	Thermal Resistance, Junction-to-case for IGBT	—	0.25	°C/W
	Thermal Resistance, Junction-to-case for Diode	—	0.63	°C/W
R <sub>θJA</sub>	Thermal Resistance, Junction-to-ambient	—	40	°C/W

**Electrical Characteristics @T<sub>A</sub>=25°C unless otherwise specified**

Symbol	Parameter	Min.	Typ.	Max.	Units	Conditions
V <sub>(BR)CES</sub>	Collector-Emitter Breakdown Voltage	1250	—	—	V	V <sub>GE</sub> =0V, I <sub>CE</sub> =1mA
V <sub>CE(sat)</sub>	Collector-Emitter Saturation Voltage	—	1.75	2	V	I <sub>C</sub> =40A, V <sub>GE</sub> =15V @T <sub>J</sub> =25°C
V <sub>GE(th)</sub>	Gate Threshold Voltage	4.5	—	6.5	V	I <sub>C</sub> =1mA, V <sub>CE</sub> =V <sub>GE</sub>
I <sub>CES</sub>	Collector-Emitter Leakage Current	—	—	1	μA	V <sub>GE</sub> =0V, V <sub>CE</sub> =1200V
I <sub>GES</sub>	Gate to Emitter Reverse Leakage	—	—	200	nA	V <sub>GE</sub> =25V, V <sub>CE</sub> =0V
		—	—	-200		V <sub>GE</sub> =-25V, V <sub>CE</sub> =0V
C <sub>ies</sub>	Input capacitance	—	4803	—	pF	V <sub>GS</sub> = 0V V <sub>DS</sub> = 25V f = 1MHz
C <sub>oes</sub>	Output capacitance	—	171	—		
C <sub>res</sub>	Reverse transfer capacitance	—	92	—		
t <sub>d(on)</sub>	Turn-on delay time	—	40	—	ns	V <sub>CC</sub> =600V, V <sub>GE</sub> =0.0/15.0V, R <sub>G</sub> =10.0Ω
t <sub>r</sub>	Rise time	—	22	—		
t <sub>d(off)</sub>	Turn-Off delay time	—	358	—		
t <sub>f</sub>	Fall time	—	47	—		
E <sub>on</sub>	Turn-On Switching Loss	—	2.29	—	mJ	V <sub>CC</sub> =600V, V <sub>GE</sub> =0.0/15.0V, R <sub>G</sub> =10.0Ω
E <sub>off</sub>	Turn-Off Switching Loss	—	1.74	—		
E <sub>is</sub>	Total Switching Loss	—	4.03	—		
Q <sub>g</sub>	Total Gate Charge	—	235	—	nC	V <sub>CC</sub> =480V, I <sub>C</sub> =40A, V <sub>GE</sub> =15V
Q <sub>ge</sub>	Gate to Emitter Charge	—	40	—		
Q <sub>gc</sub>	Gate to Collector Charge	—	133	—		
I <sub>C(SC)</sub>	Short circuit collector current Max.1000 short circuits Time between short circuits: ≥1.0s	—	400	—	A	V <sub>GE</sub> =15V, V <sub>CC</sub> ≤600V, t <sub>sc</sub> ≤10μs

**Electrical Characteristics of the Diode @T<sub>A</sub>=25°C unless otherwise specified**

Symbol	Parameter	Min.	Typ.	Max.	Units	Conditions
V <sub>FM</sub>	Diode Forward Voltage	—	2.3	3	V	I <sub>F</sub> =40A, V <sub>GE</sub> =0V
t <sub>rr</sub>	Reverse Recovery Time	—	223	—	ns	T <sub>J</sub> = 25°C, I <sub>F</sub> =40A, V <sub>GE</sub> =0.0/15.0V, V <sub>R</sub> =600V
Q <sub>rr</sub>	Reverse Recovery Charge	—	2.99	—	μC	
I <sub>RRM</sub>	Diode Peak Reverse Recovery Current	—	34.5	—	A	

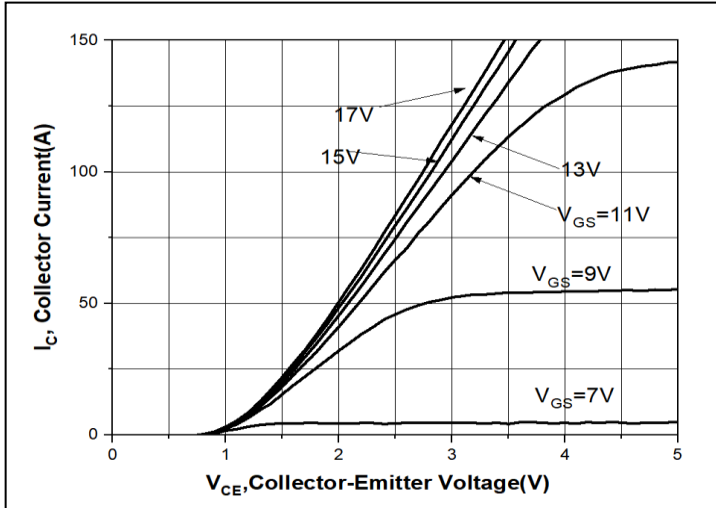
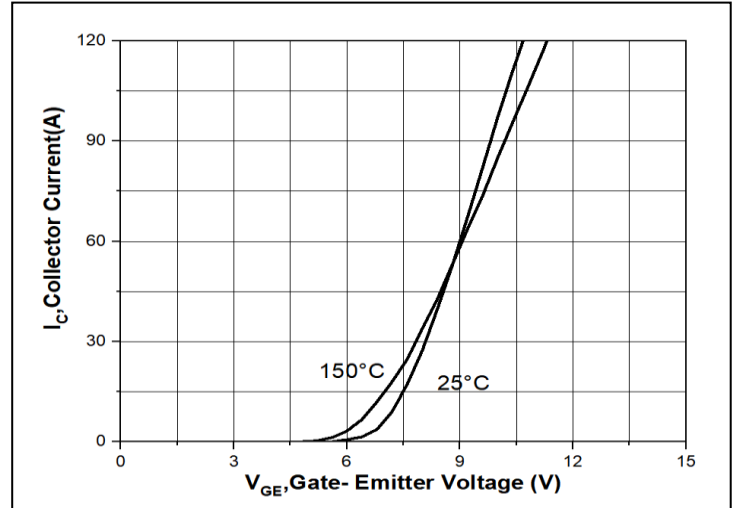
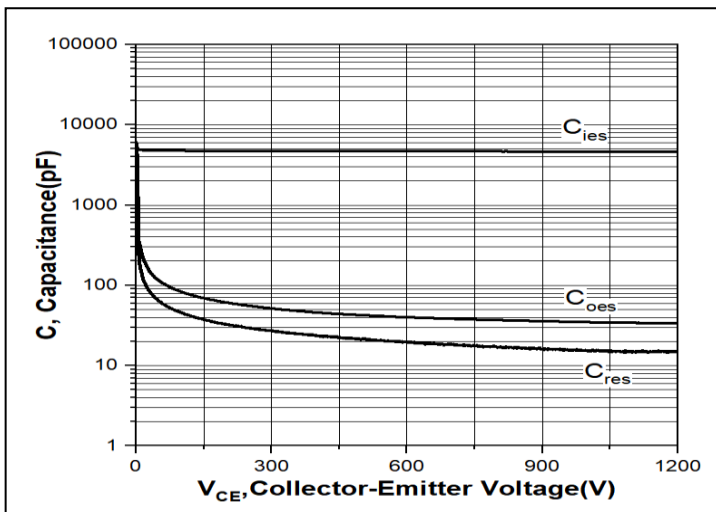
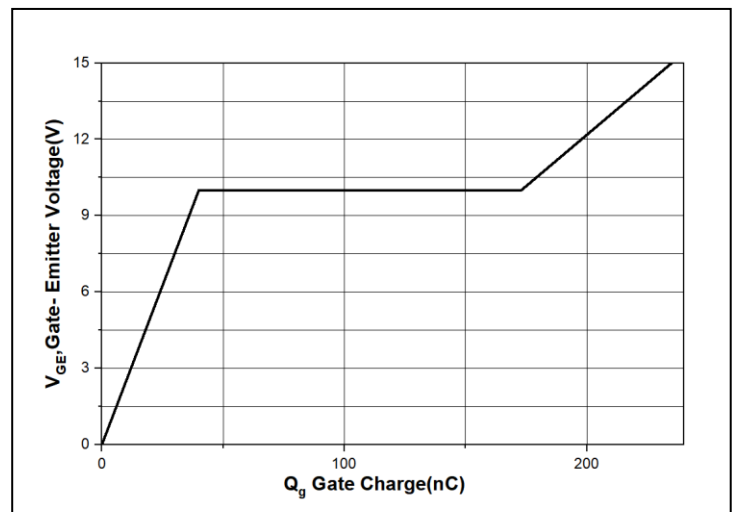
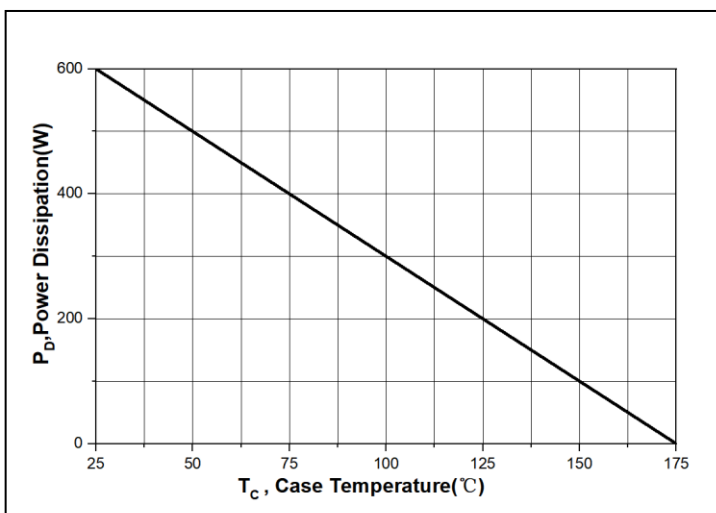
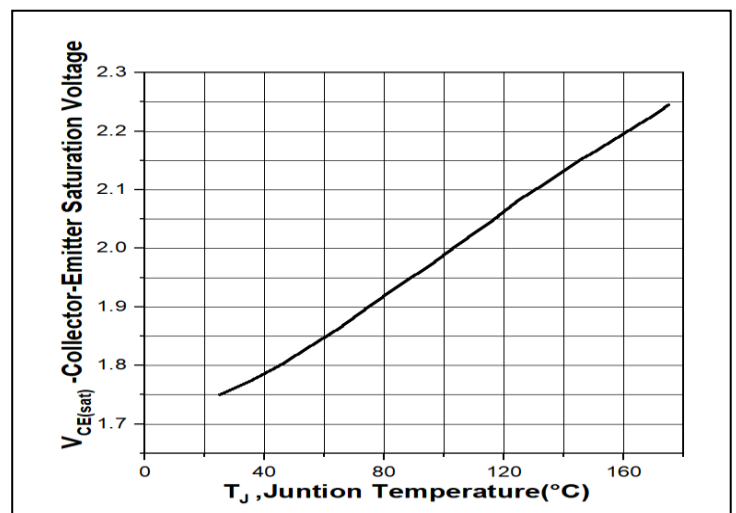
**Typical Electrical and Thermal Characteristics**

**Figure1. Typical Output Characteristics**

**Figure2. Typical Transfer Characteristics**

**Figure3. Typical Capacitance**

**Figure4. Typical Gate Charge**

**Figure5. Power Dissipation vs. Case Temperature**

**Figure6. Collector-Emmitter Saturation Voltage vs. Temperature**

Typical Electrical and Thermal Characteristics

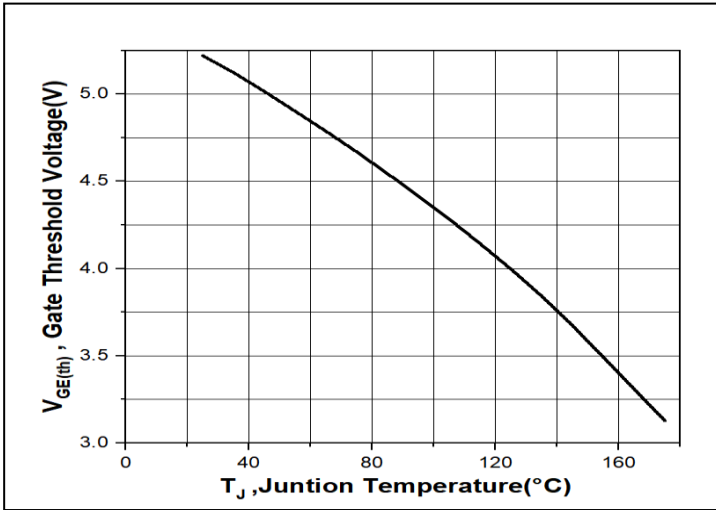

Figure7. Gate Threshold Voltage vs. Temperature

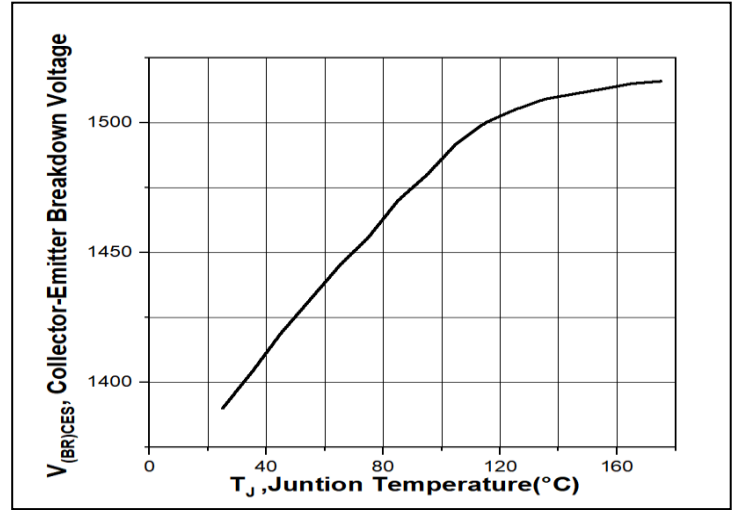

Figure8. Collector-Emitter Breakdown Voltage vs. Temperature

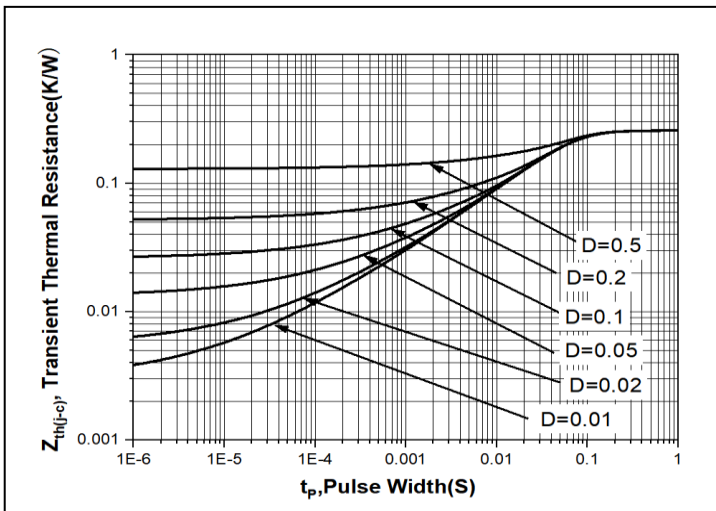

Figure9. IGBT transient thermal resistance (D= t<sub>p</sub>/T)

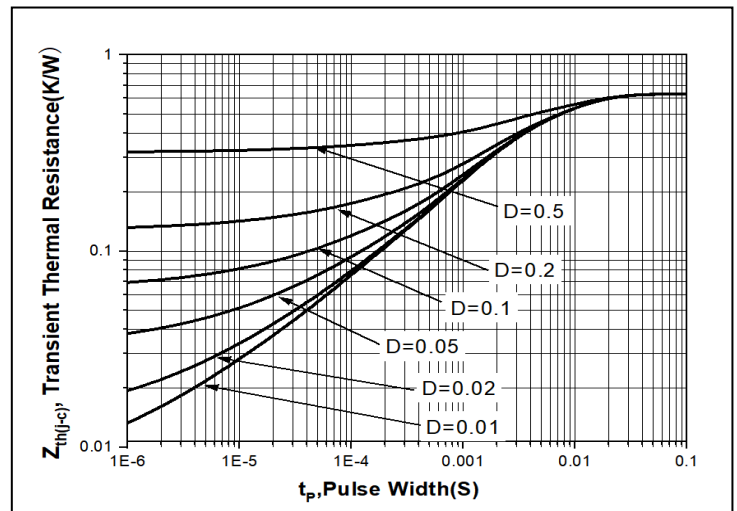
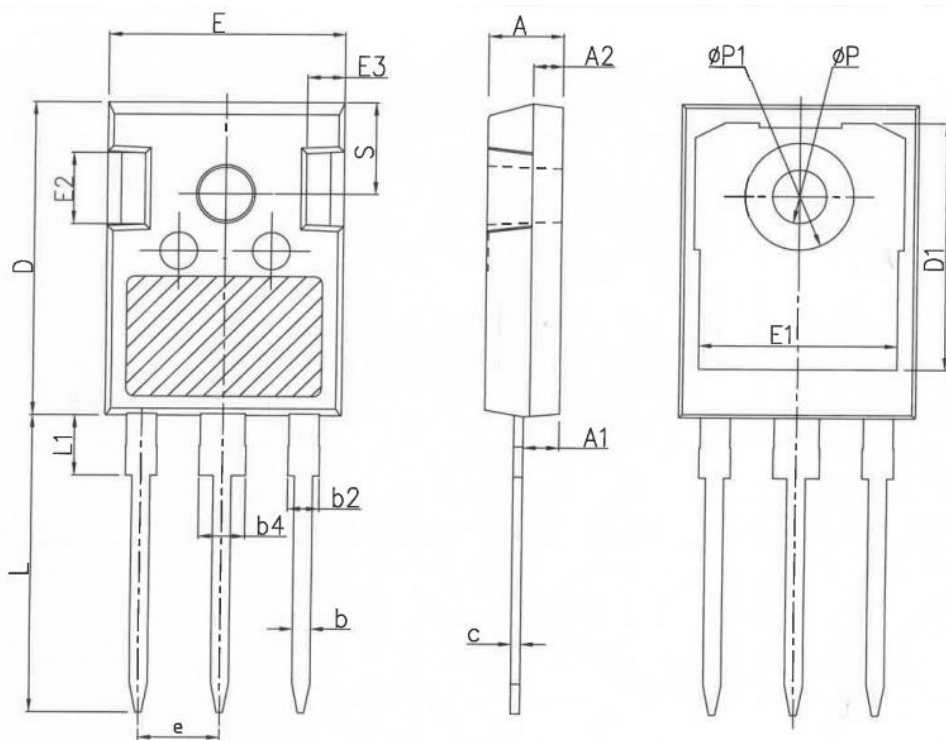

Figure10. Diode transient thermal impedance as a function of pulse width (D=t<sub>p</sub>/T)

**Mechanical Data:**

**COMMON DIMENSIONS**

SYMBOL	mm		
	MIN	NOM	MAX
A	4.80	5.00	5.20
A1	2.21	2.41	2.59
A2	1.85	2.00	2.15
b	1.11	1.21	1.36
b2	1.91	2.01	2.21
b4	2.91	3.01	3.21
c	0.51	0.61	0.75
D	20.70	21.00	21.30
D1	16.25	16.55	16.85
E	15.50	15.80	16.10
E1	13.00	13.30	13.60
E2	4.80	5.00	5.20
E3	2.30	2.50	2.70
e	5.44BSC		
L	19.62	19.92	20.22
L1	-	-	4.30
ΦP	3.40	3.60	3.80
ΦP1	-	-	7.30
S	6.15BSC		

---

**ATTENTION:**

- Any and all Silikron products described or contained herein do not have specifications that can handle applications that require extremely high levels of reliability, such as life-support systems, aircraft's control systems, or other applications whose failure can be reasonably expected to result in serious physical and/or material damage. Consult with your Silikron representative nearest you before using any Silikron products described or contained herein in such applications.
- Silikron assumes no responsibility for equipment failures that result from using products at values that exceed, even momentarily, rated values (such as maximum ratings, operating condition ranges, or other parameters) listed in products specifications of any and all Silikron products described or contained herein.
- Specifications of any and all Silikron products described or contained herein stipulate the performance, characteristics, and functions of the described products in the independent state, and are not guarantees of the performance, characteristics, and functions of the described products as mounted in the customer's products or equipment. To verify symptoms and states that cannot be evaluated in an independent device, the customer should always evaluate and test devices mounted in the customer's products or equipment.
- Silikron Microelectronics (Suzhou) Co.,Ltd. strives to supply high-quality high-reliability products. However, any and all semiconductor products fail with some probability. It is possible that these probabilistic failures could give rise to accidents or events that could endanger human lives, that could give rise to smoke or fire, or that could cause damage to other property. When designing equipment, adopt safety measures so that these kinds of accidents or events cannot occur. Such measures include but are not limited to protective circuits and error prevention circuits for safe design, redundant design, and structural design.
- In the event that any or all Silikron products(including technical data, services) described or contained herein are controlled under any of applicable local export control laws and regulations, such products must not be exported without obtaining the export license from the authorities concerned in accordance with the above law.
- No part of this publication may be reproduced or transmitted in any form or by any means, electronic or mechanical, including photocopying and recording, or any information storage or retrieval system, or otherwise, without the prior written permission of Silikron Microelectronics (Suzhou) Co.,Ltd.
- Information (including circuit diagrams and circuit parameters) herein is for example only ; it is not guaranteed for volume production. Silikron believes information herein is accurate and reliable, but no guarantees are made or implied regarding its use or any infringements of intellectual property rights or other rights of third parties.
- Any and all information described or contained herein are subject to change without notice due to product/technology improvement, etc. When designing equipment, refer to the "Delivery Specification" for the Silikron product that you intend to use.