

RoHS Compliant Product

Description

The SMG2305 provide the designer with the best combination of fast switching, low on-resistance and cost-effectiveness.

The SMG2305 is universally preferred for all commercial industrial surface mount application and suited for low voltage applications such as DC/DC converters.

Features

- * Super high dense cell design for extremely low $R_{DS(ON)}$
- * Reliable and rugged

Applications

- * Power Management in Notebook Computer
- * Portable Equipment
- * Battery Powered System

Marking : 2305

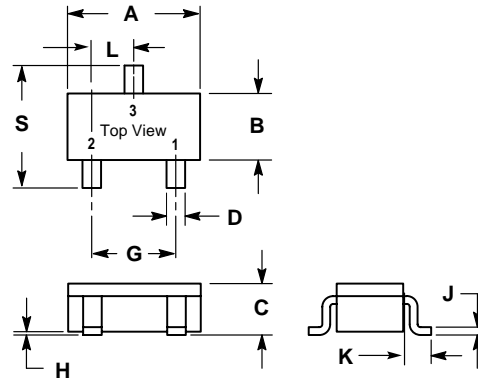

SC-59		
Dim	Min	Max
A	2.70	3.10
B	1.40	1.60
C	1.00	1.30
D	0.35	0.50
G	1.70	2.10
H	0.00	0.10
J	0.10	0.26
K	0.20	0.60
L	0.85	1.15
S	2.40	2.80
All Dimension in mm		

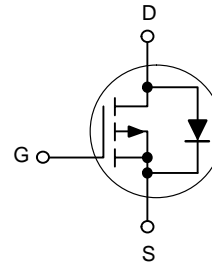
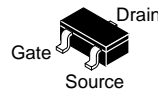

Absolute Maximum Ratings

Parameter	Symbol	Ratings	Unit
Drain-Source Voltage	V_{DS}	-20	V
Gate-Source Voltage	V_{GS}	± 12	V
Continuous Drain Current ³	$I_D @ T_A=25^\circ C$	-4.2	A
Continuous Drain Current ³	$I_D @ T_A=70^\circ C$	-3.4	A
Pulsed Drain Current	I_{DM}	-10	A
Total Power Dissipation	$P_D @ T_A=25^\circ C$	1.38	W
Linear Derating Factor		0.01	W/ $^\circ C$
Operating Junction and Storage Temperature Range	T_j, T_{stg}	-55~+150	$^\circ C$

Thermal Data

Parameter	Symbol	Ratings	Unit
Thermal Resistance Junction-ambient ³	R_{thj-a}	90	$^\circ C/W$

Electrical Characteristics(T_j=25°C Unless otherwise specified)

Parameter	Symbol	Min.	Typ.	Max.	Unit	Test Condition
Drain-Source Breakdown Voltage	BV _{DSS}	-20	-	-	V	V _{GS} =0V, I _D =-250uA
Breakdown Voltage Temp. Coefficient	ΔBV _{DSS} /ΔT _j	-	-0.1	-	V/	Reference to 25°C, I _D =-1mA
Gate Threshold Voltage	V _{GS(th)}	-0.5	-	-	V	V _{DS} =V _{GS} , I _D =-250uA
Gate-Source Leakage Current	I _{GSS}	-	-	±100	nA	V _{GS} =±12V
Drain-Source Leakage Current (T _j =25°C)	I _{DSS}	-	-	-1	uA	V _{DS} =-20V, V _{GS} =0
Drain-Source Leakage Current (T _j =70°C)		-	-	-10	uA	V _{DS} =-16V, V _{GS} =0
Static Drain-Source On-Resistance ²	R _{DS(ON)}	-	-	53	mΩ	V _{GS} =-10V, I _D =-4.5A
		-	-	65		V _{GS} =-4.5V, I _D =-4.2A
		-	-	100		V _{GS} =-2.5V, I _D =-2A
		-	-	250		V _{GS} =-1.8V, I _D =-1A
Total Gate Charge ²	Q _g	-	10.6	-	nC	I _D =-4.2A V _{DS} =-16V V _{GS} =-4.5V
Gate-Source Charge	Q _{gs}	-	2.32	-		
Gate-Drain ("Miller") Charge	Q _{gd}	-	3.68	-		
Turn-on Delay Time ²	T _{d(ON)}	-	5.9	-	nS	V _{DS} =-15V I _D =-4.2A V _{GS} =-10V R _G =6Ω R _D =3.6Ω
Rise Time	T _r	-	3.6	-		
Turn-off Delay Time	T _{d(OFF)}	-	32.4	-		
Fall Time	T _f	-	2.6	-		
Input Capacitance	C _{iss}	-	740	-	pF	V _{GS} =0V V _{DS} =-15V f=1.0MHz
Output Capacitance	C _{oss}	-	167	-		
Reverse Transfer Capacitance	C _{rss}	-	126	-		
Forward Transconductance	G _{fs}	-	9	-	S	V _{DS} =-5V, I _D =-2.8A

Source-Drain Diode

Parameter	Symbol	Min.	Typ.	Max.	Unit	Test Condition
Forward On Voltage ²	V _{SD}	-	-	-1.2	V	I _S =-1.2A, V _{GS} =0V.
Reverse Recovery Time	T _{rr}	-	27.7	-	nS	I _S =-4.2A, V _{GS} =0V dI/dt=100A/uS
Reverse Recovery Charge	Q _{rr}	-	22	-	nC	

Notes: 1.Pulse width limited by Max. junction temperature.

2.Pulse width ≤300us, dutycycle≤2%.

3.Surface mounted on 1 inch² copper pad of FR4 board; 270°C/W when mounted on min. copper pad.

Characteristics Curve

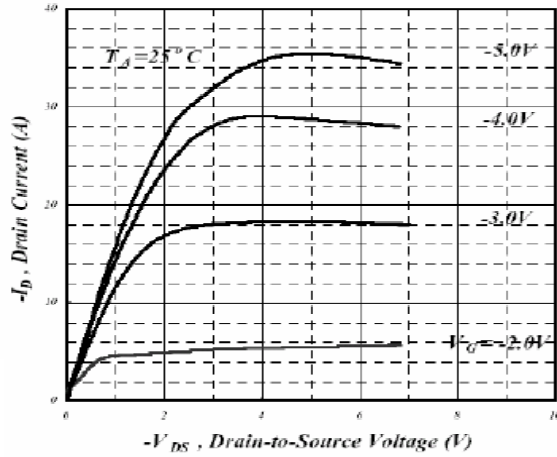

Fig 1. Typical Output Characteristics

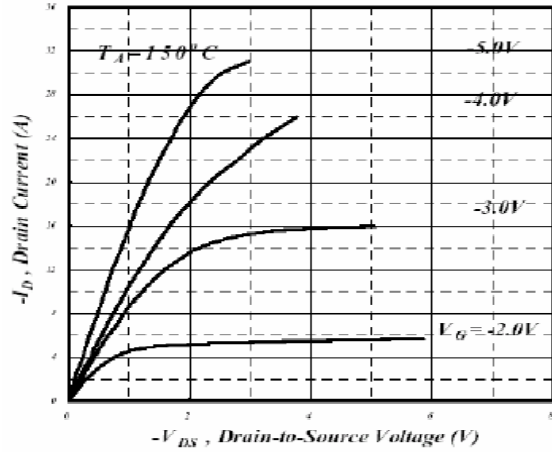

Fig 2. Typical Output Characteristics

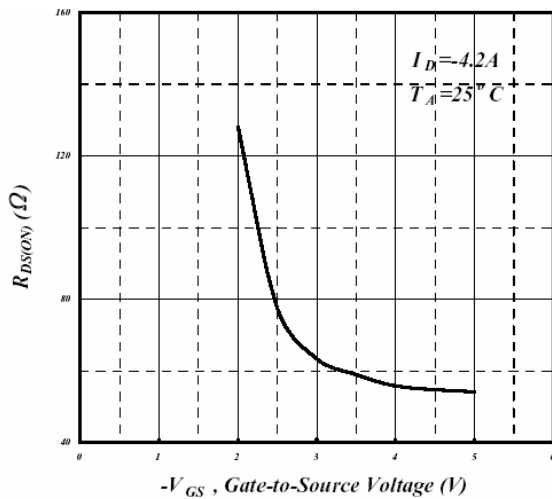

Fig 3. On-Resistance v.s. Gate Voltage

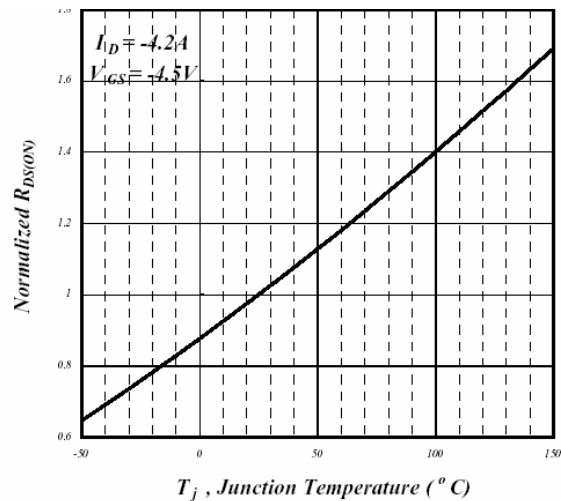

Fig 4. Normalized On-Resistance v.s. Junction Temperature

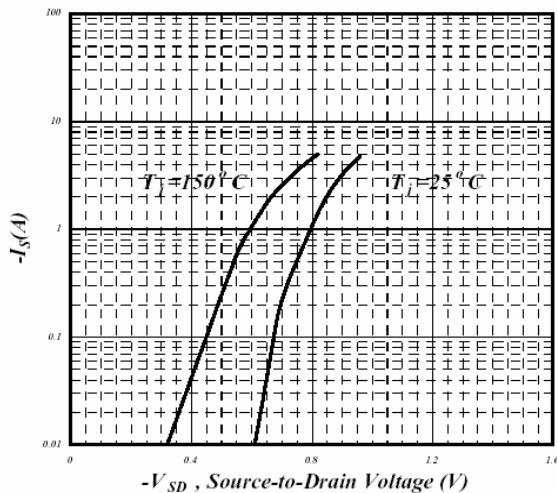

Fig 5. Forward Characteristic of Reverse Diode

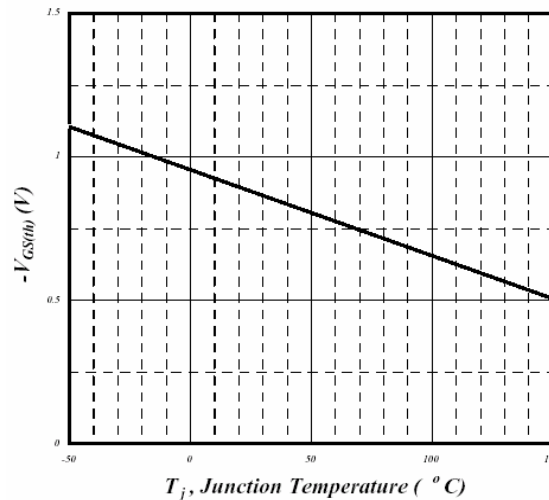

Fig 6. Gate Threshold Voltage v.s. Junction Temperature

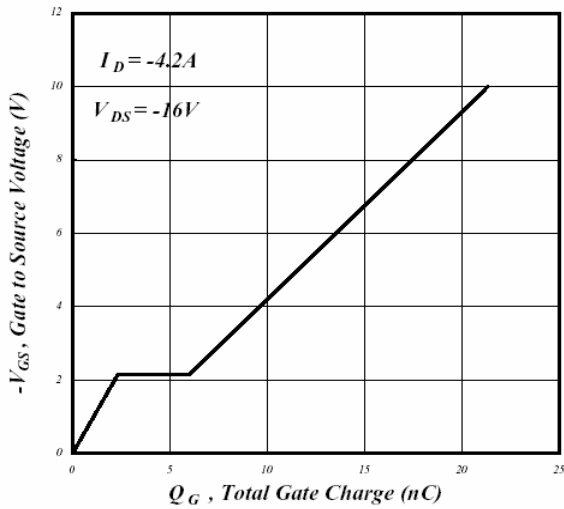

Fig 7. Gate Charge Characteristics

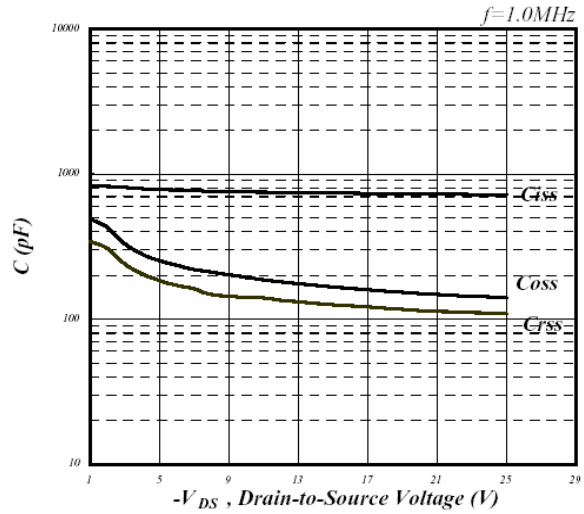

Fig 8. Typical Capacitance Characteristics

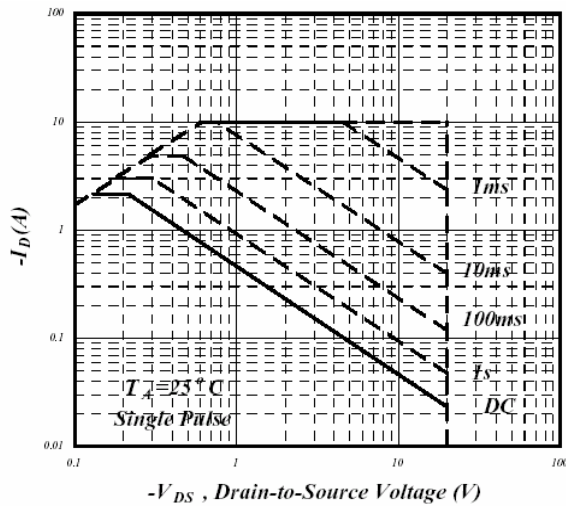

Fig 9. Maximum Safe Operating Area

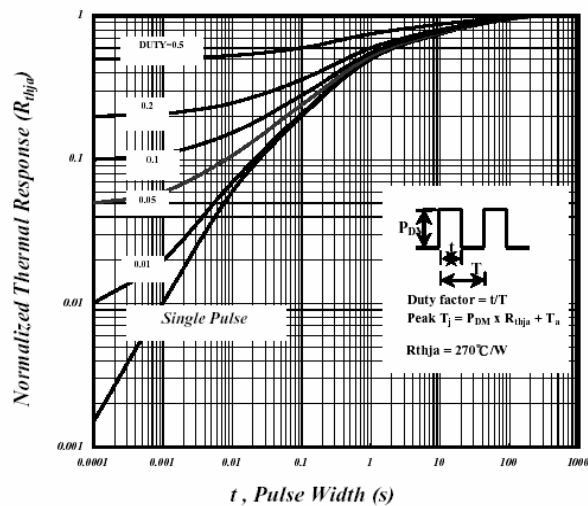

Fig 10. Effective Transient Thermal Impedance

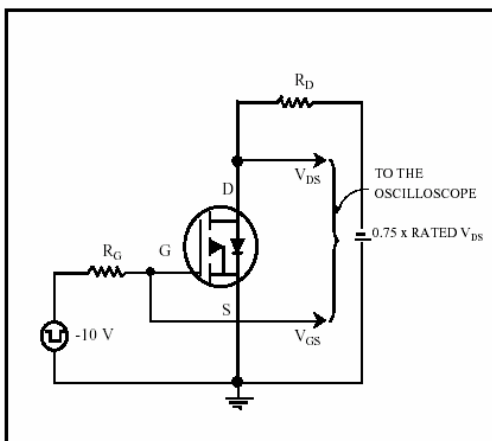

Fig 11. Switching Time Circuit

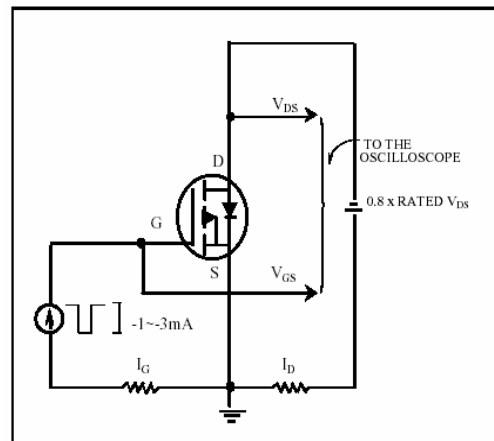

Fig 12. Gate Charge Circuit