

DATA SHEET

SMP1345 Series: Very Low Capacitance, Plastic Packaged Silicon PIN Diodes

Applications

- High isolation LNBs, WLANs, and wireless switches

Features

- Very low insertion loss: 0.4 dB
- Capacitance: 0.15 pF
- Packages rated MSL1, 260 °C per JEDEC J-STD-020



Skyworks Green™ products are compliant with all applicable legislation and are halogen-free. For additional information, refer to *Skyworks Definition of Green™*, document number SQ04-0074.





Description

The SMP1345 series of plastic packaged, surface mountable PIN diodes is designed for high volume Low-Noise Block (LNB), Wireless Local Area Network (WLAN), and switch applications from 10 MHz to 6 GHz. The short carrier lifetime of 100 ns (typical), combined with their thin I-region width of 10 μm (nominal) results in a group of fast speed RF switching PIN diodes.

The RF performance of the SMP1345 series is assured by virtue of their very low capacitance (0.15 pF) and low resistance (1.5 Ω at 10 mA).

Table 1 describes the various packages and marking of the SMP1345 series.

Table 1. SMP1345 Series Packaging and Marking

		
Common Cathode	Single	Single
SOT-23	SC-79 Green™	SOD-882 Green™
SMP1345-004LF Green™ Marking: RU3	SMP1345-079LF Marking: Cathode and CF	SMP1345-040LF Marking: U
$L_s = 1.5 \text{ nH}$	$L_s = 0.7 \text{ nH}$	$L_s = 0.45 \text{ nH}$

Electrical and Mechanical Specifications

The absolute maximum ratings of the SMP1345 series are provided in Table 2. Electrical specifications are provided in Table 3.

Typical performance characteristics of the SMP1345 series are illustrated in Figures 1 through 6.

Table 2. SMP1345 Series Absolute Maximum Ratings¹

Parameter	Symbol	Minimum	Maximum	Units
Reverse voltage	V_R		50	V
Power dissipation @ 25 °C lead temperature	P_D		250	mW
Storage temperature	T_{STG}	-65	+150	°C
Operating temperature	T_A	-65	+150	°C
Electrostatic discharge: Human Body Model (HBM), Class 1B	ESD		1000	V

¹ Exposure to maximum rating conditions for extended periods may reduce device reliability. There is no damage to device with only one parameter set at the limit and all other parameters set at or below their nominal value. Exceeding any of the limits listed here may result in permanent damage to the device.

ESD HANDLING: *Although this device is designed to be as robust as possible, electrostatic discharge (ESD) can damage this device. This device must be protected at all times from ESD when handling or transporting. Static charges may easily produce potentials of several kilovolts on the human body or equipment, which can discharge without detection. Industry-standard ESD handling precautions should be used at all times.*

Table 3. SMP1345 Series Electrical Specifications¹
($T_A = +25\text{ °C}$, Unless Otherwise Noted)

Parameter	Symbol	Test Condition	Min	Typ	Max	Units
Reverse current	I_R	$V_R = 50\text{ V}$			10	μA
Capacitance	C_T	F = 1 MHz: V = 1 V V = 5 V		0.19		pF
				0.18	0.20	pF
Resistance	R_S	F = 100 MHz: I = 1 mA I = 10 mA		3.5		Ω
				1.5	2.0	Ω
Forward voltage	V_F	$I_F = 10\text{ mA}$		0.89		V
Carrier lifetime	τ_I	$I_F = 10\text{ mA}$		100		ns
I region width				10		μm

¹ Performance is guaranteed only under the conditions listed in this table.

Typical Performance Characteristics

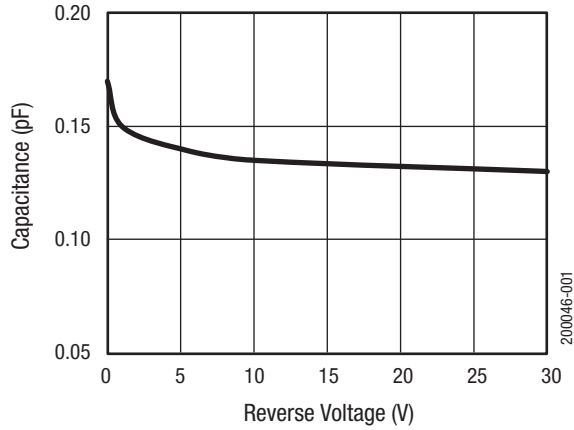

Figure 1. Total Capacitance vs Reverse Voltage

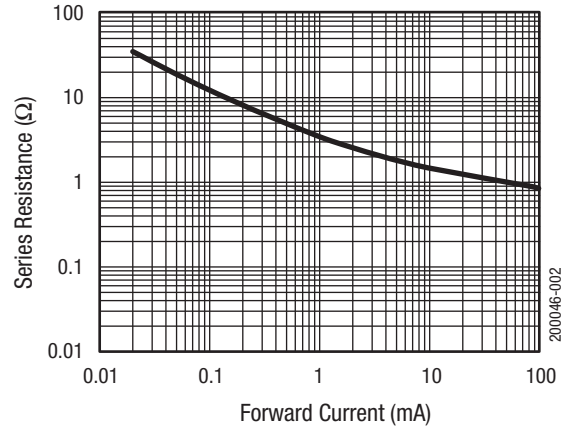

Figure 2. Series Resistance vs Current @ 100 MHz

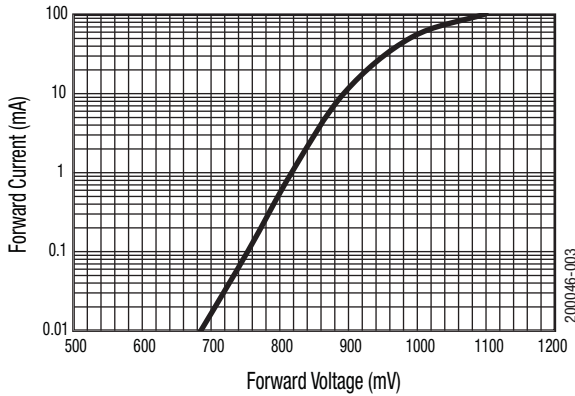
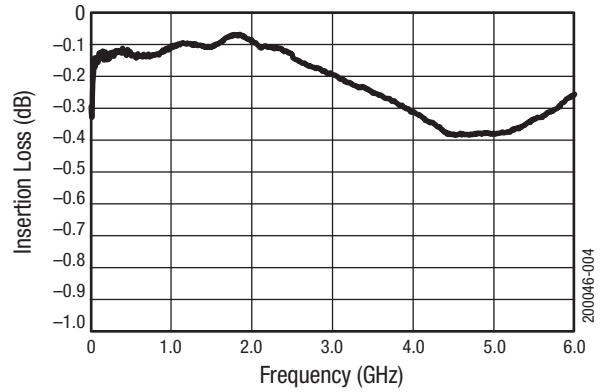
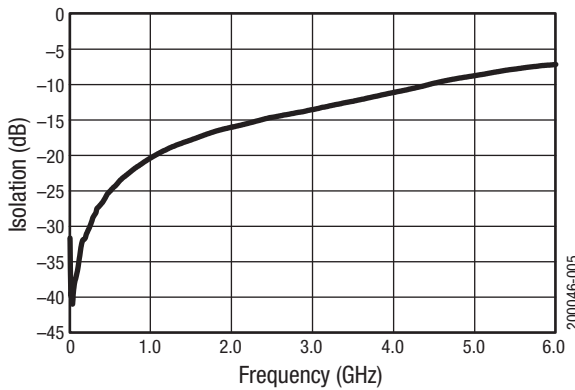

Figure 3. Forward Current vs Forward Voltage



**Figure 4. Insertion Loss vs Frequency
($I_F = 10$ mA)**



**Figure 5. Isolation vs Frequency
($V_R = 0$ V)**

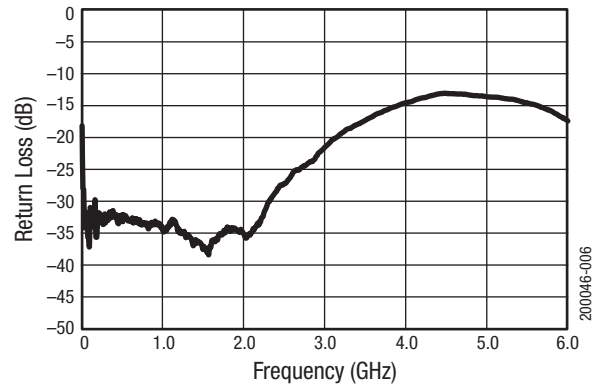

**Figure 6. Return Loss vs Frequency
($I_F = 10$ mA)**

Package Dimensions

Package dimensions are shown in Figures 7 to 11 (odd numbers), and tape and reel dimensions are provided in Figures 8 to 12 (even numbers).

Package and Handling Information

Instructions on the shipping container label regarding exposure to moisture after the container seal is broken must be followed. Otherwise, problems related to moisture absorption may occur when the part is subjected to high temperature during solder assembly.

The SMP1345 series is rated to Moisture Sensitivity Level 1 (MSL1) at 260 °C. It can be used for lead or lead-free soldering. For additional information, refer to the Skyworks Application Note, *Solder Reflow Information*, document number 200164.

Care must be taken when attaching this product, whether it is done manually or in a production solder reflow environment. Production quantities of this product are shipped in a standard tape and reel format.

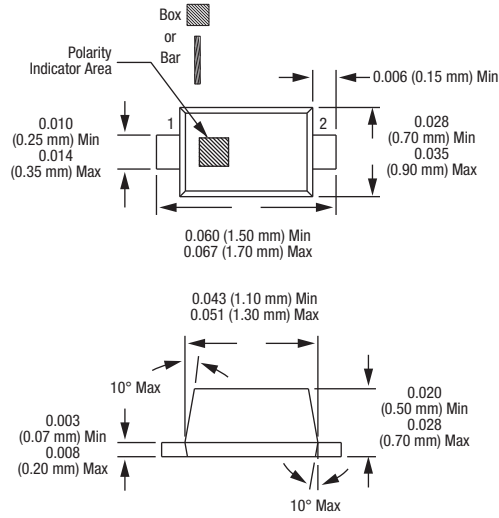

Dimensions are in inches (millimeters shown in parentheses) 200046-007

Figure 7. SC-79 Package Dimension Drawing

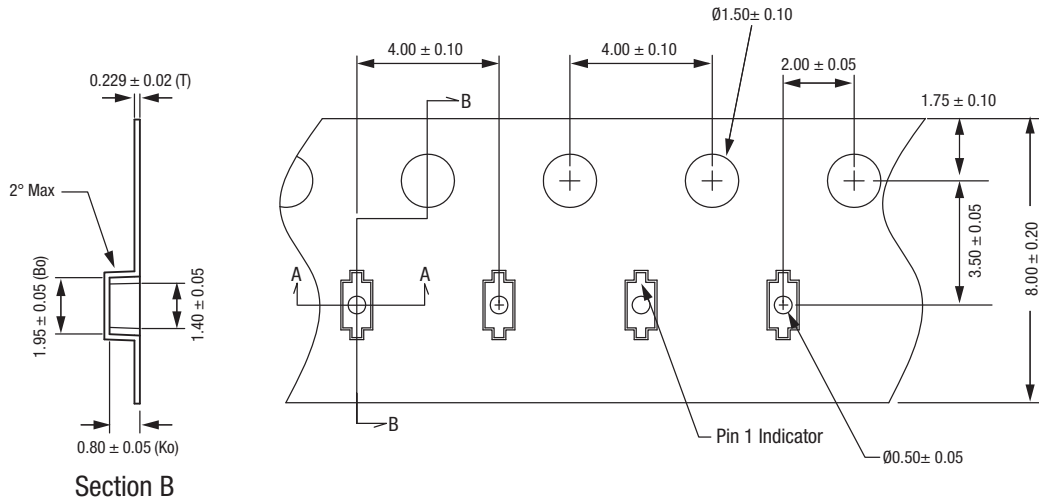

Notes:

1. Carrier tape: black conductive polycarbonate or polystyrene.
2. Cover tape material: transparent conductive PSA.
3. Cover tape size: 5.4 mm width.
4. ESD-surface resistivity is $\leq 1 \times 10^8$ Ohms/square per EIA, JEDEC TNR Specification.
5. All measurements are in millimeters.

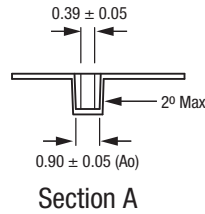

200046-008

Figure 8. SC-79 Tape and Reel Dimensions

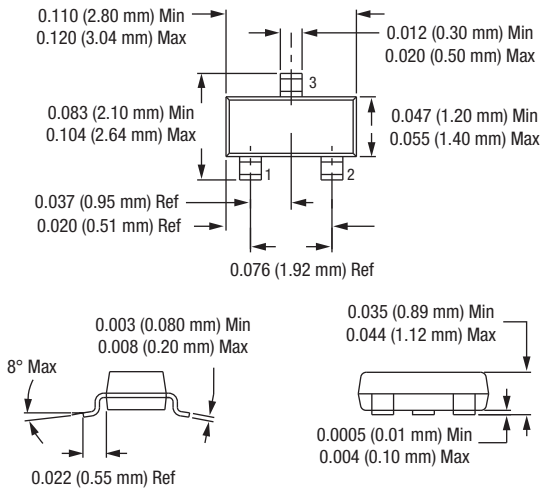

Dimensions are in inches (millimeters shown in parentheses)

200046-009

Figure 9. SOT-23 Package Dimension Drawing

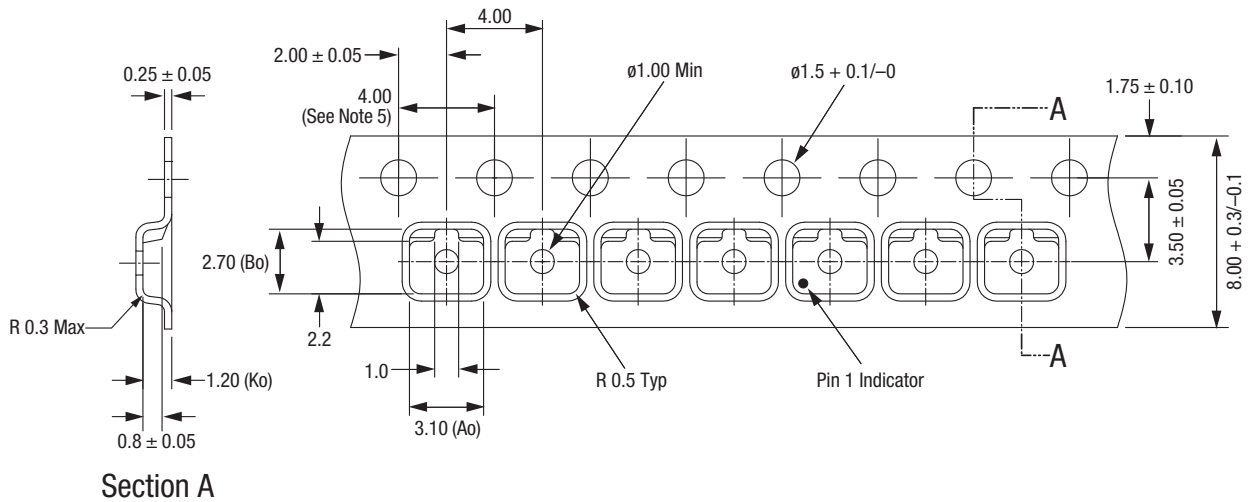

Section A

Notes:

1. Carrier tape: black conductive polycarbonate.
2. Cover tape material: transparent conductive PSA.
3. Cover tape size: 5.40 mm width.
4. Tolerance ± 0.10 mm.
5. Ten sprocket hole pitch cumulative tolerance: ± 0.2 mm.
6. All measurements are in millimeters.
7. Alternative carrier tape dimensions are:
 $Ao = 3.3$
 $Bo = 2.9$
 $Ko = 1.22$

200046-010

Figure 10. SOT-23 Tape and Reel Dimensions

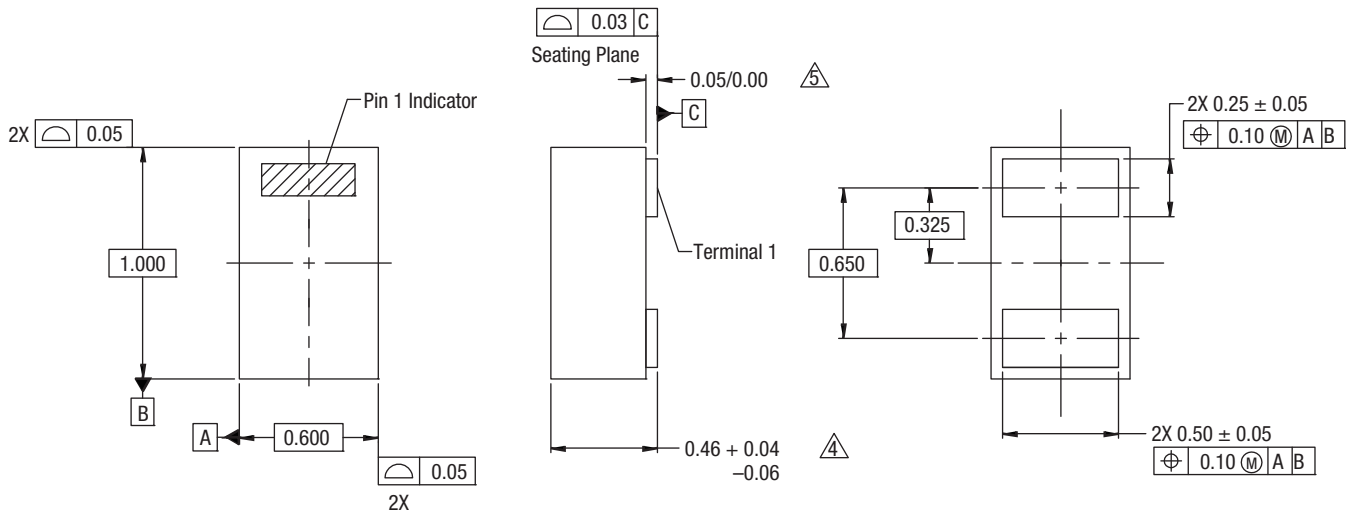

Notes:

1. All measurements are in millimeters.
2. Dimensions and tolerances according to ASME Y14.5M-1994.
3. These packages are used principally for discrete devices.
4. This dimension includes stand-off height and package body thickness, but does not include attached features, e.g., external heatsink or chip capacitors. An integral heatslug is not considered an attached feature.
5. This dimension is primarily terminal plating, but does not include small metal protrusion.

200046-011

Figure 11. SOD-882 Package Dimension Drawing

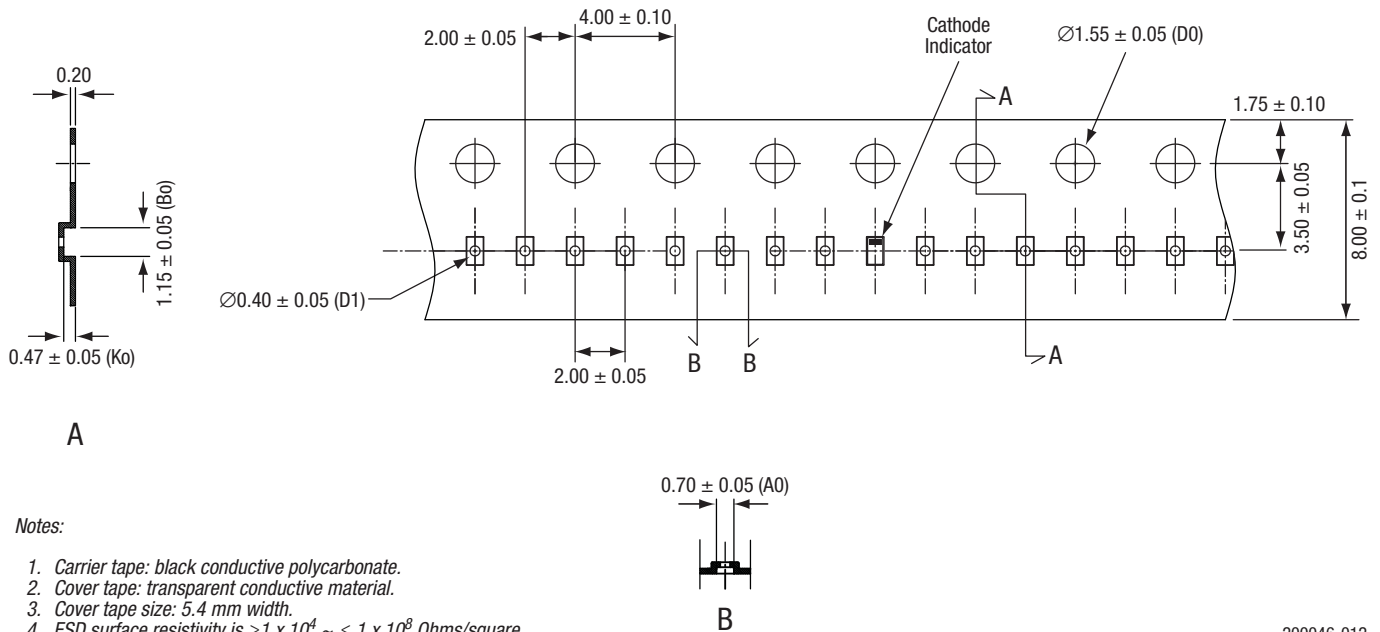

Notes:

1. Carrier tape: black conductive polycarbonate.
2. Cover tape: transparent conductive material.
3. Cover tape size: 5.4 mm width.
4. ESD surface resistivity is $\geq 1 \times 10^4 \sim \leq 1 \times 10^8$ Ohms/square.
5. All dimensions are in millimeters.

200046-012

Figure 12. SOD-882 Tape and Reel Drawing

Copyright © 2002-2007, 2009- 2012, 2014-2016, 2018 Skyworks Solutions, Inc. All Rights Reserved.

Information in this document is provided in connection with Skyworks Solutions, Inc. ("Skyworks") products or services. These materials, including the information contained herein, are provided by Skyworks as a service to its customers and may be used for informational purposes only by the customer. Skyworks assumes no responsibility for errors or omissions in these materials or the information contained herein. Skyworks may change its documentation, products, services, specifications or product descriptions at any time, without notice. Skyworks makes no commitment to update the materials or information and shall have no responsibility whatsoever for conflicts, incompatibilities, or other difficulties arising from any future changes.

No license, whether express, implied, by estoppel or otherwise, is granted to any intellectual property rights by this document. Skyworks assumes no liability for any materials, products or information provided hereunder, including the sale, distribution, reproduction or use of Skyworks products, information or materials, except as may be provided in Skyworks Terms and Conditions of Sale.

THE MATERIALS, PRODUCTS AND INFORMATION ARE PROVIDED "AS IS" WITHOUT WARRANTY OF ANY KIND, WHETHER EXPRESS, IMPLIED, STATUTORY, OR OTHERWISE, INCLUDING FITNESS FOR A PARTICULAR PURPOSE OR USE, MERCHANTABILITY, PERFORMANCE, QUALITY OR NON-INFRINGEMENT OF ANY INTELLECTUAL PROPERTY RIGHT; ALL SUCH WARRANTIES ARE HEREBY EXPRESSLY DISCLAIMED. SKYWORKS DOES NOT WARRANT THE ACCURACY OR COMPLETENESS OF THE INFORMATION, TEXT, GRAPHICS OR OTHER ITEMS CONTAINED WITHIN THESE MATERIALS. SKYWORKS SHALL NOT BE LIABLE FOR ANY DAMAGES, INCLUDING BUT NOT LIMITED TO ANY SPECIAL, INDIRECT, INCIDENTAL, STATUTORY, OR CONSEQUENTIAL DAMAGES, INCLUDING WITHOUT LIMITATION, LOST REVENUES OR LOST PROFITS THAT MAY RESULT FROM THE USE OF THE MATERIALS OR INFORMATION, WHETHER OR NOT THE RECIPIENT OF MATERIALS HAS BEEN ADVISED OF THE POSSIBILITY OF SUCH DAMAGE.

Skyworks products are not intended for use in medical, lifesaving or life-sustaining applications, or other equipment in which the failure of the Skyworks products could lead to personal injury, death, physical or environmental damage. Skyworks customers using or selling Skyworks products for use in such applications do so at their own risk and agree to fully indemnify Skyworks for any damages resulting from such improper use or sale.

Customers are responsible for their products and applications using Skyworks products, which may deviate from published specifications as a result of design defects, errors, or operation of products outside of published parameters or design specifications. Customers should include design and operating safeguards to minimize these and other risks. Skyworks assumes no liability for applications assistance, customer product design, or damage to any equipment resulting from the use of Skyworks products outside of stated published specifications or parameters.

Skyworks and the Skyworks symbol are trademarks or registered trademarks of Skyworks Solutions, Inc. or its subsidiaries in the United States and other countries. Third-party brands and names are for identification purposes only, and are the property of their respective owners. Additional information, including relevant terms and conditions, posted at www.skyworksinc.com, are incorporated by reference.