

## 2N5460, 2N5461, 2N5462 P-Channel JFET

### Features

- InterFET [P0032F Geometry](#)
- Typical Noise: 2.7 nV/√Hz
- Low Ciss: 3.2pF Typical
- RoHS Compliant
- SMT, TH, and Bare Die Package options.

### Applications

- Audio Amplifiers
- General Purpose Amplifiers

### Description

The 40V InterFET 2N5460, 2N5461, and 2N5462 JFET's are targeted for sensitive amplifier stages for mid-frequencies designs. Input capacitance is typically 3.2pF. The 2N5462 is target for higher gain applications with a typical  $G_{fs}$  of 3.5mS.

SOT23 Top View

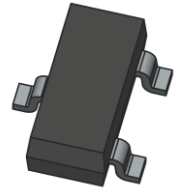
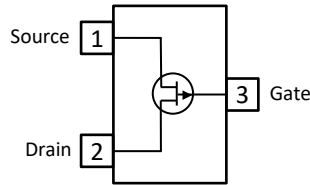

TO-92 Bottom View

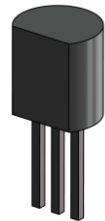
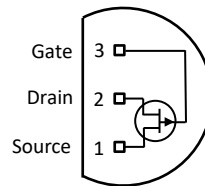

### Product Summary

Parameters	2N5460 Min	2N5461 Min	2N5462 Min	Unit
$BV_{GSS}$ Gate to Source Breakdown Voltage	40	40	40	V
$I_{DSS}$ Drain to Source Saturation Current	-1	-2	-4	mA
$V_{GS(off)}$ Gate to Source Cutoff Voltage	0.75	1	1.8	V
$G_{FS}$ Forward Transconductance	1000	1500	2000	$\mu S$

### Ordering Information Custom Part and Binning Options Available

Part Number	Description	Case	Packaging
2N5460; 2N5461; 2N5462	Through-Hole	TO-92	Bulk
SMP5460; SMP5461; SMP5462	Surface Mount	SOT23	Bulk
SMP5460TR; SMP5461TR; SMP5462TR	7" Tape and Reel: Max 3,000 Pieces 13" Tape and Reel: Max 9,000 Pieces	SOT23	Minimum 1,000 Pieces Tape and Reel
2N5460COT; 2N5461COT; 2N5462COT	Chip Orientated Tray (COT Waffle Pack)	COT	400/Waffle Pack
2N5460CFT; 2N5461CFT; 2N5462CFT	Chip Face-up Tray (CFT Waffle Pack)	CFT	400/Waffle Pack



**Disclaimer:** It is the Buyers responsibility for designing, validating and testing the end application under all field use cases and extreme use conditions. Guaranteeing the application meets required standards, regulatory compliance, and all safety and security requirements is the responsibility of the Buyer. These resources are subject to change without notice.

## Electrical Characteristics

### Maximum Ratings (@ $T_A = 25^\circ\text{C}$ , Unless otherwise specified)

Parameters	Value	Unit
$V_{RGS}$ Reverse Gate Source and Gate Drain Voltage	40	V
$I_{FG}$ Continuous Forward Gate Current	50	mA
$P_D$ Continuous Device Power Dissipation	300	mW
$P$ Power Derating	1.7	mW/ $^\circ\text{C}$
$T_J$ Operating Junction Temperature	-55 to 125	$^\circ\text{C}$
$T_{STG}$ Storage Temperature	-65 to 200	$^\circ\text{C}$

### Static Characteristics (@ $T_A = 25^\circ\text{C}$ , Unless otherwise specified)

Parameters	Conditions	2N5460		2N5461		2N5462		Unit
		Min	Max	Min	Max	Min	Max	
$V_{(BR)GSS}$ Gate to Source Breakdown Voltage	$V_{DS} = 0V, I_G = 10\mu\text{A}$	40		40		40		V
$I_{GSS}$ Gate to Source Reverse Current	$V_{GS} = 20V, V_{DS} = 0V, T_A = 25^\circ\text{C}$		5		5		5	nA
	$V_{GS} = 20V, V_{DS} = 0V, T_A = 100^\circ\text{C}$		1		1		1	$\mu\text{A}$
$V_{GS(OFF)}$ Gate to Source Cutoff Voltage	$V_{DS} = -15V, I_D = -1\mu\text{A}$	0.75	6	1	7.5	1.8	9	V
$V_{GS}$ Gate to Source Voltage	$V_{DS} = -15V, I_D = -100\mu\text{A}$	0.8	4.5					V
	$V_{DS} = -15V, I_D = -200\mu\text{A}$			0.8	4.5			
	$V_{DS} = -15V, I_D = -400\mu\text{A}$					1.5	6	
$I_{DSS}$ Drain to Source Saturation Current	$V_{DS} = -15V, V_{GS} = 0V$ (Pulsed)	-1	-5	-2	-9	-4	-16	mA

### Dynamic Characteristics (@ $T_A = 25^\circ\text{C}$ , Unless otherwise specified)

Parameters	Conditions	2N5460		2N5461		2N5462		Unit
		Min	Max	Min	Max	Min	Max	
$G_{FS}$ Forward Transconductance	$V_{DS} = -15V, V_{GS} = 0V, f = 1\text{kHz}$	1000	4000	1500	5000	2000	6000	$\mu\text{S}$
$G_{OS}$ Output Conductance	$V_{DS} = -15V, V_{GS} = 0V, f = 1\text{kHz}$		75		75		75	$\mu\text{S}$
$C_{iss}$ Input Capacitance	$V_{DS} = -15V, V_{GS} = 0V, f = 1\text{MHz}$		7		7		7	pF
$C_{rss}$ Reverse Transfer Capacitance	$V_{DS} = -15V, V_{GS} = 0V, f = 1\text{MHz}$		2		2		2	pF
$e_n$ Equivalent Circuit Input Noise Voltage	$V_{DS} = -15V, V_{GS} = 0V, R_G = 1\text{M}\Omega,$ $BW = 1\text{Hz}, f = 100\text{Hz}$		115		115		115	nV/ $\sqrt{\text{Hz}}$
NF Noise Figure	$V_{DS} = -15V, V_{GS} = 0V, f = 1\text{kHz}$		2.5		2.5		2.5	dB

## SOT23 (TO-236AB) Mechanical and Layout Data

### Package Outline Data



1. All linear dimensions are in millimeters.
2. Package weight approximately 0.12 grams
3. Molded plastic case UL 94V-0 rated
4. For Tape and Reel specifications refer to InterFET CTC-021 Tape and Reel Specification, Document number: IF39002
5. Bulk product is shipped in standard ESD shipping material
6. Refer to JEDEC standards for additional information.

### Suggested Pad Layout

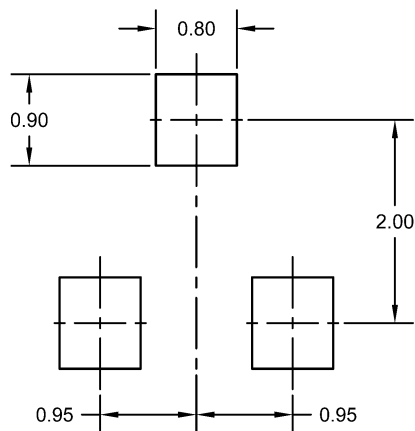

1. All linear dimensions are in millimeters.
2. The suggested land pattern dimensions have been provided for reference only. A more robust pattern may be desired for wave soldering.

## TO-92 Mechanical and Layout Data

### Package Outline Data

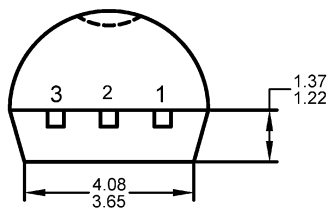
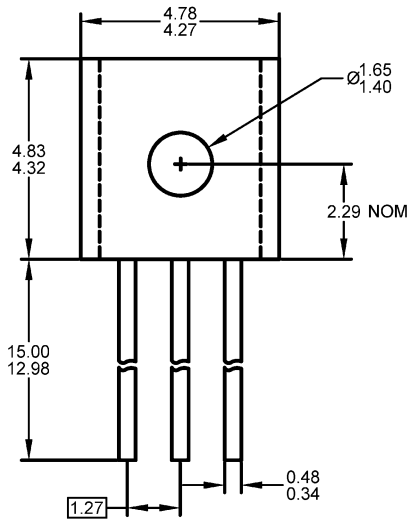

1. All linear dimensions are in millimeters.
2. Package weight approximately 0.19 grams
3. Molded plastic case UL 94V-0 rated
4. Bulk product is shipped in standard ESD shipping material
5. Refer to JEDEC standards for additional information.

### Suggested Through-Hole Layout

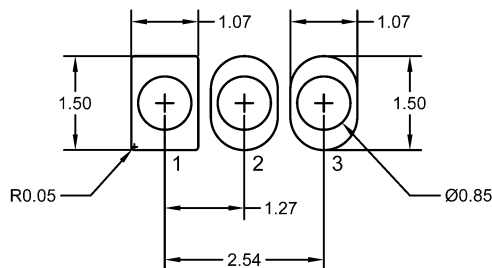

1. All linear dimensions are in millimeters.
2. The suggested land pattern dimensions have been provided as a straight lead reference only. A more robust pattern may be desired for wave soldering and/or bent lead configurations.