

# SMT-300

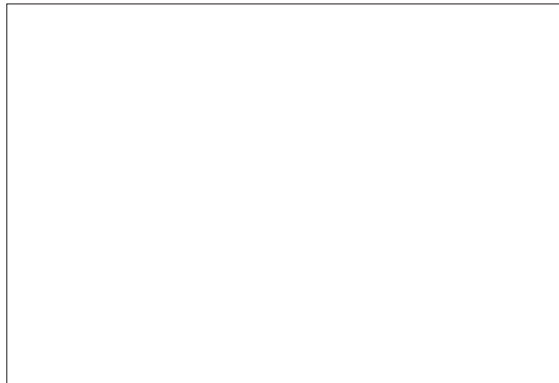

## Phase Control Thyristor

www.DataSheet4U.com



Type	$V_{RRM}$	$I_{TAVM}$ ( $T_c, ^\circ C$ )	$I_{TRMS}$	$I_{TSM}$	$(di/dt)_{cr}$	$(dv/dt)_{cr}$	$V_{TM}$	$I_{TM}$	$V_{GT}$	$I_{GT}$	$V_{TO}$	$r_T$	$T_{VJM}$	$R_{thJC}$
	V	A	A	kA	A/ $\mu s$	V/ $\mu s$	V	A	V	mA	V	m $\Omega$	$^\circ C$	K/W
SMT-300	300-2000	300 (85)	430	7.2	150	800	2.0	900	2.5	200	1.0	0.7	125	0.08

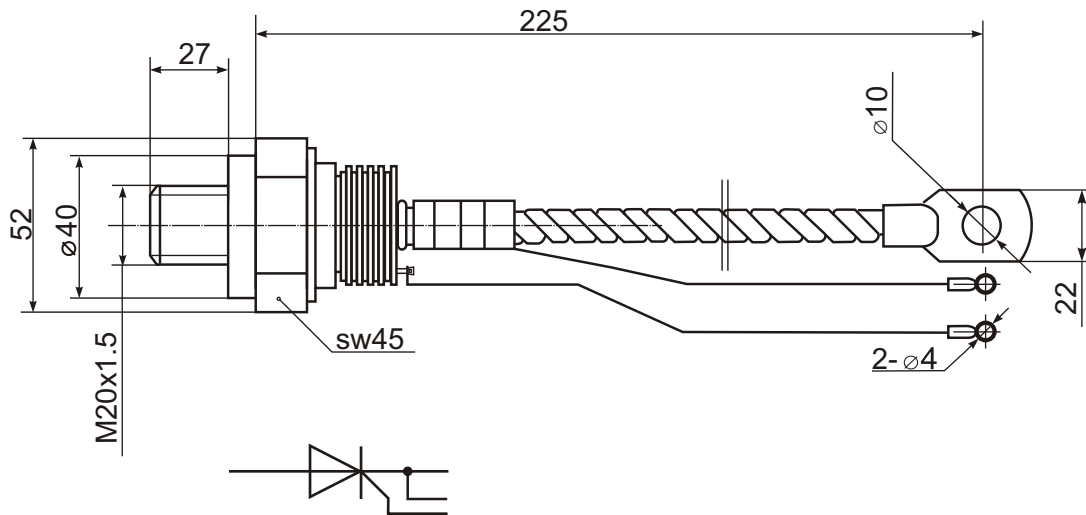

### Features:

- Hermetic metal case with ceramic insulator
- Capacity of supporting high surge current
- International standard case

### Typical Applications:

- Controlled DC power supplies
- DC motor controls
- AC switch and thermal control