

REV.	ECN. NO.	NAME	DATE

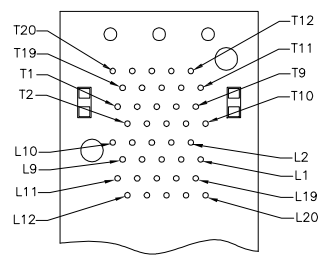

CONNECTOR PIN-OUT
COMPONENT SIDE OF BOARD

NOTES:
 MATERIAL:
 CAGE: NICKEL SILVER
 CONNECTOR:
 PLASTIC HOUSING: HIGH TEMPERATURE LCP, UL94 V-0.
 LIGHT PIPE: POLYCARBONATE; COLOR: CLEAR
 SPRING: STAINLESS STEEL
 CONTACTS: PHOSPHOR BRONZE
 CONTACT PLATING: 15u" MIN. GOLD ON MATING AREA,
 150u" MATTE TIN ON SOLDER TAILS
 PACKAGING: TRAY PACKAGING.
 TEMPERATURE RANGE: -40°C TO +85°C

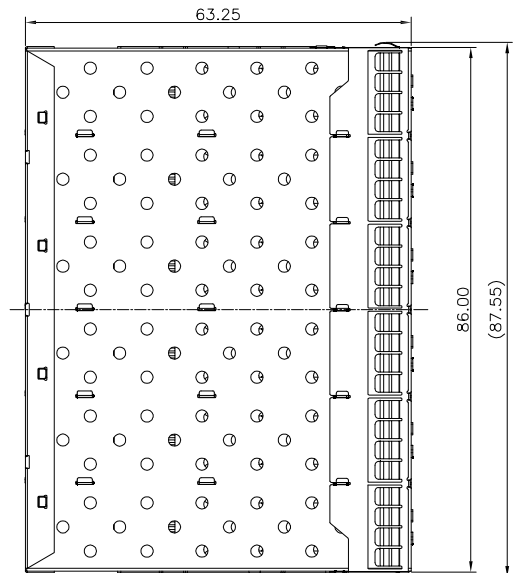
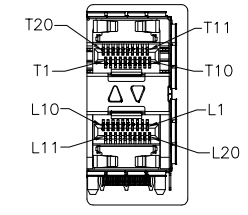
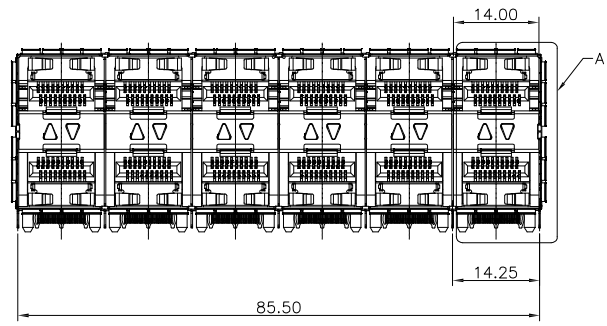
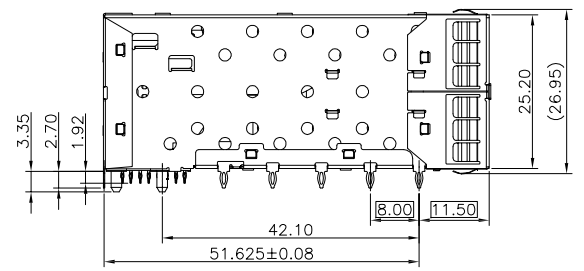

DETAIL A
1:1

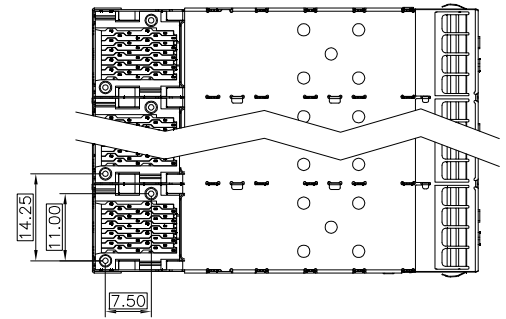

RoHS Compliant

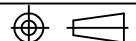
TOLERANCE UNSPECIFIED		 a vital connector company		FOR YOUR VITAL CONNECTION	
.0	± 0.38				
.00	± 0.25	TITLE: SFP+2*6CAGE+ CONN			
.000	± 0.10				
ANGLE	± 3.00°	DRAWN BY: BECKER		PART NO: SN261	
MANUFACTURING COPY		CHECKED BY: VTA		REV: A	
		APPROVED BY: QPF		SIZE: A4	
				UNIT: mm	
				SHEET: 10F3	
				FCN: A4	
				 http://www.vitalconn.com	

REV.	ECN. NO.	NAME	DATE

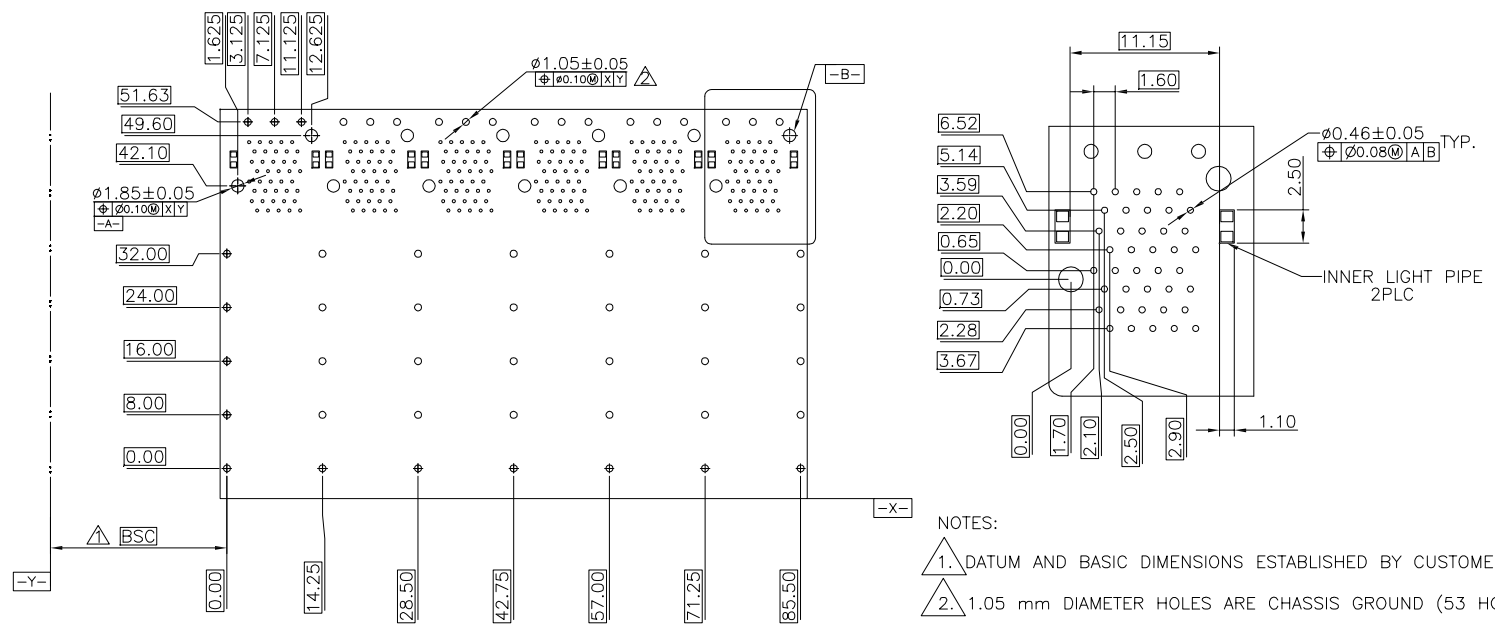

- NOTES:
1. DATUM AND BASIC DIMENSIONS ESTABLISHED BY CUSTOMER.
 2. 1.05 mm DIAMETER HOLES ARE CHASSIS GROUND (53 HOLES).

ECOMMENDED PCB CONFIGURATION

RoHS Compliant

TOLERANCE UNSPECIFIED		 VITALCONN a vital connector company		FOR YOUR VITAL CONNECTION	
.0	± 0.38			TITLE: SFP+2*6CAGE+ CONN	
.00	± 0.25	DRAWN BY:	BECKER	PART NO:	SN261
.000	± 0.10	CHECKED BY:	VTA	SIZE: A4	UNIT: mm
ANGLE	± 3.00°	APPROVED BY:	QPF	PROJECTION	
MANUFACTURING COPY				SHEET: 20F3	FCN: A4
				http://www.vitalconn.com	

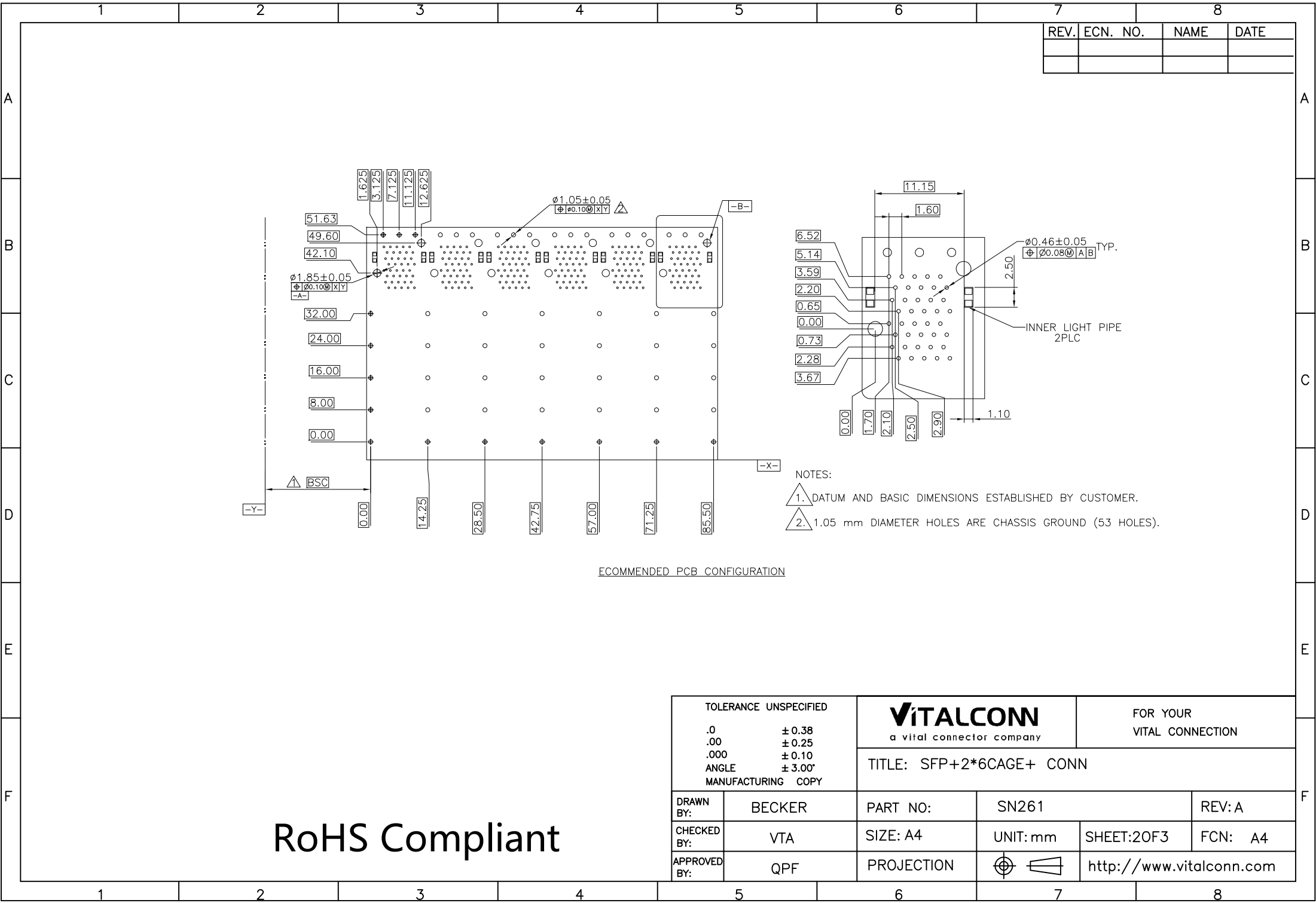

REV.	ECN. NO.	NAME	DATE

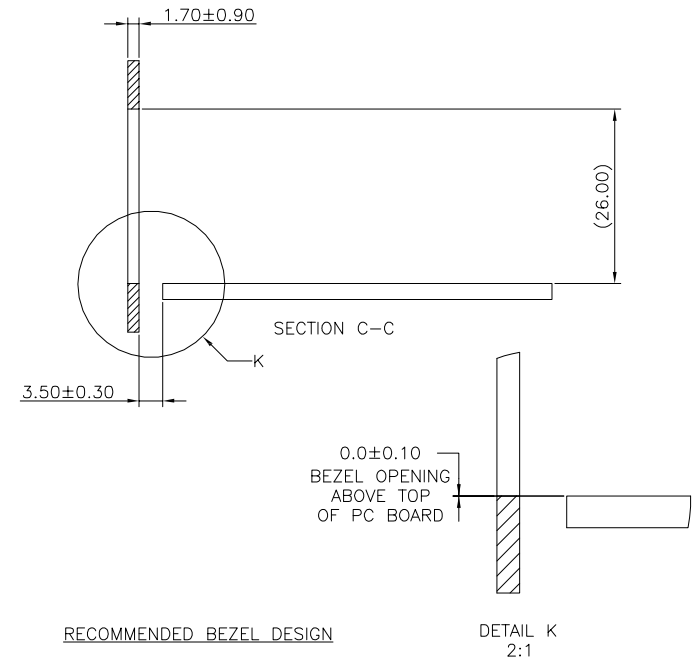
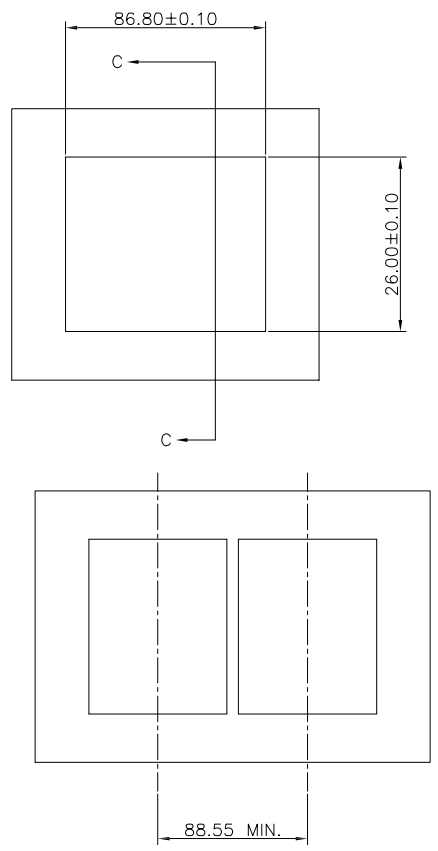

RoHS Compliant

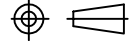
TOLERANCE UNSPECIFIED		 a vital connector company		FOR YOUR VITAL CONNECTION	
.0	± 0.38			TITLE: SFP+2*6CAGE+ CONN	
.00	± 0.25	DRAWN BY:	BECKER	PART NO:	SN261
.000	± 0.10	CHECKED BY:	VTA	SIZE: A4	UNIT: mm
ANGLE	± 3.00°	APPROVED BY:	QPF	PROJECTION	
MANUFACTURING COPY		http://www.vitalconn.com		SHEET:30F3	FCN: A4

