

SN54ALS86, SN54AS86A, SN74ALS86, SN74AS86A QUADRUPLE 2-INPUT EXCLUSIVE-OR GATES

SDAS006B – APRIL 1982 – REVISED DECEMBER 1994

- Package Options Include Plastic Small-Outline (D) Packages, Ceramic Chip Carriers (FK), and Standard Plastic (N) and Ceramic (J) 300-mil DIPs

description

These devices contain four independent 2-input exclusive-OR gates. They perform the Boolean functions $Y = A \oplus B$ or $Y = \overline{AB} + A\overline{B}$ in positive logic.

A common application is as a true/complement element. If one of the inputs is low, the other input is reproduced in true form at the output. If one of the inputs is high, the signal on the other input is reproduced inverted at the output.

The SN54ALS86 and SN54AS86A are characterized for operation over the full military temperature range of -55°C to 125°C . The SN74ALS86 and SN74AS86A are characterized for operation from 0°C to 70°C .

FUNCTION TABLE
(each gate)

INPUTS		OUTPUT
A	B	Y
L	L	L
L	H	H
H	L	H
H	H	L

SN54ALS86, SN54AS86A . . . J PACKAGE
SN74ALS86, SN74AS86A . . . D OR N PACKAGE
(TOP VIEW)

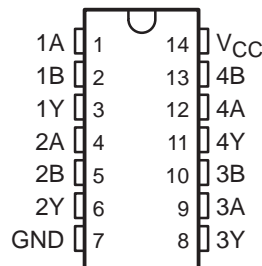

SN54ALS86, SN54AS86A . . . FK PACKAGE
(TOP VIEW)

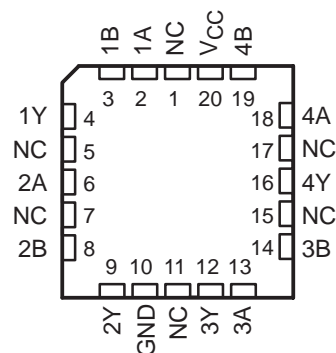

NC – No internal connection

logic symbol†

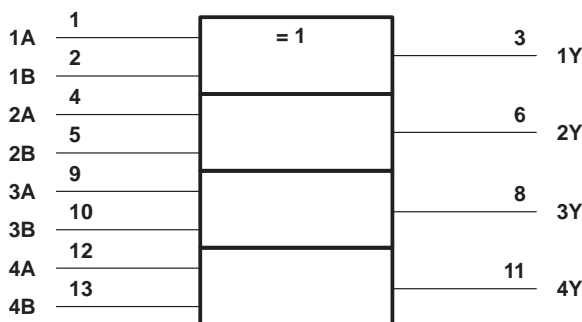

† This symbol is in accordance with ANSI/IEEE Std 91-1984 and IEC Publication 617-12. Pin numbers shown are for the D, J, and N packages.

SN54ALS86, SN54AS86A, SN74ALS86, SN74AS86A QUADRUPLE 2-INPUT EXCLUSIVE-OR GATES

SDAS006B – APRIL 1982 – REVISED DECEMBER 1994

exclusive-OR logic

An exclusive-OR gate has many applications, some of which can be represented better by alternative logic symbols.

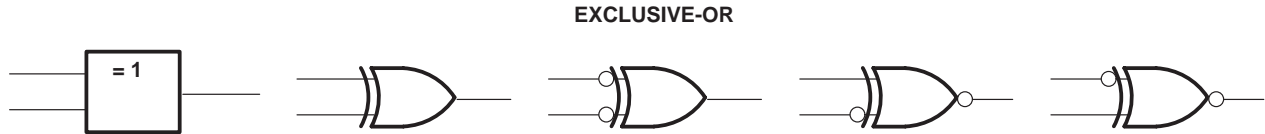

These are five equivalent exclusive-OR symbols valid for an 'ALS86 or 'AS86A gate in positive logic. Negation may be shown at any two ports.

LOGIC-IDENTITY ELEMENT



The output is active (low) if all inputs are at the same logic level (i.e., $A = B$).

EVEN-PARITY ELEMENT

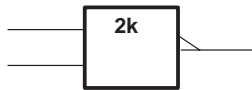

The output is active (low) if an even number of inputs (i.e., 0 or 2) are active.

ODD-PARITY ELEMENT

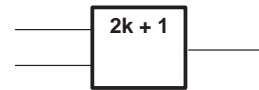

The output is active (high) if an odd number of inputs (i.e., only 1 of the 2) are active.

SN54ALS86, SN54AS86A, SN74ALS86, SN74AS86A QUADRUPLE 2-INPUT EXCLUSIVE-OR GATES

SDAS006B – APRIL 1982 – REVISED DECEMBER 1994

absolute maximum ratings over operating free-air temperature range (unless otherwise noted)†

Supply voltage, V_{CC}	7 V
Input voltage, V_I	7 V
Operating free-air temperature range, T_A : SN54ALS86	–55°C to 125°C
SN74ALS86	0°C to 70°C
Storage temperature range	–65°C to 150°C

† Stresses beyond those listed under “absolute maximum ratings” may cause permanent damage to the device. These are stress ratings only, and functional operation of the device at these or any other conditions beyond those indicated under “recommended operating conditions” is not implied. Exposure to absolute-maximum-rated conditions for extended periods may affect device reliability.

recommended operating conditions

		SN54ALS86			SN74ALS86			UNIT
		MIN	NOM	MAX	MIN	NOM	MAX	
V_{CC}	Supply voltage	4.5	5	5.5	4.5	5	5.5	V
V_{IH}	High-level input voltage	2			2			V
V_{IL}	Low-level input voltage			0.7			0.8	V
I_{OH}	High-level output current			–0.4			–0.4	mA
I_{OL}	Low-level output current			4			8	mA
T_A	Operating free-air temperature	–55		125	0		70	°C

electrical characteristics over recommended operating free-air temperature range (unless otherwise noted)

PARAMETER	TEST CONDITIONS	SN54ALS86			SN74ALS86			UNIT
		MIN	TYP‡	MAX	MIN	TYP‡	MAX	
V_{IK}	$V_{CC} = 4.5\text{ V}$, $I_I = -18\text{ mA}$			–1.5			–1.5	V
V_{OH}	$V_{CC} = 4.5\text{ V to } 5.5\text{ V}$, $I_{OH} = -0.4\text{ mA}$	$V_{CC} - 2$			$V_{CC} - 2$			V
V_{OL}	$V_{CC} = 4.5\text{ V}$	$I_{OL} = 4\text{ mA}$		0.25	0.4	$I_{OL} = 4\text{ mA}$		V
		$I_{OL} = 8\text{ mA}$				0.35	0.5	
I_I	$V_{CC} = 5.5\text{ V}$, $V_I = 7\text{ V}$			0.1			0.1	mA
I_{IH}	$V_{CC} = 5.5\text{ V}$, $V_I = 2.7\text{ V}$			20			20	μA
I_{IL}	$V_{CC} = 5.5\text{ V}$, $V_I = 0.4\text{ V}$			–0.1			–0.1	mA
$I_{OS}§$	$V_{CC} = 5.5\text{ V}$, $V_O = 2.25\text{ V}$	–20		–112	–30		–112	mA
I_{CC}	$V_{CC} = 5.5\text{ V}$, All inputs at 4.5 V		3.9	5.9		3.9	5.9	mA

‡ All typical values are at $V_{CC} = 5\text{ V}$, $T_A = 25^\circ\text{C}$.

§ The output conditions have been chosen to produce a current that closely approximates one half of the true short-circuit output current, I_{OS} .

switching characteristics (see Figure 1)

PARAMETER	FROM (INPUT)	TO (OUTPUT)	$V_{CC} = 4.5\text{ V to } 5.5\text{ V}$, $C_L = 50\text{ pF}$, $R_L = 500\ \Omega$, $T_A = \text{MIN to MAX}¶$				UNIT
			SN54ALS86		SN74ALS86		
			MIN	MAX	MIN	MAX	
t_{PLH}	A or B (other input low)	Y	3	22	3	17	ns
t_{PHL}			2	14	2	12	
t_{PLH}	A or B (other input high)	Y	3	22	3	17	ns
t_{PHL}			2	12	2	10	

¶ For conditions shown as MIN or MAX, use the appropriate value specified under recommended operating conditions.



SN54ALS86, SN54AS86A, SN74ALS86, SN74AS86A QUADRUPLE 2-INPUT EXCLUSIVE-OR GATES

SDAS006B – APRIL 1982 – REVISED DECEMBER 1994

absolute maximum ratings over operating free-air temperature range (unless otherwise noted)†

Supply voltage, V_{CC}	7 V
Input voltage, V_I	7 V
Operating free-air temperature range, T_A : SN54AS86A	-55°C to 125°C
SN74AS86A	0°C to 70°C
Storage temperature range	-65°C to 150°C

† Stresses beyond those listed under “absolute maximum ratings” may cause permanent damage to the device. These are stress ratings only, and functional operation of the device at these or any other conditions beyond those indicated under “recommended operating conditions” is not implied. Exposure to absolute-maximum-rated conditions for extended periods may affect device reliability.

recommended operating conditions

		SN54AS86A			SN74AS86A			UNIT
		MIN	NOM	MAX	MIN	NOM	MAX	
V_{CC}	Supply voltage	4.5	5	5.5	4.5	5	5.5	V
V_{IH}	High-level input voltage	2			2			V
V_{IL}	Low-level input voltage			0.8			0.8	V
I_{OH}	High-level output current			-2			-2	mA
I_{OL}	Low-level output current			20			20	mA
T_A	Operating free-air temperature	-55		125	0		70	°C

electrical characteristics over recommended operating free-air temperature range (unless otherwise noted)

PARAMETER	TEST CONDITIONS	SN54AS86A			SN74AS86A			UNIT
		MIN	TYP‡	MAX	MIN	TYP‡	MAX	
V_{IK}	$V_{CC} = 4.5\text{ V}$, $I_I = -18\text{ mA}$			-1.2			-1.2	V
V_{OH}	$V_{CC} = 4.5\text{ V to } 5.5\text{ V}$, $I_{OH} = -2\text{ mA}$	$V_{CC} - 2$			$V_{CC} - 2$			V
V_{OL}	$V_{CC} = 4.5\text{ V}$, $I_{OL} = 20\text{ mA}$		0.35	0.5		0.35	0.5	V
I_I	$V_{CC} = 5.5\text{ V}$, $V_I = 7\text{ V}$			0.1			0.1	mA
I_{IH}	$V_{CC} = 5.5\text{ V}$, $V_I = 2.7\text{ V}$			20			20	μA
I_{IL}	$V_{CC} = 5.5\text{ V}$, $V_I = 0.4\text{ V}$			-0.5			-0.5	mA
$I_{O§}$	$V_{CC} = 5.5\text{ V}$, $V_O = 2.25\text{ V}$		-30	-112		-30	-112	mA
I_{CCH}	$V_{CC} = 5.5\text{ V}$, $V_{I(A)} = 4.5\text{ V}$, $V_{I(B)} = 0$		11	18		11	18	mA
I_{CCL}	$V_{CC} = 5.5\text{ V}$, $V_I = 4.5\text{ V}$		20	38		20	38	mA

‡ All typical values are at $V_{CC} = 5\text{ V}$, $T_A = 25^\circ\text{C}$.

§ The output conditions have been chosen to produce a current that closely approximates one half of the true short-circuit output current, I_{OS} .

switching characteristics (see Figure 1)

PARAMETER	FROM (INPUT)	TO (OUTPUT)	$V_{CC} = 4.5\text{ V to } 5.5\text{ V}$, $C_L = 50\text{ pF}$, $R_L = 500\ \Omega$, $T_A = \text{MIN to MAX}^{\dagger\dagger}$				UNIT
			SN54AS86A		SN74AS86A		
			MIN	MAX	MIN	MAX	
t_{PLH}	A or B (other input low)	Y	2	8.5	2	7.5	ns
t_{PHL}			2	8	2	6.5	
t_{PLH}	A or B (other input high)	Y	1	8	1	6.5	ns
t_{PHL}			1	9	1	7	

†† For conditions shown as MIN or MAX, use the appropriate value specified under recommended operating conditions.



PARAMETER MEASUREMENT INFORMATION
 SERIES 54ALS/74ALS AND 54AS/74AS DEVICES

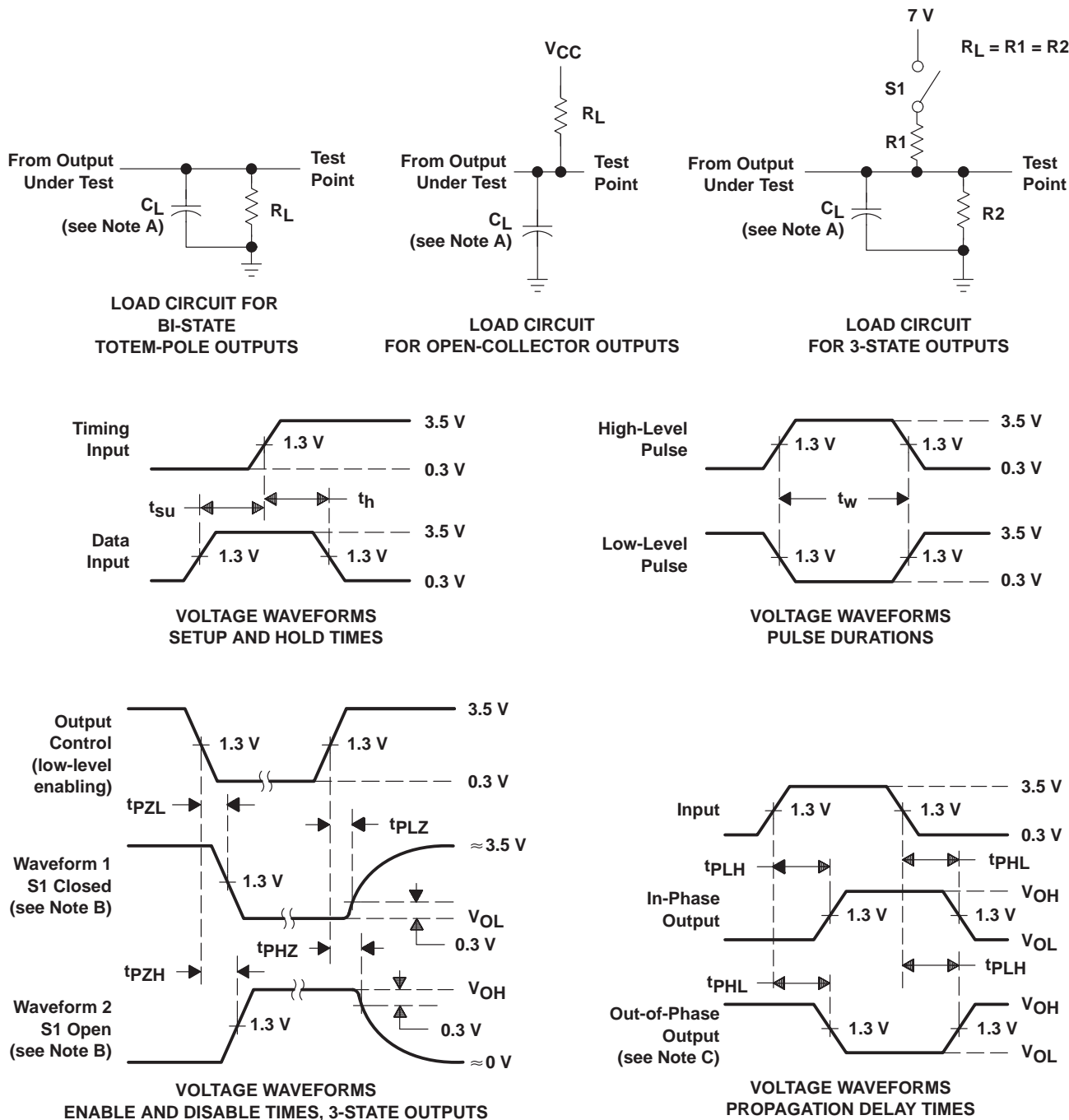

- NOTES: A. C_L includes probe and jig capacitance.
 B. Waveform 1 is for an output with internal conditions such that the output is low except when disabled by the output control. Waveform 2 is for an output with internal conditions such that the output is high except when disabled by the output control.
 C. When measuring propagation delay items of 3-state outputs, switch S1 is open.
 D. All input pulses have the following characteristics: $PRR \leq 1$ MHz, $t_r = t_f = 2$ ns, duty cycle = 50%.
 E. The outputs are measured one at a time with one transition per measurement.

Figure 1. Load Circuits and Voltage Waveforms

IMPORTANT NOTICE

Texas Instruments and its subsidiaries (TI) reserve the right to make changes to their products or to discontinue any product or service without notice, and advise customers to obtain the latest version of relevant information to verify, before placing orders, that information being relied on is current and complete. All products are sold subject to the terms and conditions of sale supplied at the time of order acknowledgement, including those pertaining to warranty, patent infringement, and limitation of liability.

TI warrants performance of its semiconductor products to the specifications applicable at the time of sale in accordance with TI's standard warranty. Testing and other quality control techniques are utilized to the extent TI deems necessary to support this warranty. Specific testing of all parameters of each device is not necessarily performed, except those mandated by government requirements.

CERTAIN APPLICATIONS USING SEMICONDUCTOR PRODUCTS MAY INVOLVE POTENTIAL RISKS OF DEATH, PERSONAL INJURY, OR SEVERE PROPERTY OR ENVIRONMENTAL DAMAGE ("CRITICAL APPLICATIONS"). TI SEMICONDUCTOR PRODUCTS ARE NOT DESIGNED, AUTHORIZED, OR WARRANTED TO BE SUITABLE FOR USE IN LIFE-SUPPORT DEVICES OR SYSTEMS OR OTHER CRITICAL APPLICATIONS. INCLUSION OF TI PRODUCTS IN SUCH APPLICATIONS IS UNDERSTOOD TO BE FULLY AT THE CUSTOMER'S RISK.

In order to minimize risks associated with the customer's applications, adequate design and operating safeguards must be provided by the customer to minimize inherent or procedural hazards.

TI assumes no liability for applications assistance or customer product design. TI does not warrant or represent that any license, either express or implied, is granted under any patent right, copyright, mask work right, or other intellectual property right of TI covering or relating to any combination, machine, or process in which such semiconductor products or services might be or are used. TI's publication of information regarding any third party's products or services does not constitute TI's approval, warranty or endorsement thereof.