



---

---

**CONTENTS**

---

---

<b>1. INTRODUCTION.....</b>	<b>3</b>
<b>2. FEATURES .....</b>	<b>3</b>
<b>3. BLOCK DIAGRAM .....</b>	<b>4</b>
<b>4. PIN ASSIGNMENT.....</b>	<b>4</b>
<b>5. FUNCTION DESCRIPTIONS .....</b>	<b>5</b>
5.1. OSCILLATOR .....	5
5.2. ROM .....	5
5.3. RAM .....	5
5.4. POWER DOWN MODE.....	5
5.5. SAMPLING RATE COUNTERS .....	5
5.6. AUTO REPETITION .....	6
5.7. WAVE MARK .....	6
5.8. PUSH-PULL OUTPUT .....	6
5.9. VOLUME CONTROL FUNCTION.....	6
5.10. WATCH DOG .....	7
5.11. I/O PORTS .....	7
5.12. PULL-LOW RESISTER CONTROL.....	7
5.13. IR FUNCTION .....	7
<b>6. ABSOLUTE MAXIMUM RATING .....</b>	<b>8</b>
<b>7. ELECTRICAL CHARACTERISTICS .....</b>	<b>8</b>
<b>8. APPLICATION CIRCUIT .....</b>	<b>9</b>
<b>9. DISCLAIMER.....</b>	<b>11</b>



**AMENDMENT HISTORY**

<b>Version</b>	<b>Date</b>	<b>Description</b>
Ver 1.0		First issue
Ver 1.1	May 25,2005	Add RST pin Description



## **1. INTRODUCTION**

SN56030 is a 30 seconds single chip 4-channel voice synthesizer IC which contains I/O pins and a tiny controller. By programming through the tiny controller, users' applications including section combination, trigger modes, output status, high performance melody, multiple voices, and other logic functions can be implemented.

## **2. FEATURES**

- ◆ Single power supply 2.4V – 5.5V
- ◆ Built in a tiny controller
- ◆ 30 seconds voice capacity are provided
- ◆ 128\*4 bits RAM are provided
- ◆ ROM Size
  - Maximum 96K\*10 bits ROM size
  - 64K program ROM is provided
- ◆ Readable ROM code data
- ◆ I/O Ports
  - Four 4-bit I/O ports P1, P2, P3, P6
  - The driving/sink current of P3.2 & P3.3 are 8mA/16mA
  - The IO pins P3.3 can be modulated with 38.5Khz carry signal to implement IR function.
- ◆ Built in a high quality speech synthesizer
- ◆ Four independent voice channels
- ◆ Adaptive playing speed from 4k-40kHz is provided for all 4 channels individually
- ◆ Automatic repetition for every channel
- ◆ A 6-bit\*8-bit Multiplier is embed to modulate the volume of synthesized voices
- ◆ Two digital mixers (with saturation control) are provided
- ◆ Built in an 8-level volume control Analog Push-Pull Direct Drive circuit.
- ◆ System clock: 2M Hz (RC-type or Crystal Option)
- ◆ Low Voltage Reset
- ◆ Built-in WDT function
- ◆ Built-in Event Mark Function

### 3. Block Diagram

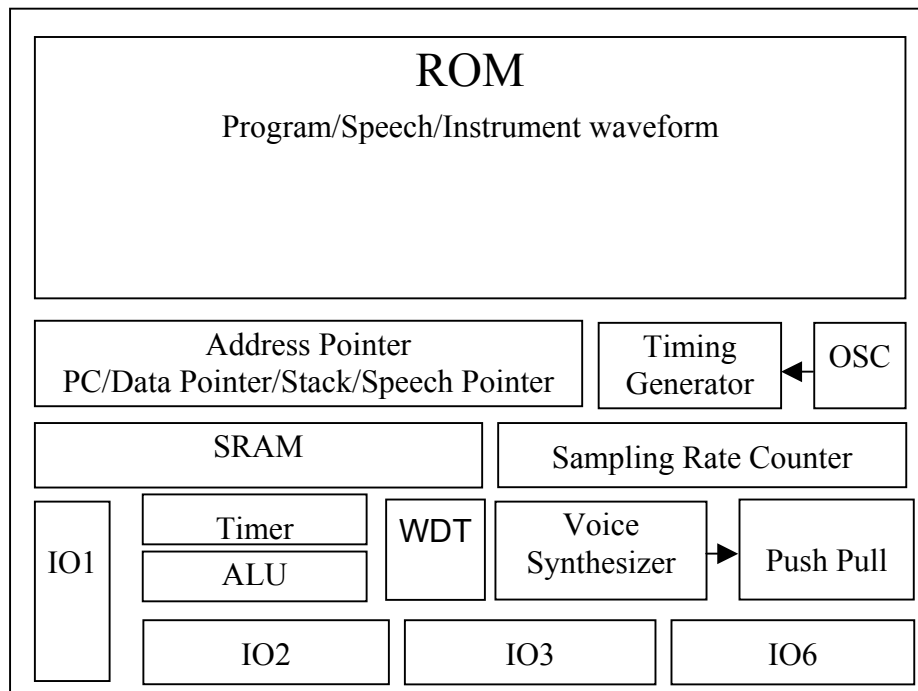

### 4. PIN ASSIGNMENT

Symbol	I/O	Function Description
P13, P12, P11, P10	I/O	Bit3 ~ Bit0 of I/O port 1
P23, P22, P21, P20	I/O	Bit3 ~ Bit0 of I/O port 2
P33, P32, P31, P30	I/O	Bit3 ~ Bit0 of I/O port 3
P63, P62, P61, P60	I/O	Bit3 ~ Bit0 of I/O port 6
VDD	I	Positive power supply
GND	I	Negative power supply
OSC/XIN	I	Oscillator / Crystal In
XOUT	O	Crystal Out / 1Khz output
CKSEL	I	Clock type select 'L' or floating → RC oscillator 'H' →Crystal
BUO1	O	Positive Output of Push Pull
BUO2	O	Negative Output of Push Pull
RST	I	RST=1 → Reset Chip (Active H)

## 5. FUNCTION DESCRIPTIONS

### 5.1. Oscillator

SN56000 series accepts crystal oscillator / ceramic resonator or RC type oscillator (selected by pin CKSEL) for system clock. The typical circuit diagrams for oscillator are listed as follows.

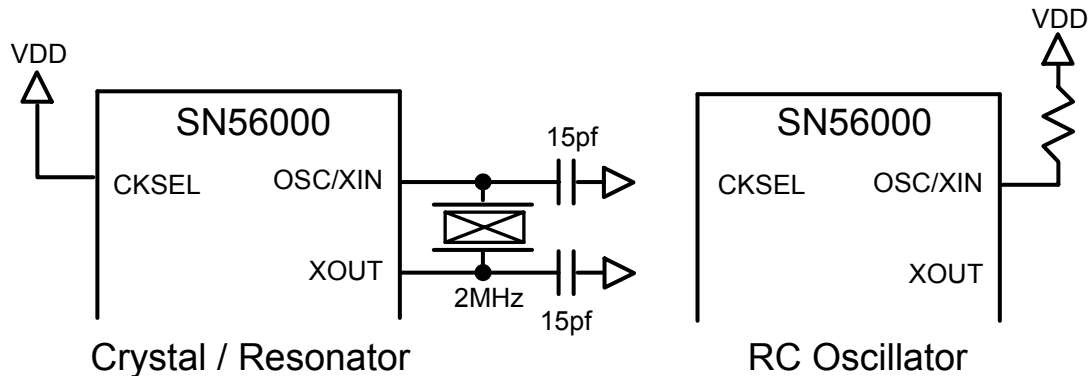

### 5.2. ROM

SN56030 contains 96K word (10-bit) internal ROM. Program, voices, melodies, data, and instrument waveforms share the same ROM with the others.

### 5.3. RAM

SN56000 series contains 128 nibble RAM. The 128 nibble RAM is separated into eight pages (page 0, page1... page 7). An implicit page indicator is utilized to specify page address. Eight instructions, PAGE0, PAGE1... PAGE7 can switch the page indicator. All 16 nibbles of each page can be accessed by direct mode (to specify M0 ~ M15 in the data transfer type instructions.)

### 5.4. Power Down Mode

“End” instruction will let SN56000 series enter power down mode and consumer very little amount of current. (<2uA @VDD=3V and <5uA @VDD=5V) After SN56030 enters power down mode, any valid data transition (L→H or H→L) occurring on any input ports or IO ports (P1, P2, P3 and P6) lead SN56000 series back to normal operation mode.

### 5.5. Sampling Rate Counters

4 independent sampling rate counters are dedicated to 4 individual voice channels to play voices with different playing rates. The playing rate is programmable from 4KHz to 40KHz. The resolution of sampling period of each sampling rate counter is 0.25 uS. This feature helps SN56000 series play sounds with accurate pitches in the case of music instrument synthesis.

### 5.6. Auto repetition

Auto repetition function helps SN56000 series realize a “looping” sound automatically by hardware without any software effort. Auto repetition function is a very useful mechanism to implement “Sustain” sound in instrument synthesis. All 4 channels are equipped with this function. Arbitrary lengths of looping sound are accepted by SN56000 series.

### 5.7. Wave Mark

This is a new function for SN56000 series, it allows user to add a special mark in wave data by the voice edit tool “CoolEdit”, “Goldwav”, “SoundForge”. User can insert event tags in anywhere of his wave file and can easy to get this special code to do his special action during voice playing. That means, it should be easily to control the I/O (such as LED or Motor) and other actions to synchronize with voice.

### 5.8. Push-Pull output

A Push-Pull Direct Drive circuit is built-in SN56030. The maximum resolution of Push-Pull is 8 bits (8 bit structure with LSB set to 0). Two huge output stage circuits are designed in SN56030. With this advanced circuit, the chip is capable of driving speaker directly without external transistors.

### 5.9. Volume Control Function

Bit0~Bit2 of VOL Register is applied to control the volume of voice. The relationship between output current and mode2 register is listed in the following table (power on set to 111). Bit3 of VOL register provide for VOL Output division 2.

Bit2	Bit1	Bit0	Output Volume
0	0	0	46.5 DB
0	0	1	52.2 DB
0	1	0	58.1 DB
0	1	1	63.9 DB
1	0	0	70.3 DB
1	0	1	77.2 DB
1	1	0	82.3 DB
1	1	1	88.0 DB

### 5.10. Watch Dog

This is a new function for SN56000 series. The WDT is cascade after system timer. When user reset system timer will issue a clear signal to WDT also. It would issue a reset signal to chip if user doesn't reset any system timer before it reach terminate count (1 Second) when chip is in active mode.

### 5.11. I/O Ports

P1/P2/P3/P6 are four 4-bit I/O ports. Any bit of P1/P2/P3/P6 can be programmed to be input or output individually. Any valid data transition (H→L or L→H) of P1, P2, P3 and P6 can reactivate the chip when it is in power-down stage.

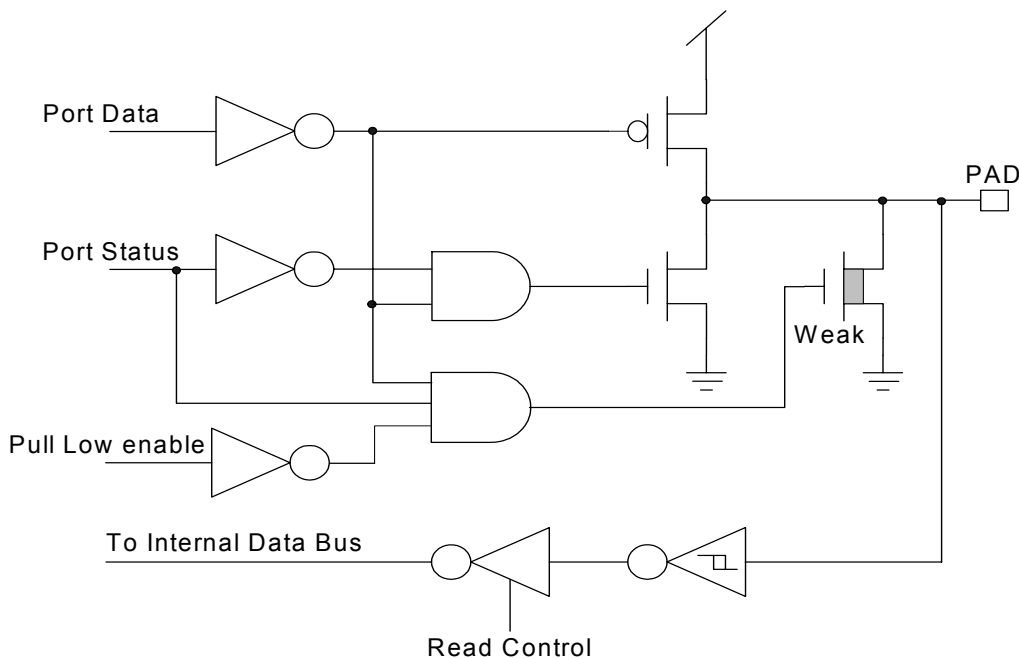

**I/O Port Configuration (P10~P13, P20~P23, P30~P33, P60~P63)**

**Note: All weak N-MOS's can serve as pull-low resistors.**

### 5.12. Pull-Low Resister Control

This function provides user to control Pull-Low register of all I/O ports that can be disabled by user command. With the help of this function, input floating and input pull low is supported.

### 5.13. IR Function

P33 can be modulated with 38.5KHz square wave before sent out to P33 pin. The IR signal can be achieved by this modulated signal.

## 6. ABSOLUTE MAXIMUM RATING

Items	Symbol	Min	Max	Unit.
Supply Voltage	$V_{DD-V}$	-0.3	6.0	V
Input Voltage	$V_{IN}$	$V_{SS}-0.3$	$V_{DD}+0.3$	V
Operating Temperature	$T_{OP}$	0	55.0	°C
Storage Temperature	$T_{STG}$	-55.0	125.0	°C

## 7. ELECTRICAL CHARACTERISTICS

Item	Sym.	Min.	Typ.	Max.	Unit	Condition
Operating Voltage	$V_{DD}$	2.4	3.0	5.5	V	
Standby Current	$I_{SBY}$	-	2.0	-	uA	$V_{DD}=3V$ , no load
Operating Current	$I_{OPR}$	-	350	-	uA	$V_{DD}=3V$ , no load
Operating Current	$I_{OPR}$	-	4.4	-	mA	$V_{DD}=3V$ , Push-Pull turn on , no load
Input Current of P10~P13, P20~P23, P30~P33, P60~P63	$I_i$	-	3	-	uA	$V_{DD}=3V$
Drive Current of P10~P13, P20~P23, P30~P31, P60~P63	$I_{OD}$	-	4	-	mA	$V_{DD}=3V, V_O=2.4V$
Sink Current of P10~P13, P20~P23, P30~P31, P60~P63	$I_{OS}$	-	6	-	mA	$V_{DD}=3V, V_O=0.4V$
Drive Current of P32~P33	$I_{OD}$	-	8	-	mA	$V_{DD}=3V, V_O=2.4V$
Sink Current of P32~P33	$I_{OS}$	-	16	-	mA	$V_{DD}=3V, V_O=0.4V$
Drive current of Buo1/Buo2	$I_{BUD}$	-	80	-	mA	$V_{DD}=3V, Buo_x=1.5V$ Sine wav Full Amplitude
Sink Current of Buo1/Buo2	$I_{BUS}$	-	80	-	mA	$V_{DD}=3V, Buo_x=1.5V$ Sine wav Full Amplitude
Oscillation Freq.	$F_{OSC}$	-	2.0	-	MHz	$V_{DD}=3V$



## 8. APPLICATION CIRCUIT

System Clock: 2MHZ ROOSC

Keys: 32 Scan Keys

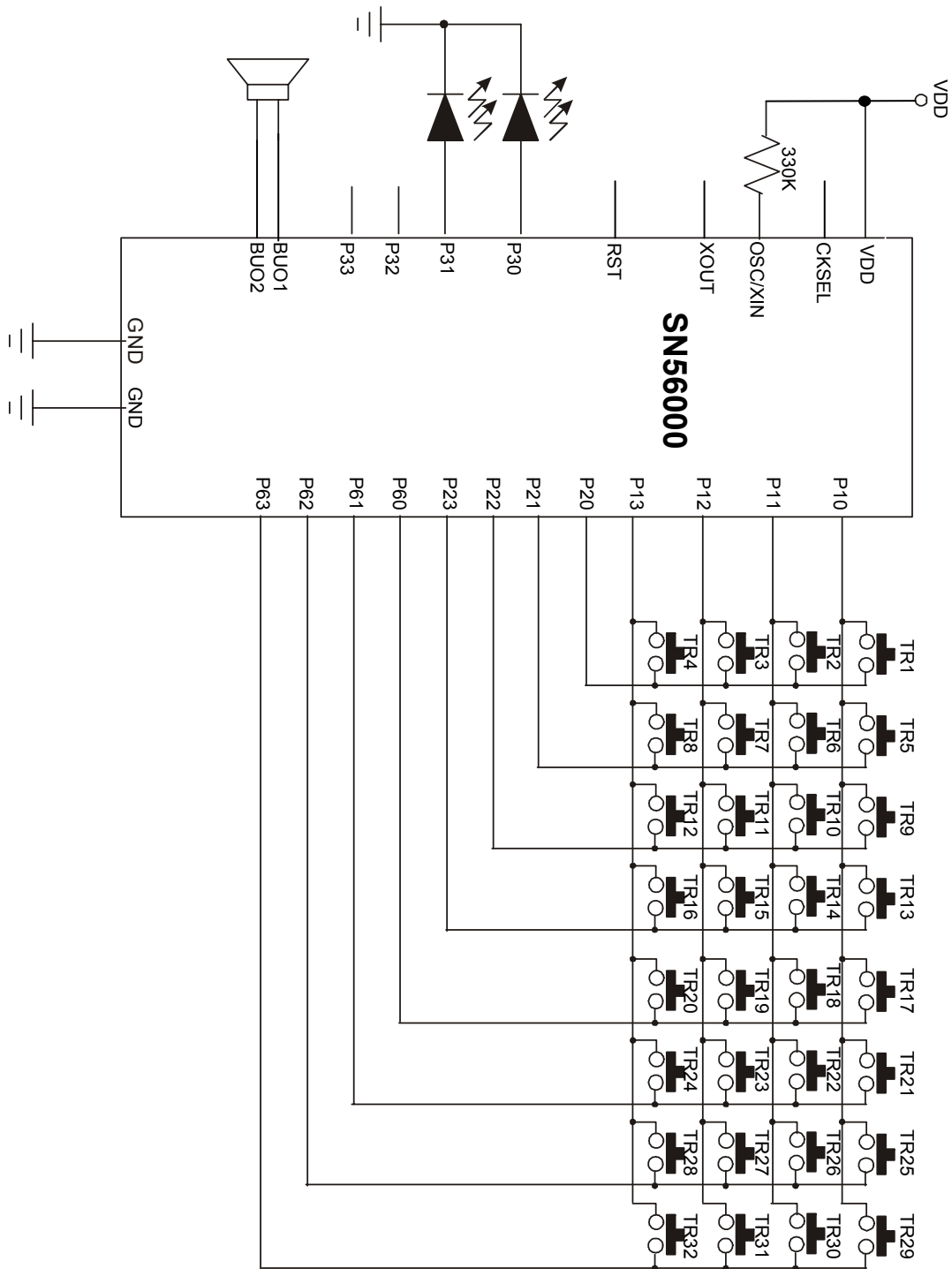



System Clock: 2MHz Crystal  
Keys: 32 Scan Keys

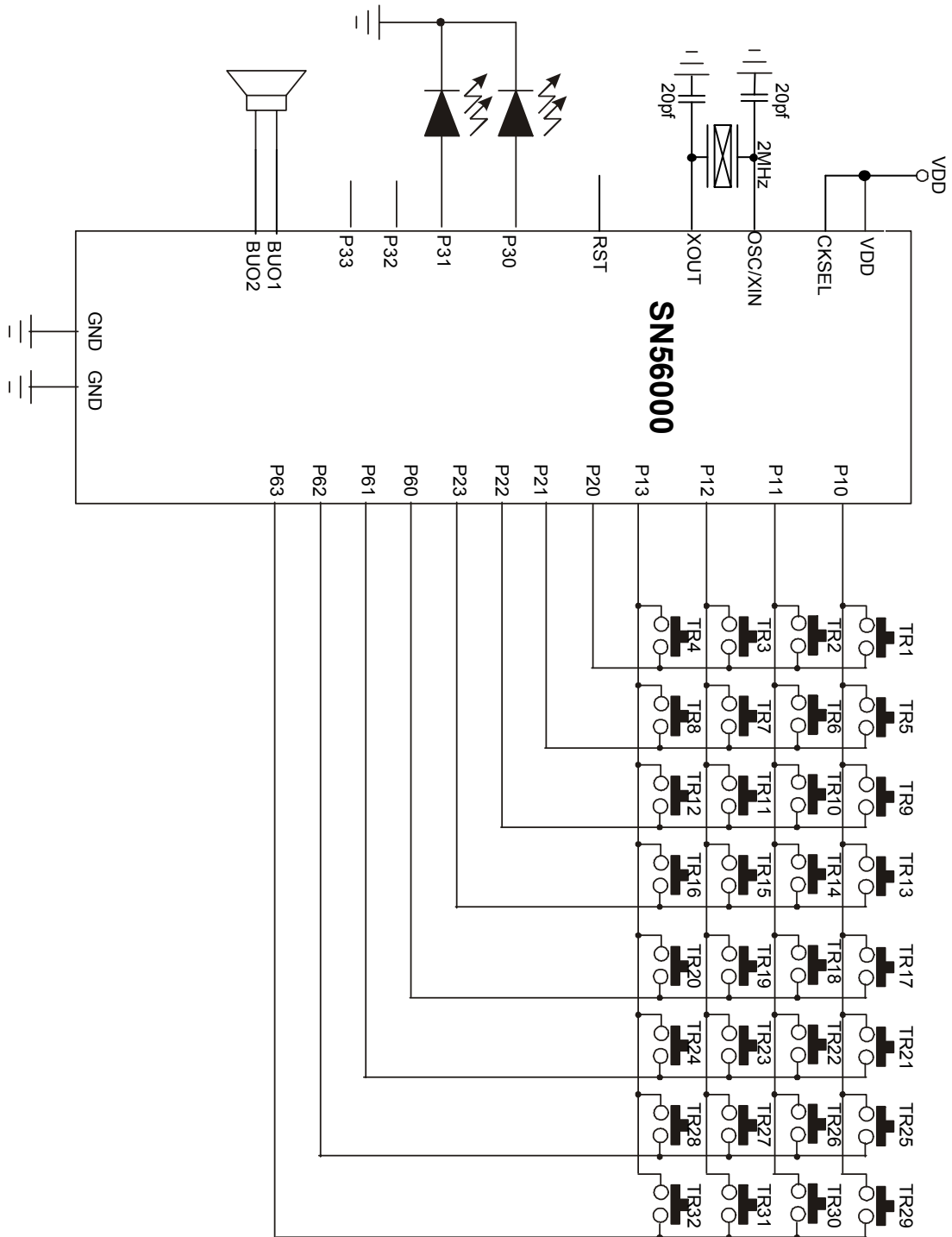

## **9. DISCLAIMER**

The information appearing in SONIX web pages (“this publication”) is believed to be accurate.

However, this publication could contain technical inaccuracies or typographical errors. The reader should not assume that this publication is error-free or that it will be suitable for any particular purpose. SONIX makes no warranty, express, statutory implied or by description in this publication or other documents which are referenced by or linked to this publication. In no event shall SONIX be liable for any special, incidental, indirect or consequential damages of any kind, or any damages whatsoever, including, without limitation, those resulting from loss of use, data or profits, whether or not advised of the possibility of damage, and on any theory of liability, arising out of or in connection with the use or performance of this publication or other documents which are referenced by or linked to this publication.

This publication was developed for products offered in Taiwan. SONIX may not offer the products discussed in this document in other countries. Information is subject to change without notice. Please contact SONIX or its local representative for information on offerings available. Integrated circuits sold by SONIX are covered by the warranty and patent indemnification provisions stipulated in the terms of sale only. The application circuits illustrated in this document are for reference purposes only. SONIX DISCLAIMS ALL WARRANTIES, INCLUDING THE WARRANTY OF MERCHANTABILITY OR FITNESS FOR ANY PURPOSE. SONIX reserves the right to halt production or alter the specifications and prices, and discontinue marketing the Products listed at any time without notice. Accordingly, the reader is cautioned to verify that the data sheets and other information in this publication are current before placing orders.

Products described herein are intended for use in normal commercial applications. Applications involving unusual environmental or reliability requirements, e.g. military equipment or medical life support equipment, are specifically not recommended without additional processing by SONIX for such application.