

SIPMOS[®] Small-Signal-Transistor

Feature

- N-Channel
- Enhancement mode
- Logic Level
- dv/dt rated
- Pb-free lead plating; RoHS compliant
- Qualified according to AEC Q101
- Halogen-free according to IEC61249-2-21



Product Summary

V_{DS}	60	V
$R_{DS(on)}$	5	Ω
I_D	0.2	A

PG-SOT-23

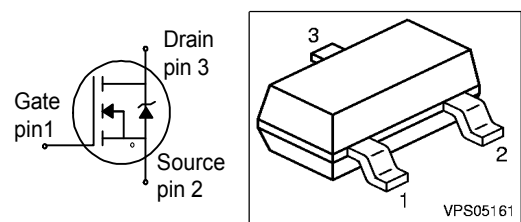

Type	Package	Pb-free	Tape and Reel Information	Marking
SN7002N	PG-SOT-23	Yes	H6327: 3000 pcs/reel	sSN
SN7002N	PG-SOT-23	Yes	H6433: 10000 pcs/reel	sSN

Maximum Ratings, at $T_j = 25^\circ\text{C}$, unless otherwise specified

Parameter	Symbol	Value	Unit
Continuous drain current	I_D		A
$T_A=25^\circ\text{C}$		0.2	
$T_A=70^\circ\text{C}$		0.16	
Pulsed drain current	$I_{D \text{ puls}}$	0.8	
$T_A=25^\circ\text{C}$			
Reverse diode dv/dt	dv/dt	6	kV/ μs
$I_S=0.2\text{A}$, $V_{DS}=48\text{V}$, $di/dt=200\text{A}/\mu\text{s}$, $T_{jmax}=150^\circ\text{C}$			
Gate source voltage	V_{GS}	± 20	V
ESD Class (JESD22-A114-HBM)		0 (<250V)	
Power dissipation	P_{tot}	0.36	W
$T_A=25^\circ\text{C}$			
Operating and storage temperature	T_j, T_{stg}	-55... +150	$^\circ\text{C}$
IEC climatic category; DIN IEC 68-1		55/150/56	

Thermal Characteristics

Parameter	Symbol	Values			Unit
		min.	typ.	max.	
Characteristics					
Thermal resistance, junction - ambient at minimal footprint	R_{thJA}	-	-	350	K/W

Electrical Characteristics, at $T_j = 25^\circ\text{C}$, unless otherwise specified

Parameter	Symbol	Values			Unit
		min.	typ.	max.	
Static Characteristics					
Drain-source breakdown voltage $V_{GS}=0, I_D=250\mu\text{A}$	$V_{(BR)DSS}$	60	-	-	V
Gate threshold voltage, $V_{GS} = V_{DS}$ $I_D=26\mu\text{A}$	$V_{GS(th)}$	0.8	1.4	1.8	
Zero gate voltage drain current $V_{DS}=60\text{V}, V_{GS}=0, T_j=25^\circ\text{C}$ $V_{DS}=60\text{V}, V_{GS}=0, T_j=150^\circ\text{C}$	I_{DSS}	-	-	0.1 5	μA
Gate-source leakage current $V_{GS}=20\text{V}, V_{DS}=0$	I_{GSS}	-	-	10	nA
Drain-source on-state resistance $V_{GS}=4.5\text{V}, I_D=0.17\text{A}$	$R_{DS(on)}$	-	3.9	7.5	Ω
Drain-source on-state resistance $V_{GS}=10\text{V}, I_D=0.5\text{A}$	$R_{DS(on)}$	-	2.5	5	

Electrical Characteristics, at $T_j = 25\text{ }^\circ\text{C}$, unless otherwise specified

Parameter	Symbol	Conditions	Values			Unit
			min.	typ.	max.	
Dynamic Characteristics						
Transconductance	g_{fs}	$V_{DS} \geq 2 \cdot I_D \cdot R_{DS(on)max}$, $I_D = 0.16\text{A}$	0.09	0.17	-	S
Input capacitance	C_{iss}	$V_{GS} = 0$, $V_{DS} = 25\text{V}$, $f = 1\text{MHz}$	-	34	45	pF
Output capacitance	C_{oss}		-	7.2	9.6	
Reverse transfer capacitance	C_{rss}		-	2.8	4.2	
Turn-on delay time	$t_{d(on)}$	$V_{DD} = 30\text{V}$, $V_{GS} = 10\text{V}$, $I_D = 0.5\text{A}$, $R_G = 6\Omega$	-	2.4	3.6	ns
Rise time	t_r		-	3.2	4.8	
Turn-off delay time	$t_{d(off)}$		-	5.3	8	
Fall time	t_f		-	3.6	5.4	
Gate Charge Characteristics						
Gate to source charge	Q_{gs}	$V_{DD} = 48\text{V}$, $I_D = 0.5\text{A}$	-	0.14	0.21	nC
Gate to drain charge	Q_{gd}		-	0.42	0.63	
Gate charge total	Q_g	$V_{DD} = 48\text{V}$, $I_D = 0.5\text{A}$, $V_{GS} = 0$ to 10V	-	1	1.5	
Gate plateau voltage	$V_{(plateau)}$	$V_{DD} = 48\text{V}$, $I_D = 0.5\text{A}$	-	4.5	-	V
Reverse Diode						
Inverse diode continuous forward current	I_S	$T_A = 25\text{ }^\circ\text{C}$	-	-	0.2	A
Inv. diode direct current, pulsed	I_{SM}		-	-	0.8	
Inverse diode forward voltage	V_{SD}	$V_{GS} = 0$, $I_F = I_S$	-	0.83	1.2	V
Reverse recovery time	t_{rr}	$V_R = 30\text{V}$, $I_F = I_S$, $di_F/dt = 100\text{A}/\mu\text{s}$	-	14.2	21.3	ns
Reverse recovery charge	Q_{rr}		-	5.9	8.8	

1 Power dissipation

$$P_{tot} = f(T_A)$$

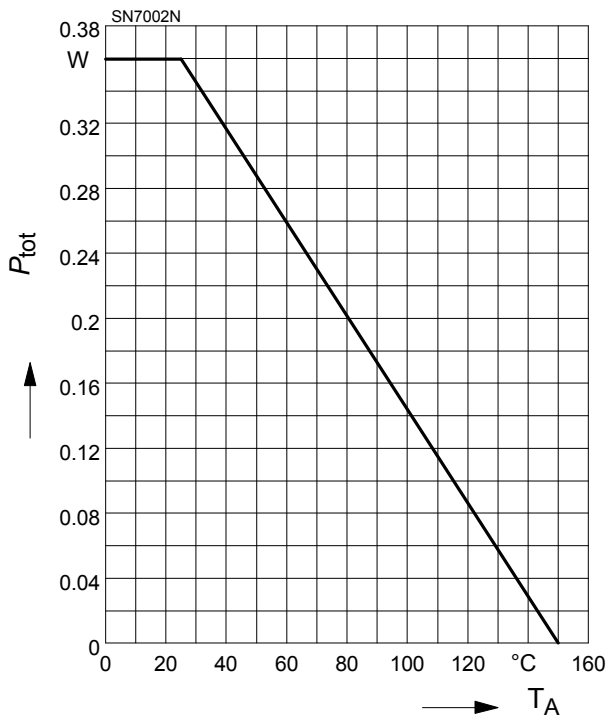

2 Drain current

$$I_D = f(T_A)$$

parameter: $V_{GS} \geq 10\text{ V}$

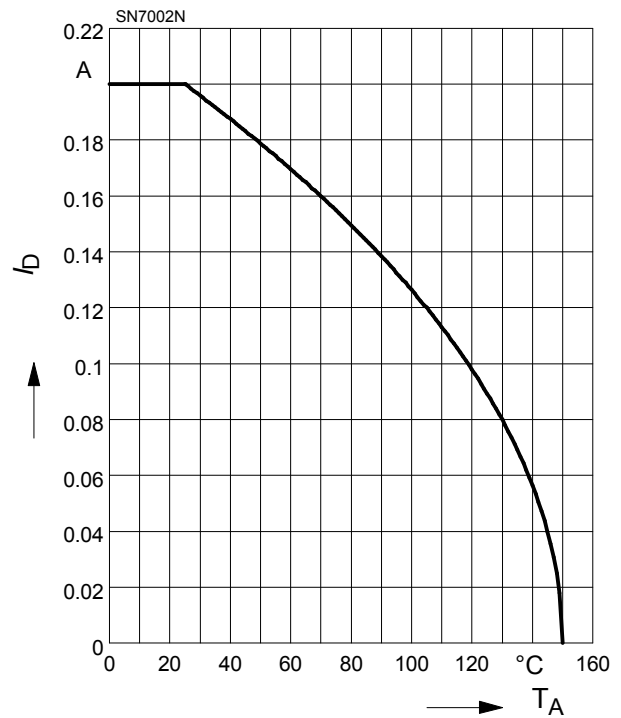

3 Safe operating area

$$I_D = f(V_{DS})$$

parameter: $D = 0$, $T_A = 25\text{ °C}$

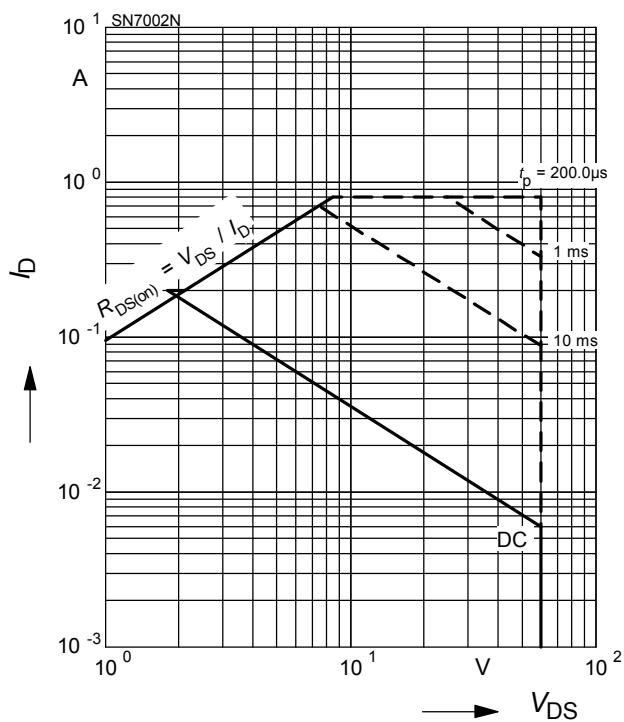

4 Transient thermal impedance

$$Z_{thJA} = f(t_p)$$

parameter: $D = t_p/T$

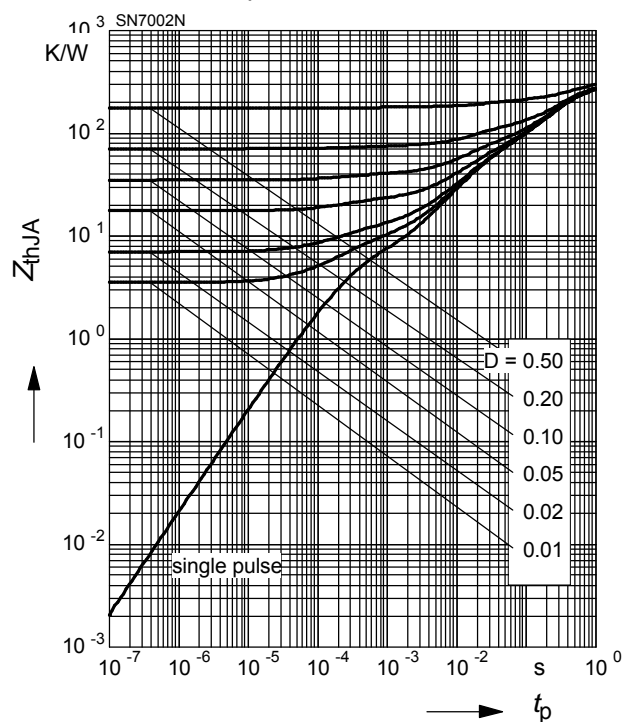

5 Typ. output characteristic

$$I_D = f(V_{DS})$$

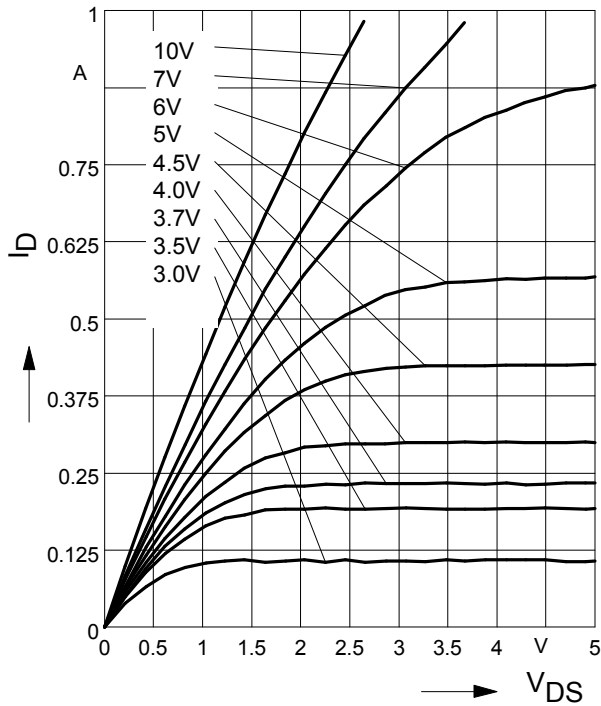
 parameter: $T_j = 25\text{ }^\circ\text{C}$, V_{GS}

6 Typ. drain-source on resistance

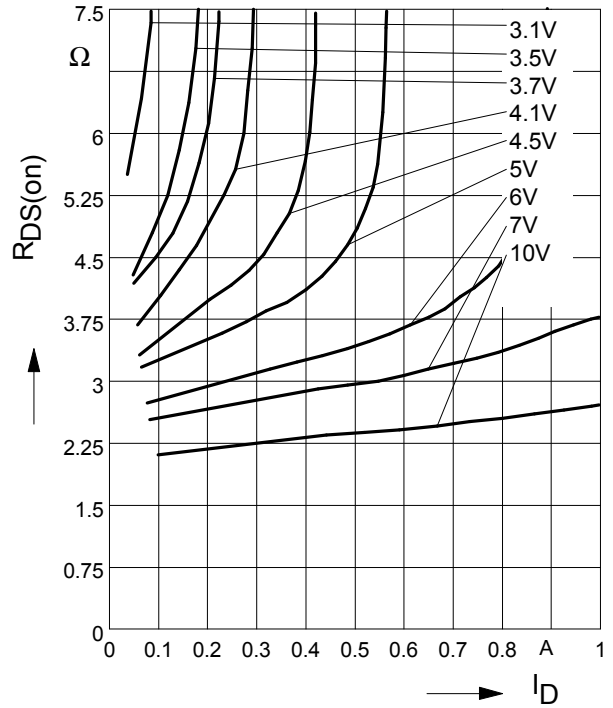
$$R_{DS(on)} = f(I_D)$$

 parameter: $T_j = 25\text{ }^\circ\text{C}$, V_{GS}

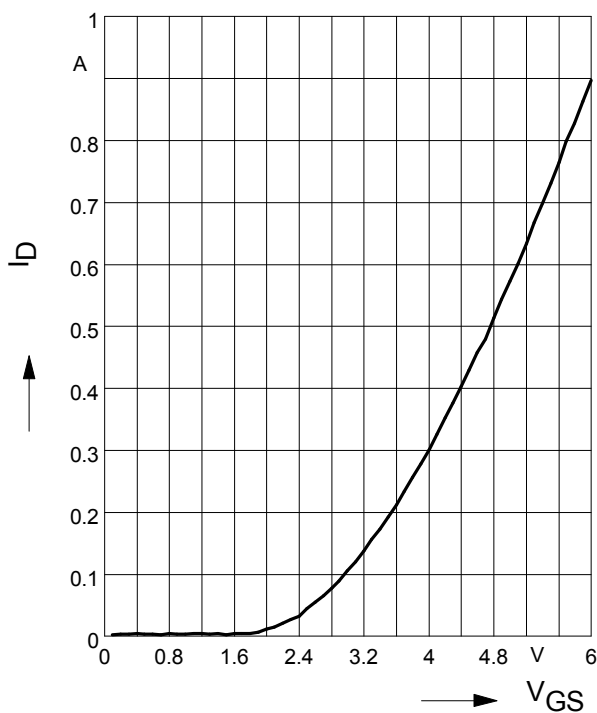
7 Typ. transfer characteristics

$$I_D = f(V_{GS}); V_{DS} \geq 2 \times I_D \times R_{DS(on)max}$$

 parameter: $T_j = 25\text{ }^\circ\text{C}$

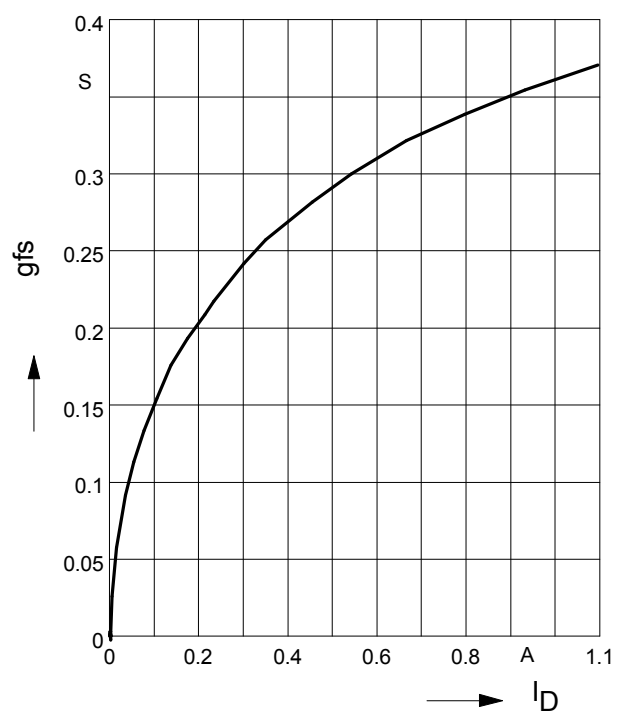
8 Typ. forward transconductance

$$g_{fs} = f(I_D)$$

 parameter: $T_j = 25\text{ }^\circ\text{C}$

9 Drain-source on-state resistance

$$R_{DS(on)} = f(T_j)$$

parameter : $I_D = 0.5 \text{ A}$, $V_{GS} = 10 \text{ V}$

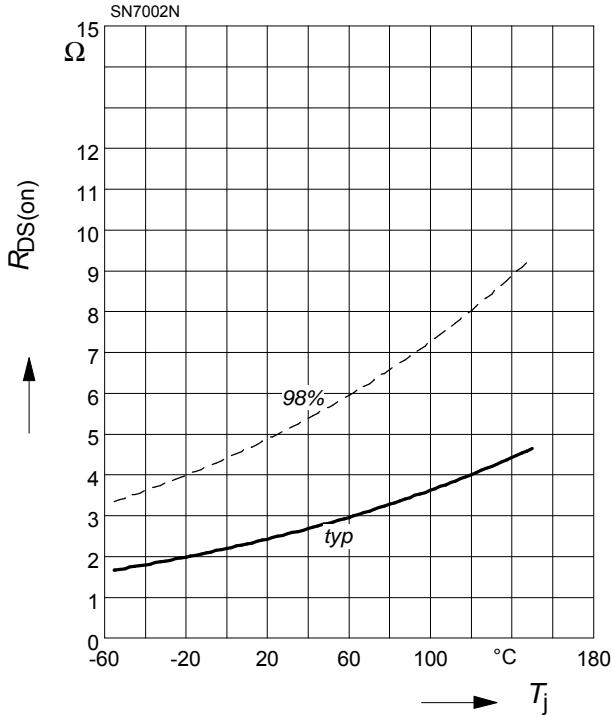

10 Typ. gate threshold voltage

$$V_{GS(th)} = f(T_j)$$

parameter: $V_{GS} = V_{DS}$; $I_D = 26\mu\text{A}$

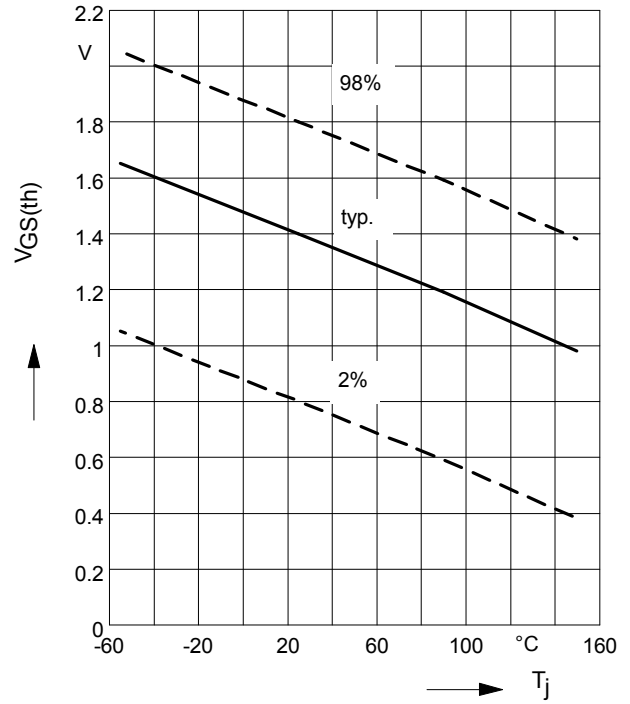

11 Typ. capacitances

$$C = f(V_{DS})$$

parameter: $V_{GS}=0$, $f=1 \text{ MHz}$, $T_j = 25 \text{ }^\circ\text{C}$

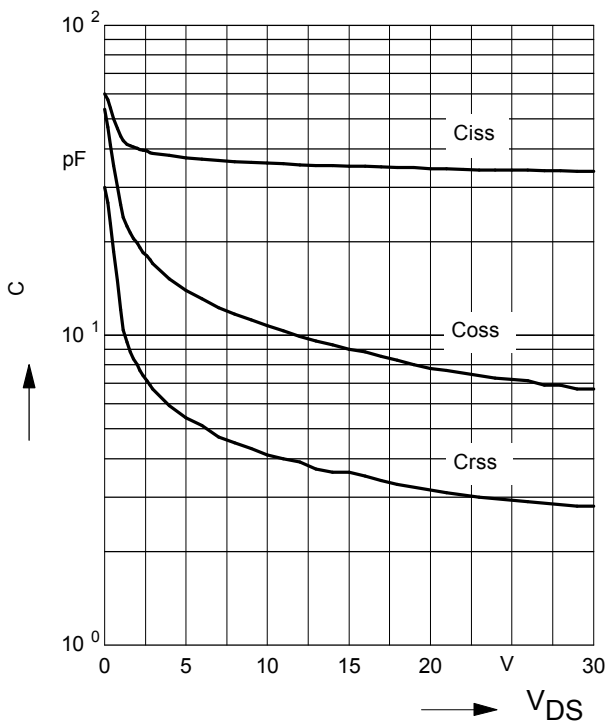

12 Forward character. of reverse diode

$$I_F = f(V_{SD})$$

parameter: T_j

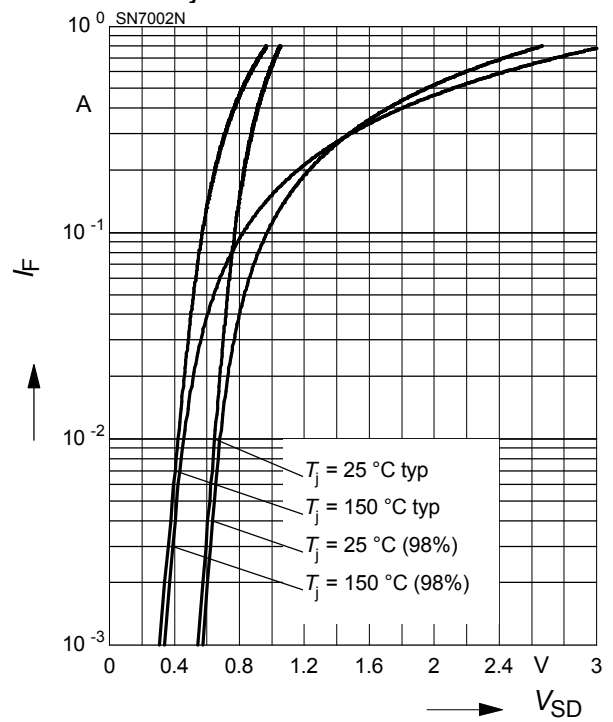

13 Typ. gate charge

$V_{GS} = f(Q_G)$; parameter: V_{DS} ,
 $I_D = 0.2 \text{ A pulsed}$, $T_j = 25 \text{ }^\circ\text{C}$

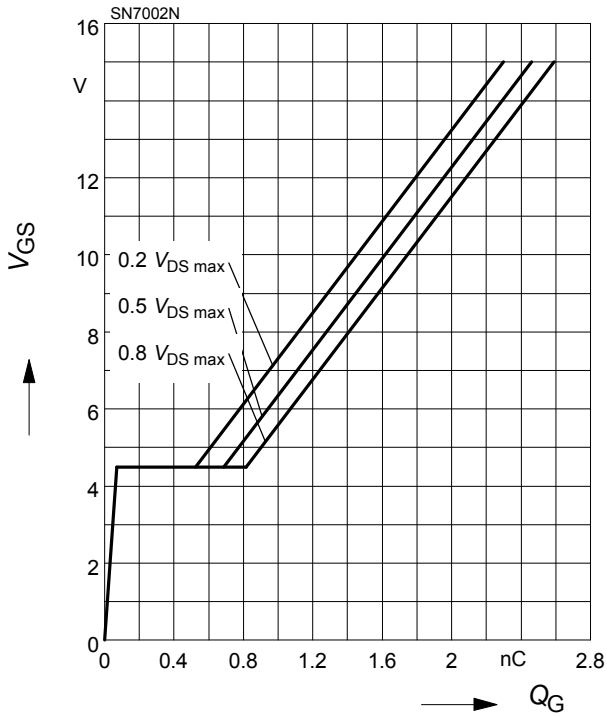

14 Drain-source breakdown voltage

$V_{(BR)DSS} = f(T_j)$

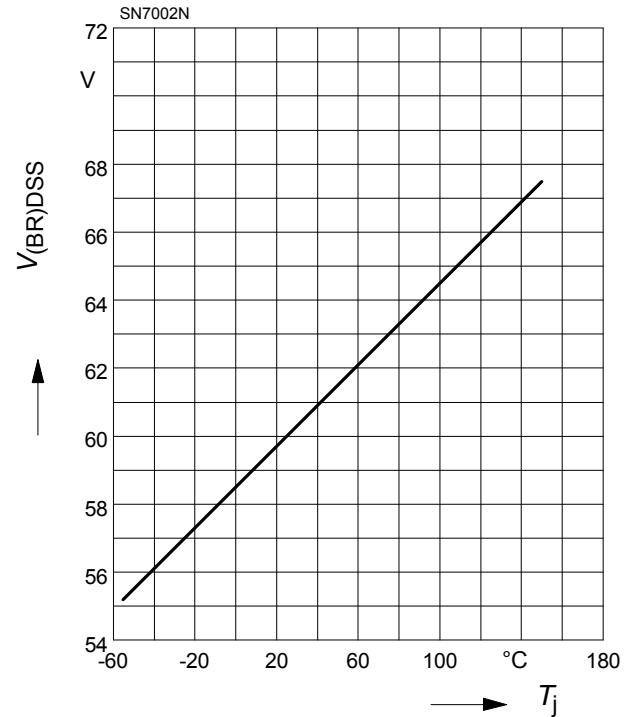

SOT23

Package Outline:

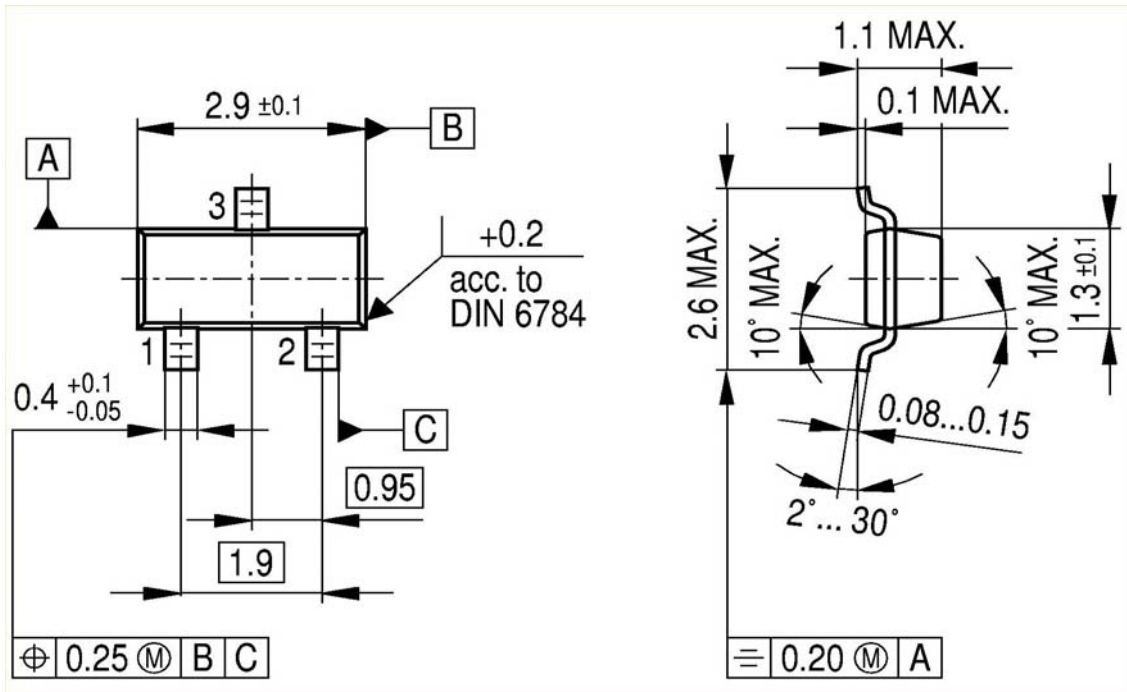

Footprint:

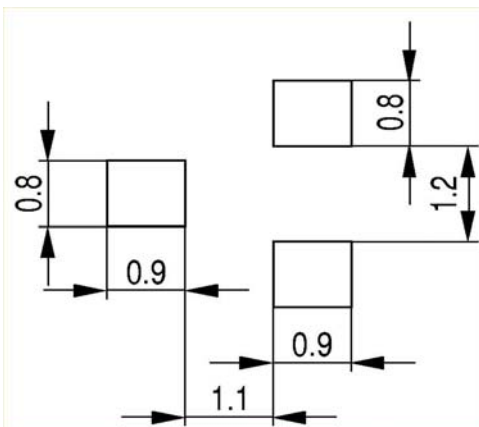

Packaging:

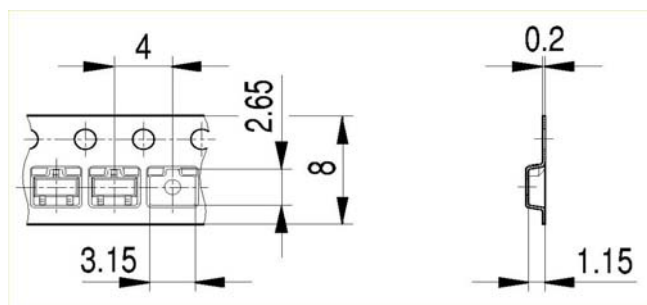

Dimensions in mm

Published by
Infineon Technologies AG
81726 Munich, Germany
© 2009 Infineon Technologies AG
All Rights Reserved.

Legal Disclaimer

The information given in this document shall in no event be regarded as a guarantee of conditions or characteristics. With respect to any examples or hints given herein, any typical values stated herein and/or any information regarding the application of the device, Infineon Technologies hereby disclaims any and all warranties and liabilities of any kind, including without limitation, warranties of non-infringement of intellectual property rights of any third party.

Information

For further information on technology, delivery terms and conditions and prices, please contact the nearest Infineon Technologies Office (www.infineon.com).

Warnings

Due to technical requirements, components may contain dangerous substances. For information on the types in question, please contact the nearest Infineon Technologies Office. Infineon Technologies components may be used in life-support devices or systems only with the express written approval of Infineon Technologies, if a failure of such components can reasonably be expected to cause the failure of that life-support device or system or to affect the safety or effectiveness of that device or system. Life support devices or systems are intended to be implanted in the human body or to support and/or maintain and sustain and/or protect human life. If they fail, it is reasonable to assume that the health of the user or other persons may be endangered.