

SN74AUP2G07 Low-Power Dual Buffer/Driver With Open-Drain Outputs

1 Features

- Low static-power consumption ($I_{CC} = 0.9 \mu\text{A}$ maximum)
- Low dynamic-power consumption ($C_{pd} = 1 \text{ pF}$ typical at 3.3 V)
- Low input capacitance ($C_i = 1.5 \text{ pF}$ typical)
- Low noise – overshoot and undershoot <math><10\%</math> of V_{CC}
- I_{off} supports live insertion, partial-power-down mode, and back-drive protection
- Input hysteresis allows slow input transition and better switching noise immunity at the input ($V_{hys} = 250 \text{ mV}$ typical at 3.3 V)
- Wide operating V_{CC} range of 0.8 V to 3.6 V
- Optimized for 3.3 V operation
- 3.6-V I/O tolerant to support mixed-mode signal operation
- $t_{pd} = 3.3 \text{ ns}$ maximum at 3.3 V
- Suitable for point-to-point applications
- Latch-up performance exceeds 100 mA per JESD 78, Class II
- ESD performance tested per JESD 22
 - 4500-V human-body model
 - 1500-V charged-device model

2 Applications

- Active noise cancellation (ANC)
- Barcode scanners
- Blood pressure monitors
- CPAP machines
- Cable solutions
- DLP 3D machine vision, hyperspectral imaging, optical networking, and spectroscopy
- E-books and smartphones
- Embedded PCs
- Field transmitters: temperature or pressure sensor
- Fingerprint biometrics
- HVAC: heating, ventilating, and air conditioning
- Network-attached storage (NAS)
- Server motherboards and PSUs
- Software defined radios (SDR)
- TVs: high-definition (HDTV), LCD, and digital
- Video communication systems
- Wireless data access cards, headsets, keyboards, mice, and LAN cards
- X-ray: baggage scanners, medical, and dental

3 Description

The SN74AUP2G07 device is a dual buffer gate with open drain output that operates from 0.8 V to 3.6 V.

Device Information

PART NUMBER	PACKAGE ⁽¹⁾	BODY SIZE (NOM)
SN74AUP2G07	SC70 (6)	3.00 mm × 1.25 mm
	SON (6)	1.45 mm × 1.00 mm
	SON (6)	1.00 mm × 1.00 mm
	DSBGA (6)	1.16 mm × 0.76 mm

(1) For all available packages, see the orderable addendum at the end of the data sheet.

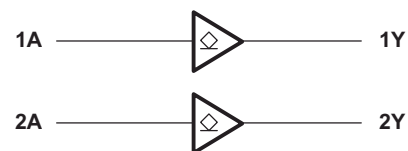

Simplified Block Diagram



Table of Contents

1 Features	1	8 Detailed Description	11
2 Applications	1	8.1 Overview.....	11
3 Description	1	8.2 Functional Block Diagram.....	11
4 Revision History	2	8.3 Feature Description.....	11
5 Pin Configuration and Functions	3	8.4 Device Functional Modes.....	11
6 Specifications	4	9 Application and Implementation	12
6.1 Absolute Maximum Ratings.....	4	9.1 Application Information.....	12
6.2 ESD Ratings.....	4	9.2 Typical Application.....	12
6.3 Recommended Operating Conditions.....	5	10 Power Supply Recommendations	13
6.4 Thermal Information.....	5	11 Layout	13
6.5 Electrical Characteristics.....	6	11.1 Layout Guidelines.....	13
6.6 Switching Characteristics, $C_L = 5$ pF.....	7	11.2 Layout Example.....	13
6.7 Switching Characteristics, $C_L = 10$ pF.....	7	12 Device and Documentation Support	14
6.8 Switching Characteristics, $C_L = 15$ pF.....	7	12.1 Receiving Notification of Documentation Updates..	14
6.9 Switching Characteristics, $C_L = 30$ pF.....	7	12.2 Support Resources.....	14
6.10 Operating Characteristics.....	8	12.3 Trademarks.....	14
6.11 Typical Characteristics.....	8	12.4 Electrostatic Discharge Caution.....	14
7 Parameter Measurement Information	9	12.5 Glossary.....	14
7.1 Propagation Delays, Setup and Hold Times, and Pulse Duration.....	9	13 Mechanical, Packaging, and Orderable Information	14
7.2 Enable and Disable Times.....	10		

4 Revision History

NOTE: Page numbers for previous revisions may differ from page numbers in the current version.

Changes from Revision D (February 2016) to Revision E (October 2021)	Page
• Changed pinout images style and formatting, removed overlapping letters in YZP package drawing, corrected BGA pin numbers in the <i>Pin Functions</i> table, changed V_{CC} and GND pin TYPE From: "—" To: "P" in the <i>Pin Functions</i> table and added footnote to the <i>Pin Functions</i> table to define pin types.....	3
• Changed maximum output voltage in the low state in the Section 6.1 table to 4.6 V.....	4
• Changed the V_O Output voltage in the Section 6.3 table from ' V_{CC} ' to '3.6'.....	5
• Updated $R_{\theta JA}$ values to more accurately reflect device characteristics: YFP 132 to 125.4, DCK 252 to 302.4, DRY 234 to 338, DSF 300 to 372.5, added standard thermal characteristics for all packages ($R_{\theta JC(top)}$, $R_{\theta JB}$, Ψ_{JT} , Ψ_{JB} , $R_{\theta JC(bot)}$).....	5
Changes from Revision C (November 2014) to Revision D (February 2016)	Page
• Changed the V_{CC} pin TYPE From: "I" To: "—" in the <i>Pin Functions</i> table.....	3
• Added "Junction temperature" to the Section 6.1 table.....	4
• Deleted the I_{OH} High-level output current from the Section 6.3 table.....	5
• Deleted V_{OH} PARAMETER from the Section 6.5 table, these specifications do not pertain to open drain devices.....	6
Changes from Revision B (September 2009) to Revision C (November 2014)	Page
• Removed <i>Ordering Information</i> table.....	1
• Added <i>Applications</i> , <i>Device Information</i> table, <i>Pin Functions</i> table, <i>Handling Ratings</i> table, <i>Thermal Information</i> table, <i>Typical Characteristics</i> , <i>Feature Description</i> section, <i>Device Functional Modes</i> , <i>Application and Implementation</i> section, <i>Power Supply Recommendations</i> section, <i>Layout</i> section, <i>Device and Documentation Support</i> section, and <i>Mechanical, Packaging, and Orderable Information</i> section.....	1
• Updated I_{off} in <i>Features</i>	1

5 Pin Configuration and Functions

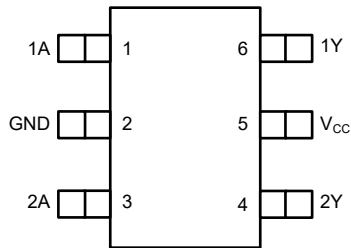

**Figure 5-1. DCK Package
6-Pin SC70
Top View**

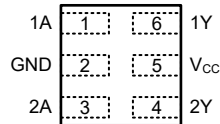

**Figure 5-3. DSF Package
6-Pin SON
Transparent Top View**

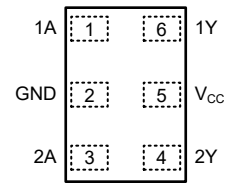

**Figure 5-2. DRY Package
6-Pin SON
Transparent Top View**

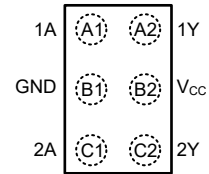

**Figure 5-4. YFP Package
6-Pin DSBGA
Transparent Top View**

See the mechanical drawings for dimensions.

Table 5-1. Pin Functions

NAME	PIN		TYPE ⁽¹⁾	DESCRIPTION
	DCK, DSF, DRY, YFP	(BGA) YFP		
1A	1	A1	I	Input 1
1Y	6	A2	O	Output 1
2A	3	C1	I	Input 2
2Y	4	C2	O	Output 2
GND	2	B1	P	Ground
V _{CC}	5	B2	P	Power Pin

(1) I = Input, O = Output, P = Power

6 Specifications

6.1 Absolute Maximum Ratings

over operating free-air temperature range (unless otherwise noted)

		MIN	MAX	UNIT
V _{CC}	Supply voltage range	-0.5	4.6	V
V _I	Input voltage range ⁽¹⁾	-0.5	4.6	V
V _O	Voltage range applied to any output in the high-impedance or power-off state ⁽¹⁾	-0.5	4.6	V
V _O	Output voltage range in the low state ⁽¹⁾	-0.5	4.6	V
I _{IK}	Input clamp current	V _I < 0		-50 mA
I _{OK}	Output clamp current	V _O < 0		-50 mA
I _O	Continuous output current			±20 mA
	Continuous current through V _{CC} or GND			±50 mA
T _J	Junction temperature			150 °C
T _{stg}	Storage temperature range	-65	150	°C

(1) The input negative-voltage and output voltage ratings may be exceeded if the input and output current ratings are observed.

6.2 ESD Ratings

		VALUE	UNIT
V _(ESD)	Electrostatic discharge	Human-body model (HBM), per ANSI/ESDA/JEDEC JS-001 ⁽¹⁾	±4500
		Charged-device model (CDM), per JEDEC specification JESD22-C101 ⁽²⁾	±1500

(1) JEDEC document JEP155 states that 500-V HBM allows safe manufacturing with a standard ESD control process. Manufacturing with less than 500-V HBM is possible with the necessary precautions.

(2) JEDEC document JEP157 states that 250-V CDM allows safe manufacturing with a standard ESD control process. Manufacturing with less than 250-V CDM is possible with the necessary precautions.

6.3 Recommended Operating Conditions

over operating free-air temperature range (unless otherwise noted)⁽¹⁾

		MIN	MAX	UNIT
V _{CC}	Supply voltage	0.8	3.6	V
V _{IH}	High-level input voltage	V _{CC} = 0.8 V	V _{CC}	V
		V _{CC} = 1.1 V to 1.95 V	0.65 × V _{CC}	
		V _{CC} = 2.3 V to 2.7 V	1.6	
		V _{CC} = 3 V to 3.6 V	2	
V _{IL}	Low-level input voltage	V _{CC} = 0.8 V	0	V
		V _{CC} = 1.1 V to 1.95 V	0.35 × V _{CC}	
		V _{CC} = 2.3 V to 2.7 V	0.7	
		V _{CC} = 3 V to 3.6 V	0.9	
V _I	Input voltage	0	3.6	V
V _O	Output voltage	0	3.6	V
I _{OL}	Low-level output current	V _{CC} = 0.8 V	20	μA
		V _{CC} = 1.1 V	1.1	
		V _{CC} = 1.4 V	1.7	
		V _{CC} = 1.65 V	1.9	
		V _{CC} = 2.3 V	3.1	
		V _{CC} = 3 V	4	
Δt/Δv	Input transition rise or fall rate	V _{CC} = 0.8 V to 3.6 V	200	ns/V
T _A	Operating free-air temperature	–40	85	°C

(1) All unused inputs of the device must be held at V_{CC} or GND to ensure proper device operation. Refer to the TI application report, *Implications of Slow or Floating CMOS Inputs*, literature number [SCBA004](#).

6.4 Thermal Information

THERMAL METRIC ⁽¹⁾	YFP	DCK	DRY	DSF	UNIT	
	6 PINS	6 PINS	6 PINS	6 PINS		
R _{θJA}	Junction-to-ambient thermal resistance	125.4	302.4	338.0	372.5	°C/W
R _{θJC(top)}	Junction-to-case (top) thermal resistance	1.9	219.5	228.9	179.9	°C/W
R _{θJB}	Junction-to-board thermal resistance	37.2	106.7	203.5	231.2	°C/W
Ψ _{JT}	Junction-to-top characterization parameter	0.5	84.2	62.4	28.6	°C/W
Ψ _{JB}	Junction-to-board characterization parameter	37.5	106.0	203.6	230.9	°C/W
R _{θJC(bot)}	Junction-to-case (bottom) thermal resistance	N/A	N/A	N/A	N/A	°C/W

(1) For more information about traditional and new thermal metrics, see the *IC Package Thermal Metrics* application report, [SPRA953](#).

6.5 Electrical Characteristics

over recommended operating free-air temperature range (unless otherwise noted)

PARAMETER	TEST CONDITIONS	V _{CC}	T _A = 25°C			T _A = –40°C to 85°C		UNIT
			MIN	TYP	MAX	MIN	MAX	
V _{OL}	I _{OL} = 20 μA	0.8 V to 3.6 V			0.1		0.1	V
	I _{OL} = 1.1 mA	1.1 V			0.3 × V _{CC}		0.3 × V _{CC}	
	I _{OL} = 1.7 mA	1.4 V			0.31		0.37	
	I _{OL} = 1.9 mA	1.65 V			0.31		0.35	
	I _{OL} = 2.3 mA	2.3 V			0.31		0.33	
	I _{OL} = 3.1 mA				0.44		0.45	
	I _{OL} = 2.7 mA	3 V			0.31		0.33	
	I _{OL} = 4 mA				0.44		0.45	
I _I A or B input	V _I = GND to 3.6 V	0 V to 3.6 V			0.1		0.5	μA
I _{off}	V _I or V _O = 0 V to 3.6 V	0 V			0.2		0.6	μA
ΔI _{off}	V _I or V _O = 0 V to 3.6 V	0 V to 0.2 V			0.2		0.6	μA
I _{CC}	V _I = GND or (V _{CC} to 3.6 V), I _O = 0	0.8 V to 3.6 V			0.5		0.9	μA
ΔI _{CC}	V _I = V _{CC} – 0.6 V ⁽¹⁾ , I _O = 0	3.3 V			40		50	μA
C _i	V _I = V _{CC} or GND	0 V		1.5				pF
		3.6 V		1.5				
C _o	V _O = GND	0 V		3				pF

(1) One input at V_{CC} – 0.6 V, other input at V_{CC} or GND.

6.6 Switching Characteristics, $C_L = 5 \text{ pF}$

over recommended operating free-air temperature range (unless otherwise noted) (see [Figure 7-1](#) and [Figure 7-2](#))

PARAMETER	FROM (INPUT)	TO (OUTPUT)	V_{CC}	$T_A = 25^\circ\text{C}$			$T_A = -40^\circ\text{C}$ to 85°C		UNIT
				MIN	TYP	MAX	MIN	MAX	
t_{pd}	A	Y	0.8 V	12.2					ns
			$1.2 \text{ V} \pm 0.1 \text{ V}$	3.4	5.1	7.5	1.5	14.7	
			$1.5 \text{ V} \pm 0.1 \text{ V}$	2.3	3.6	5.1	1.3	8.3	
			$1.8 \text{ V} \pm 0.15 \text{ V}$	2.4	3.1	4	1	6.3	
			$2.5 \text{ V} \pm 0.2 \text{ V}$	1.5	2.1	2.9	0.9	4.1	
			$3.3 \text{ V} \pm 0.3 \text{ V}$	1.8	2.2	2.8	1.1	3.3	

6.7 Switching Characteristics, $C_L = 10 \text{ pF}$

over recommended operating free-air temperature range (unless otherwise noted) (see [Figure 7-1](#) and [Figure 7-2](#))

PARAMETER	FROM (INPUT)	TO (OUTPUT)	V_{CC}	$T_A = 25^\circ\text{C}$			$T_A = -40^\circ\text{C}$ to 85°C		UNIT
				MIN	TYP	MAX	MIN	MAX	
t_{pd}	A	Y	0.8 V	15					ns
			$1.2 \text{ V} \pm 0.1 \text{ V}$	4	6.2	9	2.4	16.2	
			$1.5 \text{ V} \pm 0.1 \text{ V}$	3.1	4.4	6.1	2	9.4	
			$1.8 \text{ V} \pm 0.15 \text{ V}$	3.3	3.9	4.8	1.6	7.1	
			$2.5 \text{ V} \pm 0.2 \text{ V}$	2.1	2.8	3.5	1.3	4.8	
			$3.3 \text{ V} \pm 0.3 \text{ V}$	2.3	3	4	1.4	4.5	

6.8 Switching Characteristics, $C_L = 15 \text{ pF}$

over recommended operating free-air temperature range (unless otherwise noted) (see [Figure 7-1](#) and [Figure 7-2](#))

PARAMETER	FROM (INPUT)	TO (OUTPUT)	V_{CC}	$T_A = 25^\circ\text{C}$			$T_A = -40^\circ\text{C}$ to 85°C		UNIT
				MIN	TYP	MAX	MIN	MAX	
t_{pd}	A	Y	0.8 V	18.2					ns
			$1.2 \text{ V} \pm 0.1 \text{ V}$	4.9	7.3	10.4	3.2	17.6	
			$1.5 \text{ V} \pm 0.1 \text{ V}$	3.8	5.2	6.8	2.6	10.2	
			$1.8 \text{ V} \pm 0.15 \text{ V}$	3.4	4.8	6.7	2.2	7.9	
			$2.5 \text{ V} \pm 0.2 \text{ V}$	2.4	3.4	4.5	1.9	5.3	
			$3.3 \text{ V} \pm 0.3 \text{ V}$	2.2	3.7	5.4	1.8	6.1	

6.9 Switching Characteristics, $C_L = 30 \text{ pF}$

over recommended operating free-air temperature range (unless otherwise noted) (see [Figure 7-1](#) and [Figure 7-2](#))

PARAMETER	FROM (INPUT)	TO (OUTPUT)	V_{CC}	$T_A = 25^\circ\text{C}$			$T_A = -40^\circ\text{C}$ to 85°C		UNIT
				MIN	TYP	MAX	MIN	MAX	
t_{pd}	A	Y	0.8 V	26.5					ns
			$1.2 \text{ V} \pm 0.1 \text{ V}$	8.1	10.7	14.4	4.5	21.9	
			$1.5 \text{ V} \pm 0.1 \text{ V}$	6.5	7.7	9.4	3.8	13	
			$1.8 \text{ V} \pm 0.15 \text{ V}$	5.8	7.5	9.7	3.2	11	
			$2.5 \text{ V} \pm 0.2 \text{ V}$	4.5	5.4	6.7	3	7.1	
			$3.3 \text{ V} \pm 0.3 \text{ V}$	3.9	6.3	9.7	2.8	10.4	

6.10 Operating Characteristics

T_A = 25°C

PARAMETER		TEST CONDITIONS	V _{CC}	TYP	UNIT
C _{pd}	Power dissipation capacitance	f = 10 MHz	0.8 V	4	pF
			1.2 V ± 0.1 V	4	
			1.5 V ± 0.1 V	4	
			1.8 V ± 0.15 V	4	
			2.5 V ± 0.2 V	4.1	
			3.3 V ± 0.3 V	4.3	

6.11 Typical Characteristics

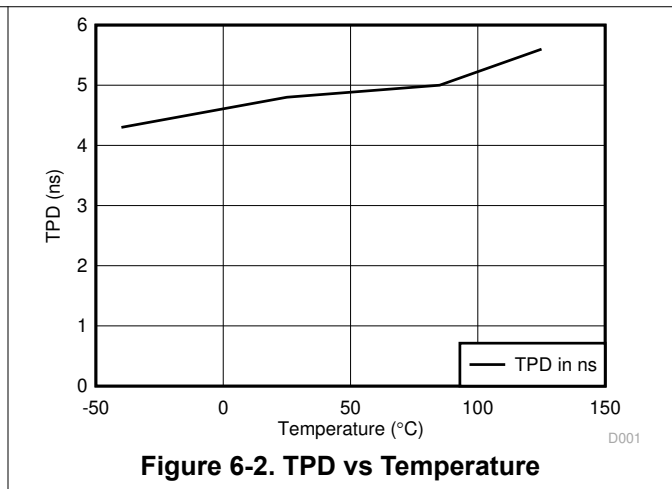
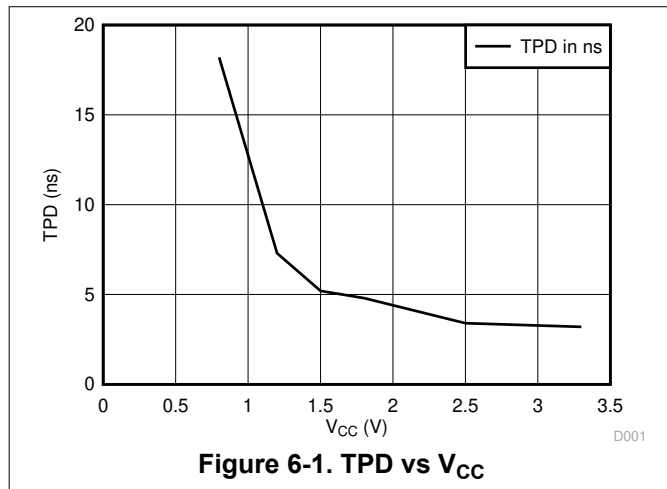

7 Parameter Measurement Information

7.1 Propagation Delays, Setup and Hold Times, and Pulse Duration

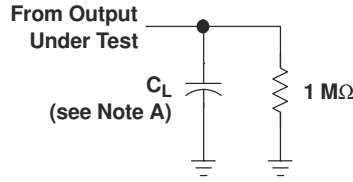

LOAD CIRCUIT

	$V_{CC} = 0.8\text{ V}$	$V_{CC} = 1.2\text{ V} \pm 0.1\text{ V}$	$V_{CC} = 1.5\text{ V} \pm 0.1\text{ V}$	$V_{CC} = 1.8\text{ V} \pm 0.15\text{ V}$	$V_{CC} = 2.5\text{ V} \pm 0.2\text{ V}$	$V_{CC} = 3.3\text{ V} \pm 0.3\text{ V}$
C_L	5, 10, 15, 30 pF	5, 10, 15, 30 pF	5, 10, 15, 30 pF	5, 10, 15, 30 pF	5, 10, 15, 30 pF	5, 10, 15, 30 pF
V_M	$V_{CC}/2$	$V_{CC}/2$	$V_{CC}/2$	$V_{CC}/2$	$V_{CC}/2$	$V_{CC}/2$
V_I	V_{CC}	V_{CC}	V_{CC}	V_{CC}	V_{CC}	V_{CC}

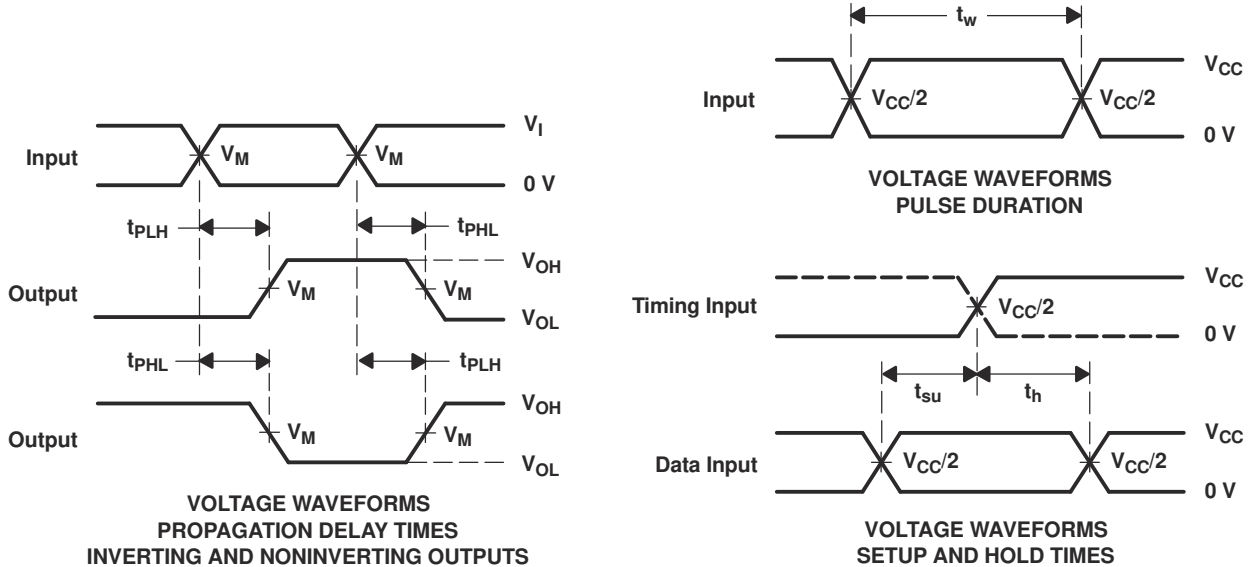

- NOTES:
- A. C_L includes probe and jig capacitance.
 - B. All input pulses are supplied by generators having the following characteristics: $PRR \leq 10\text{ MHz}$, $Z_O = 50\ \Omega$, $t_r/t_f = 3\text{ ns}$.
 - C. The outputs are measured one at a time, with one transition per measurement.
 - D. t_{PLH} and t_{PHL} are the same as t_{pd} .
 - E. All parameters and waveforms are not applicable to all devices.

Figure 7-1. Load Circuit and Voltage Waveforms

7.2 Enable and Disable Times

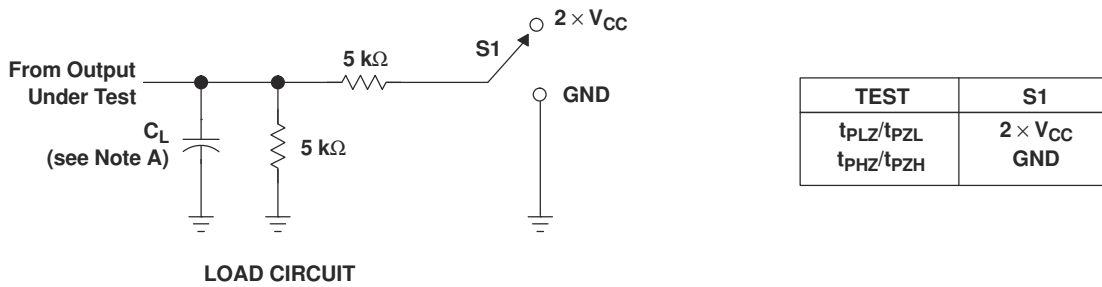

	$V_{CC} = 0.8 \text{ V}$	$V_{CC} = 1.2 \text{ V} \pm 0.1 \text{ V}$	$V_{CC} = 1.5 \text{ V} \pm 0.1 \text{ V}$	$V_{CC} = 1.8 \text{ V} \pm 0.15 \text{ V}$	$V_{CC} = 2.5 \text{ V} \pm 0.2 \text{ V}$	$V_{CC} = 3.3 \text{ V} \pm 0.3 \text{ V}$
C_L	5, 10, 15, 30 pF	5, 10, 15, 30 pF	5, 10, 15, 30 pF	5, 10, 15, 30 pF	5, 10, 15, 30 pF	5, 10, 15, 30 pF
V_M	$V_{CC}/2$	$V_{CC}/2$	$V_{CC}/2$	$V_{CC}/2$	$V_{CC}/2$	$V_{CC}/2$
V_I	V_{CC}	V_{CC}	V_{CC}	V_{CC}	V_{CC}	V_{CC}
V_{Δ}	0.1 V	0.1 V	0.1 V	0.15 V	0.15 V	0.3 V

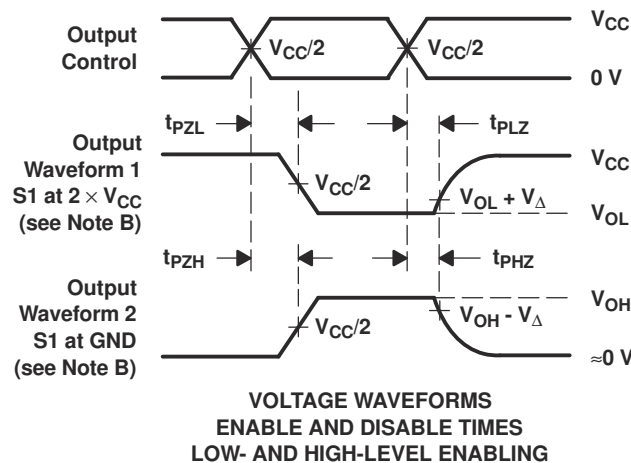

- NOTES:
- A. C_L includes probe and jig capacitance.
 - B. Waveform 1 is for an output with internal conditions such that the output is low, except when disabled by the output control. Waveform 2 is for an output with internal conditions such that the output is high, except when disabled by the output control.
 - C. All input pulses are supplied by generators having the following characteristics: $PRR \leq 10 \text{ MHz}$, $Z_O = 50 \Omega$, $t_r/t_f = 3 \text{ ns}$.
 - D. The outputs are measured one at a time, with one transition per measurement.
 - E. t_{PLZ} and t_{PHZ} are the same as t_{dis} .
 - F. t_{PZL} and t_{PZH} are the same as t_{en} .
 - G. All parameters and waveforms are not applicable to all devices.

Figure 7-2. Load Circuit and Voltage Waveforms

8 Detailed Description

8.1 Overview

The SN74AUP2G07 device is a dual buffer gate with open-drain outputs that operate from 0.8 V to 3.6 V. The output of this dual buffer/driver is open-drain, and can be connected to other open-drain outputs to implement active-low wired-OR or active-high wired-AND functions.

This device is fully specified for partial-power-down applications using I_{off} . The I_{off} circuitry disables the outputs, preventing damaging current backflow through the device when it is powered down. The I_{off} feature also allows for live insertion.

8.2 Functional Block Diagram

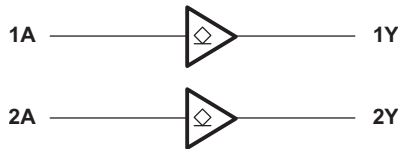

8.3 Feature Description

- Wide operating V_{CC} range of 0.8 V to 3.6 V
- 3.6-V I/O tolerant to support down translation
- Input hysteresis allows slow input transition and better switching noise immunity at the input
- I_{off} feature allows voltages on the inputs and outputs when V_{CC} is 0 V
- Low noise due to slower edge rates

8.4 Device Functional Modes

Table 8-1 is the function table for SN74AUP2G07.

Table 8-1. Function Table

INPUT ⁽¹⁾ A	OUTPUT ⁽²⁾ Y
H	Z
L	L

(1) L = Input low, H = Input high

(2) L = Output low, Z = High impedance

9 Application and Implementation

Note

Information in the following applications sections is not part of the TI component specification, and TI does not warrant its accuracy or completeness. TI's customers are responsible for determining suitability of components for their purposes, as well as validating and testing their design implementation to confirm system functionality.

9.1 Application Information

The AUP family is TI's premier solution to the industry's low-power needs in battery-powered portable applications. This family ensures very low static and dynamic power consumption across the entire V_{CC} range of 0.8 V to 3.6 V, resulting in increased battery life. This product also maintains excellent signal integrity. It has a small amount of hysteresis built in, allowing for slower or noisy input signals. The lowered drive produces slower edges and prevents overshoot and undershoot on the outputs.

9.2 Typical Application

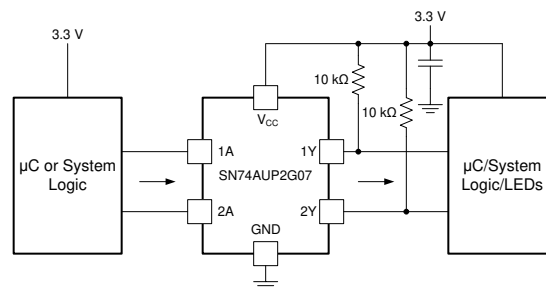

Figure 9-1. Typical Application Schematic

9.2.1 Design Requirements

This device uses CMOS technology and has balanced output drive. Care should be taken to avoid bus contention because it can drive currents that would exceed maximum limits.

9.2.2 Detailed Design Procedure

- Recommended Input Conditions:
 - For rise time and fall time specifications, see $\Delta t/\Delta V$ in the [Section 6.3](#) table.
 - For specified high and low levels. See V_{IH} and V_{IL} in the [Section 6.3](#) table.
 - Inputs are overvoltage tolerant allowing them to go as high as 3.6 V at any valid V_{CC} .
- Recommend Output Conditions:
 - Load currents should not exceed 20 mA on the output and 50 mA total for the part.

9.2.3 Application Curves

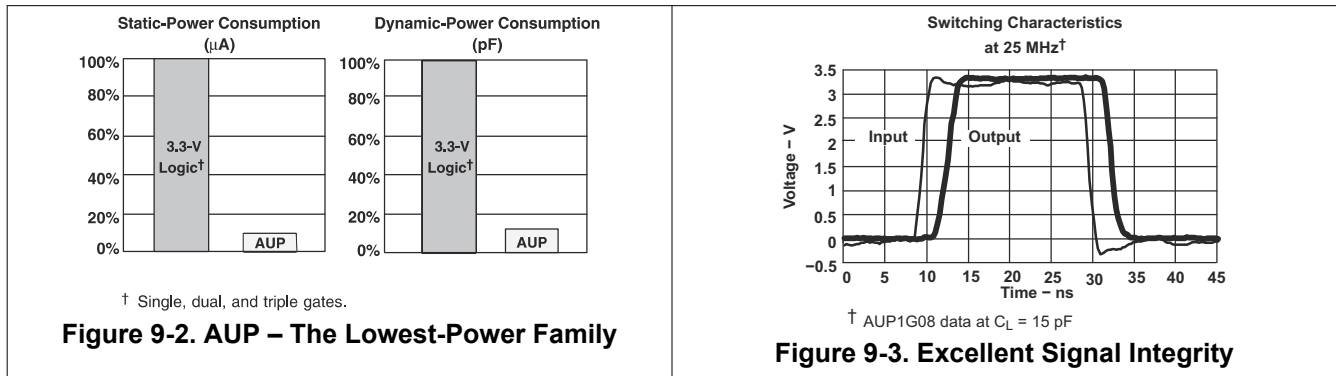

The AUP family of single gate logic makes excellent translators for the new lower voltage microprocessors that typically are powered from 0.8 V to 1.2 V. They can drop the voltage of peripheral drivers and accessories that are still powered by 3.3 V to the new uC power levels.

10 Power Supply Recommendations

The power supply can be any voltage between the Min and Max supply voltage rating located in the [Section 6.3](#) table.

Each V_{CC} pin should have a good bypass capacitor to prevent power disturbance. For devices with a single supply, 0.1 μF is recommended; if there are multiple V_{CC} pins, then 0.01 μF or 0.022 μF is recommended for each power pin. It is acceptable to parallel multiple bypass capacitors to reject different frequencies of noise. A 0.1 μF and a 1 μF are commonly used in parallel. The bypass capacitor should be installed as close to the power pin as possible for best results.

11 Layout

11.1 Layout Guidelines

In many cases, functions or parts of functions of digital logic devices are unused, for example, when only two inputs of a triple-input AND gate are used, or when only 3 of the 4 buffer gates are used.

Such input pins should not be left unconnected because the undefined voltages at the outside connections result in undefined operational states. [Figure 11-1](#) specifies the rules that must be observed under all circumstances. All unused inputs of digital logic devices must be connected to a high or low bias to prevent them from floating. The logic level that should be applied to any particular unused input depends on the function of the device. Generally they will be tied to GND or V_{CC} , whichever makes more sense or is more convenient. It is acceptable to float outputs, unless the part is a transceiver. If the transceiver has an output enable pin, it will disable the output section of the part when asserted. This will not disable the input section of the I/Os, so they cannot float when disabled.

11.2 Layout Example

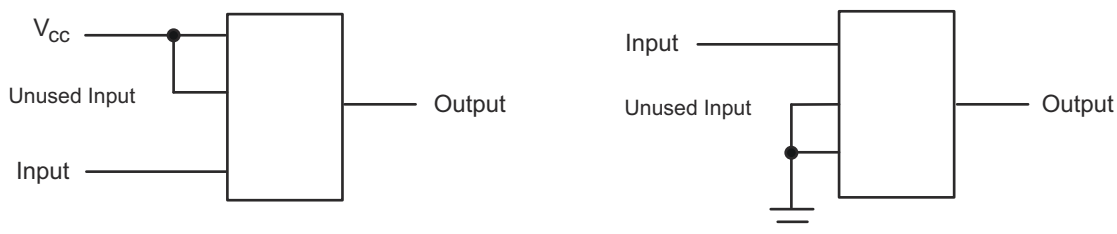

Figure 11-1. Layout Diagram

12 Device and Documentation Support

12.1 Receiving Notification of Documentation Updates

To receive notification of documentation updates, navigate to the device product folder on ti.com. Click on *Subscribe to updates* to register and receive a weekly digest of any product information that has changed. For change details, review the revision history included in any revised document.

12.2 Support Resources

TI E2E™ [support forums](#) are an engineer's go-to source for fast, verified answers and design help — straight from the experts. Search existing answers or ask your own question to get the quick design help you need.

Linked content is provided "AS IS" by the respective contributors. They do not constitute TI specifications and do not necessarily reflect TI's views; see TI's [Terms of Use](#).

12.3 Trademarks

TI E2E™ is a trademark of Texas Instruments.

All trademarks are the property of their respective owners.

12.4 Electrostatic Discharge Caution



This integrated circuit can be damaged by ESD. Texas Instruments recommends that all integrated circuits be handled with appropriate precautions. Failure to observe proper handling and installation procedures can cause damage.

ESD damage can range from subtle performance degradation to complete device failure. Precision integrated circuits may be more susceptible to damage because very small parametric changes could cause the device not to meet its published specifications.

12.5 Glossary

[TI Glossary](#) This glossary lists and explains terms, acronyms, and definitions.

13 Mechanical, Packaging, and Orderable Information

The following pages include mechanical, packaging, and orderable information. This information is the most current data available for the designated devices. This data is subject to change without notice and revision of this document. For browser-based versions of this data sheet, refer to the left-hand navigation.

PACKAGING INFORMATION

Orderable Device	Status (1)	Package Type	Package Drawing	Pins	Package Qty	Eco Plan (2)	Lead finish/ Ball material (6)	MSL Peak Temp (3)	Op Temp (°C)	Device Marking (4/5)	Samples
SN74AUP2G07DCKR	ACTIVE	SC70	DCK	6	3000	RoHS & Green	NIPDAU	Level-1-260C-UNLIM	-40 to 85	(H55, H5F)	Samples
SN74AUP2G07DRYR	ACTIVE	SON	DRY	6	5000	RoHS & Green	NIPDAU NIPDAUAG	Level-1-260C-UNLIM	-40 to 85	H5	Samples
SN74AUP2G07DSFR	ACTIVE	SON	DSF	6	5000	RoHS & Green	NIPDAU NIPDAUAG	Level-1-260C-UNLIM	-40 to 85	H5	Samples
SN74AUP2G07YFPR	ACTIVE	DSBGA	YFP	6	3000	RoHS & Green	SNAGCU	Level-1-260C-UNLIM	-40 to 85	HVN	Samples

(1) The marketing status values are defined as follows:

ACTIVE: Product device recommended for new designs.

LIFEBUY: TI has announced that the device will be discontinued, and a lifetime-buy period is in effect.

NRND: Not recommended for new designs. Device is in production to support existing customers, but TI does not recommend using this part in a new design.

PREVIEW: Device has been announced but is not in production. Samples may or may not be available.

OBSELETE: TI has discontinued the production of the device.

(2) **RoHS:** TI defines "RoHS" to mean semiconductor products that are compliant with the current EU RoHS requirements for all 10 RoHS substances, including the requirement that RoHS substance do not exceed 0.1% by weight in homogeneous materials. Where designed to be soldered at high temperatures, "RoHS" products are suitable for use in specified lead-free processes. TI may reference these types of products as "Pb-Free".

RoHS Exempt: TI defines "RoHS Exempt" to mean products that contain lead but are compliant with EU RoHS pursuant to a specific EU RoHS exemption.

Green: TI defines "Green" to mean the content of Chlorine (Cl) and Bromine (Br) based flame retardants meet JS709B low halogen requirements of <=1000ppm threshold. Antimony trioxide based flame retardants must also meet the <=1000ppm threshold requirement.

(3) MSL, Peak Temp. - The Moisture Sensitivity Level rating according to the JEDEC industry standard classifications, and peak solder temperature.

(4) There may be additional marking, which relates to the logo, the lot trace code information, or the environmental category on the device.

(5) Multiple Device Markings will be inside parentheses. Only one Device Marking contained in parentheses and separated by a "-" will appear on a device. If a line is indented then it is a continuation of the previous line and the two combined represent the entire Device Marking for that device.

(6) Lead finish/Ball material - Orderable Devices may have multiple material finish options. Finish options are separated by a vertical ruled line. Lead finish/Ball material values may wrap to two lines if the finish value exceeds the maximum column width.

Important Information and Disclaimer:The information provided on this page represents TI's knowledge and belief as of the date that it is provided. TI bases its knowledge and belief on information provided by third parties, and makes no representation or warranty as to the accuracy of such information. Efforts are underway to better integrate information from third parties. TI has taken and

continues to take reasonable steps to provide representative and accurate information but may not have conducted destructive testing or chemical analysis on incoming materials and chemicals. TI and TI suppliers consider certain information to be proprietary, and thus CAS numbers and other limited information may not be available for release.

In no event shall TI's liability arising out of such information exceed the total purchase price of the TI part(s) at issue in this document sold by TI to Customer on an annual basis.

TAPE AND REEL INFORMATION

QUADRANT ASSIGNMENTS FOR PIN 1 ORIENTATION IN TAPE

*All dimensions are nominal

Device	Package Type	Package Drawing	Pins	SPQ	Reel Diameter (mm)	Reel Width W1 (mm)	A0 (mm)	B0 (mm)	K0 (mm)	P1 (mm)	W (mm)	Pin1 Quadrant
SN74AUP2G07DCKR	SC70	DCK	6	3000	178.0	9.0	2.4	2.5	1.2	4.0	8.0	Q3
SN74AUP2G07DCKR	SC70	DCK	6	3000	178.0	9.2	2.4	2.4	1.22	4.0	8.0	Q3
SN74AUP2G07DRYR	SON	DRY	6	5000	180.0	8.4	1.25	1.6	0.7	4.0	8.0	Q1
SN74AUP2G07DRYR	SON	DRY	6	5000	180.0	9.5	1.15	1.6	0.75	4.0	8.0	Q1
SN74AUP2G07DSFR	SON	DSF	6	5000	180.0	9.5	1.16	1.16	0.5	4.0	8.0	Q2
SN74AUP2G07YFPR	DSBGA	YFP	6	3000	178.0	9.2	0.89	1.29	0.62	4.0	8.0	Q1

TAPE AND REEL BOX DIMENSIONS

*All dimensions are nominal

Device	Package Type	Package Drawing	Pins	SPQ	Length (mm)	Width (mm)	Height (mm)
SN74AUP2G07DCKR	SC70	DCK	6	3000	180.0	180.0	18.0
SN74AUP2G07DCKR	SC70	DCK	6	3000	180.0	180.0	18.0
SN74AUP2G07DRYR	SON	DRY	6	5000	202.0	201.0	28.0
SN74AUP2G07DRYR	SON	DRY	6	5000	184.0	184.0	19.0
SN74AUP2G07DSFR	SON	DSF	6	5000	184.0	184.0	19.0
SN74AUP2G07YFPR	DSBGA	YFP	6	3000	220.0	220.0	35.0

GENERIC PACKAGE VIEW

DRY 6

USON - 0.6 mm max height

PLASTIC SMALL OUTLINE - NO LEAD



Images above are just a representation of the package family, actual package may vary.
Refer to the product data sheet for package details.

4207181/G

DRY0006A



PACKAGE OUTLINE

USON - 0.6 mm max height

PLASTIC SMALL OUTLINE - NO LEAD

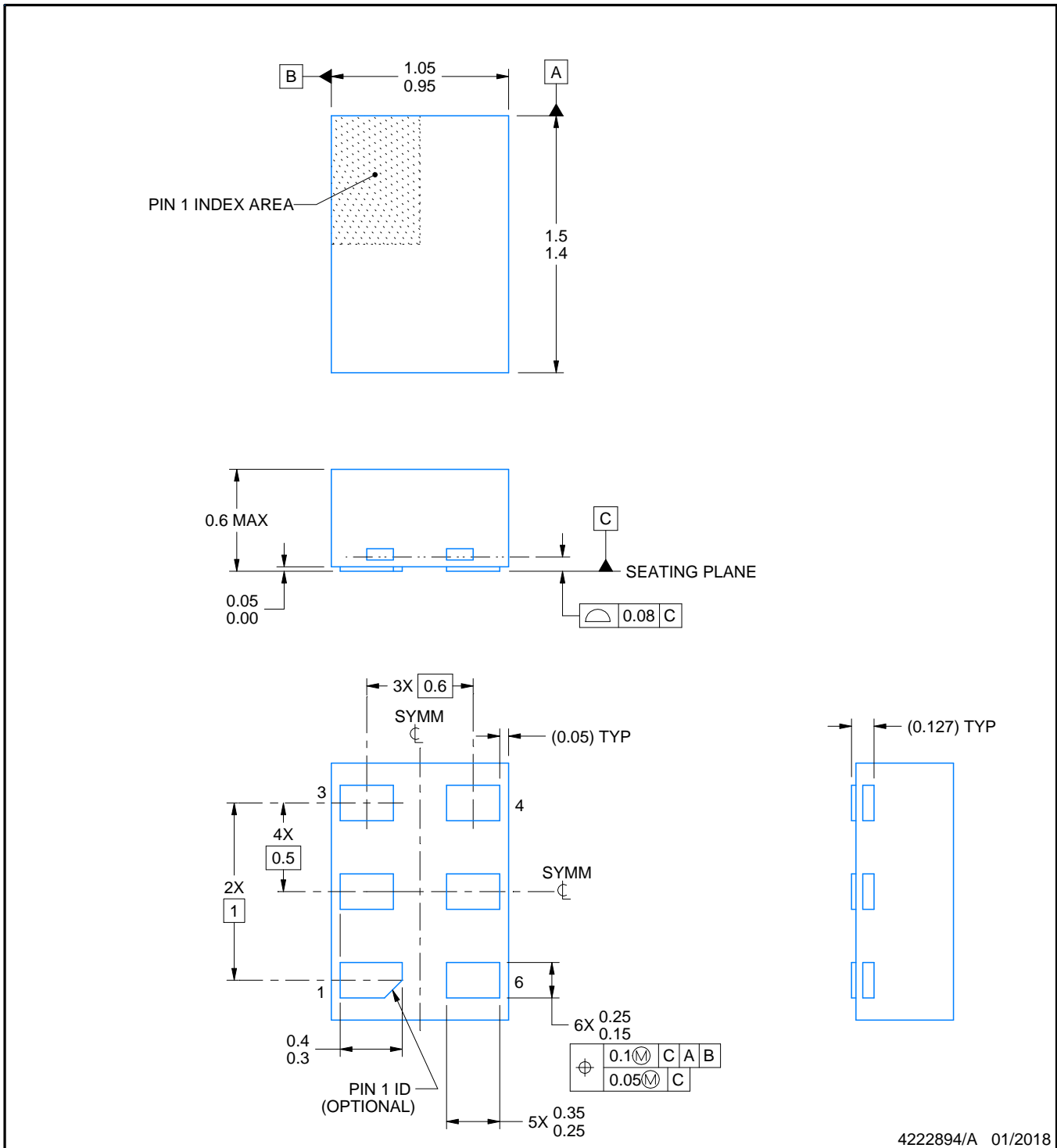

NOTES:

1. All linear dimensions are in millimeters. Any dimensions in parenthesis are for reference only. Dimensioning and tolerancing per ASME Y14.5M.
2. This drawing is subject to change without notice.

EXAMPLE BOARD LAYOUT

DRY0006A

USON - 0.6 mm max height

PLASTIC SMALL OUTLINE - NO LEAD



LAND PATTERN EXAMPLE
1:1 RATIO WITH PKG SOLDER PADS
EXPOSED METAL SHOWN
SCALE:40X



SOLDER MASK DETAILS

4222894/A 01/2018

NOTES: (continued)

3. For more information, see QFN/SON PCB application report in literature No. SLUA271 (www.ti.com/lit/slua271).

EXAMPLE STENCIL DESIGN

DRY0006A

USON - 0.6 mm max height

PLASTIC SMALL OUTLINE - NO LEAD



SOLDER PASTE EXAMPLE
BASED ON 0.075 - 0.1 mm THICK STENCIL
SCALE:40X

4222894/A 01/2018

NOTES: (continued)

4. Laser cutting apertures with trapezoidal walls and rounded corners may offer better paste release. IPC-7525 may have alternate design recommendations.

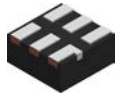

DSF0006A

PACKAGE OUTLINE

X2SON - 0.4 mm max height

PLASTIC SMALL OUTLINE - NO LEAD

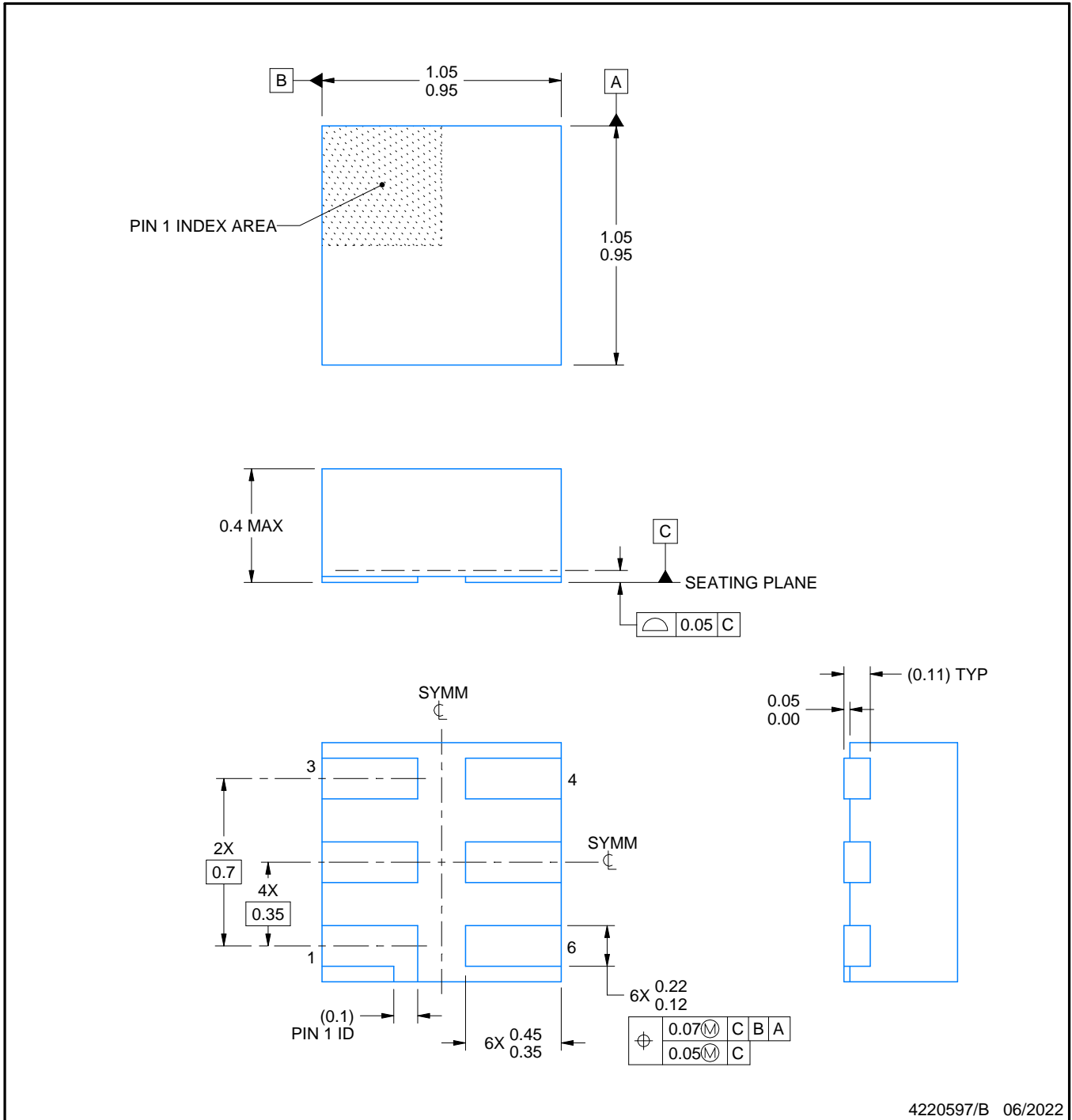

4220597/B 06/2022

NOTES:

1. All linear dimensions are in millimeters. Any dimensions in parenthesis are for reference only. Dimensioning and tolerancing per ASME Y14.5M.
2. This drawing is subject to change without notice.
3. Reference JEDEC registration MO-287, variation X2AAF.

EXAMPLE BOARD LAYOUT

DSF0006A

X2SON - 0.4 mm max height

PLASTIC SMALL OUTLINE - NO LEAD

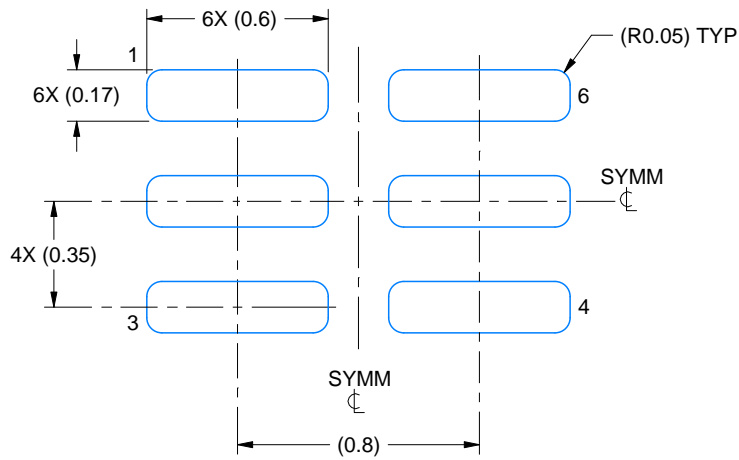

LAND PATTERN EXAMPLE
EXPOSED METAL SHOWN
SCALE:40X



SOLDER MASK DETAILS

4220597/B 06/2022

NOTES: (continued)

4. For more information, see Texas Instruments literature number SLUA271 (www.ti.com/lit/slua271).

EXAMPLE STENCIL DESIGN

DSF0006A

X2SON - 0.4 mm max height

PLASTIC SMALL OUTLINE - NO LEAD



SOLDER PASTE EXAMPLE
BASED ON 0.09 mm THICK STENCIL

PRINTED SOLDER COVERAGE BY AREA UNDER PACKAGE
SCALE:40X

4220597/B 06/2022

4. Laser cutting apertures with trapezoidal walls and rounded corners may offer better paste release. IPC-7525 may have alternate design recommendations.

DCK (R-PDSO-G6)

PLASTIC SMALL-OUTLINE PACKAGE



- NOTES:
- A. All linear dimensions are in millimeters.
 - B. This drawing is subject to change without notice.
 - C. Body dimensions do not include mold flash or protrusion. Mold flash and protrusion shall not exceed 0.15 per side.
 - D. Falls within JEDEC MO-203 variation AB.

DCK (R-PDSO-G6)

PLASTIC SMALL OUTLINE



- NOTES:
- All linear dimensions are in millimeters.
 - This drawing is subject to change without notice.
 - Customers should place a note on the circuit board fabrication drawing not to alter the center solder mask defined pad.
 - Publication IPC-7351 is recommended for alternate designs.
 - Laser cutting apertures with trapezoidal walls and also rounding corners will offer better paste release. Customers should contact their board assembly site for stencil design recommendations. Example stencil design based on a 50% volumetric metal load solder paste. Refer to IPC-7525 for other stencil recommendations.

YFP0006

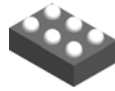

PACKAGE OUTLINE

DSBGA - 0.5 mm max height

DIE SIZE BALL GRID ARRAY

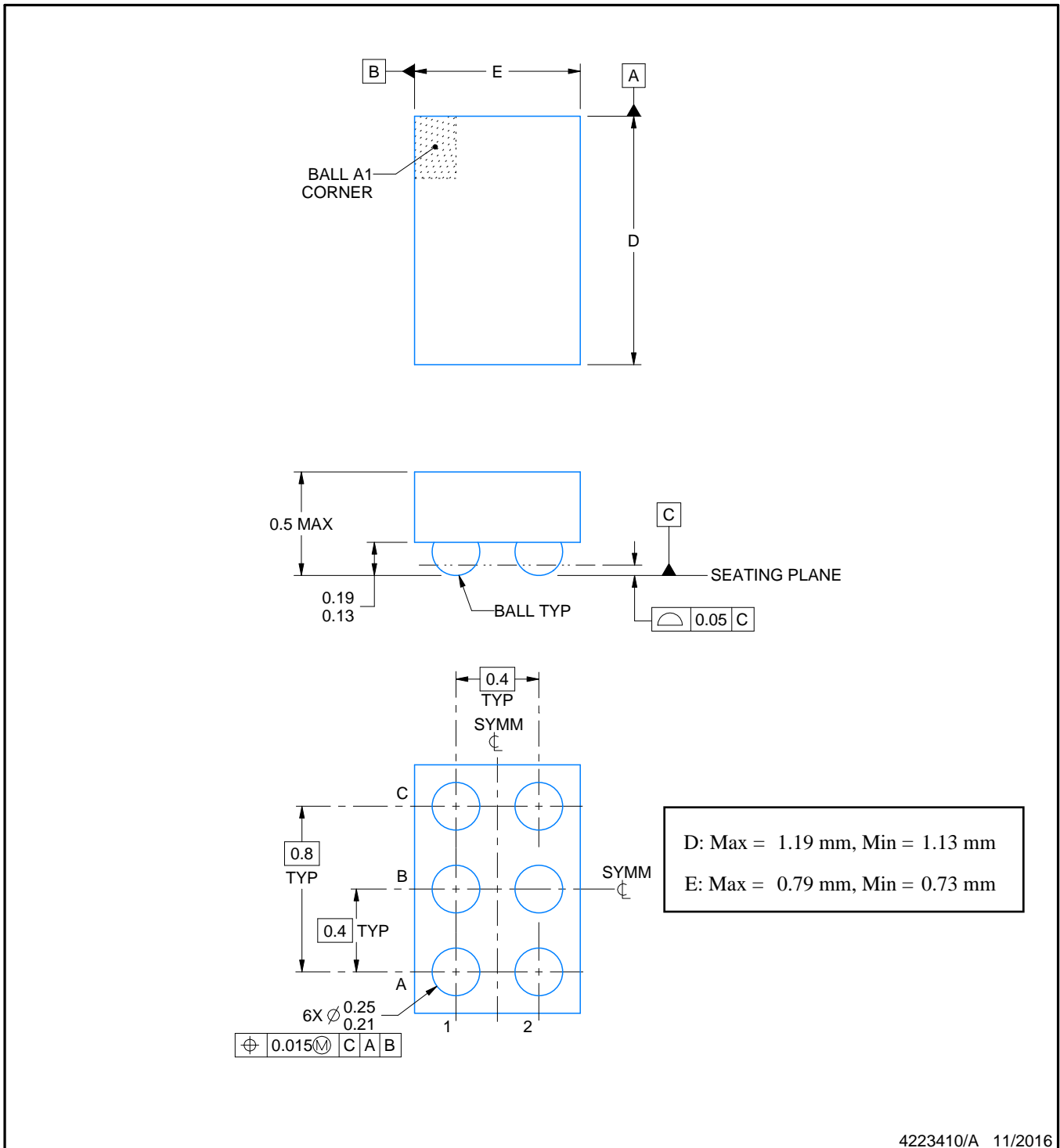

4223410/A 11/2016

NOTES:

1. All linear dimensions are in millimeters. Any dimensions in parenthesis are for reference only. Dimensioning and tolerancing per ASME Y14.5M.
2. This drawing is subject to change without notice.

EXAMPLE BOARD LAYOUT

YFP0006

DSBGA - 0.5 mm max height

DIE SIZE BALL GRID ARRAY

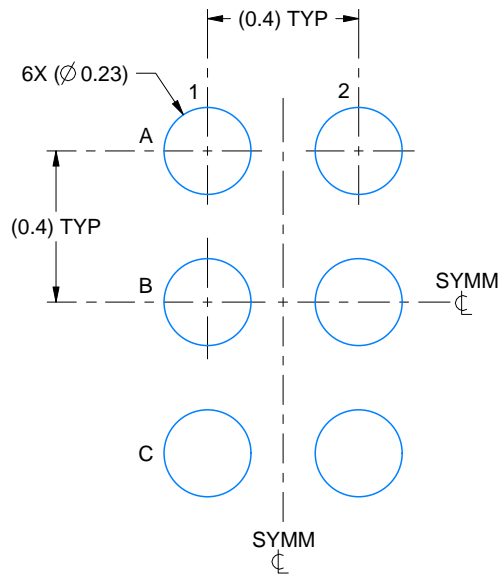

LAND PATTERN EXAMPLE
SCALE:50X

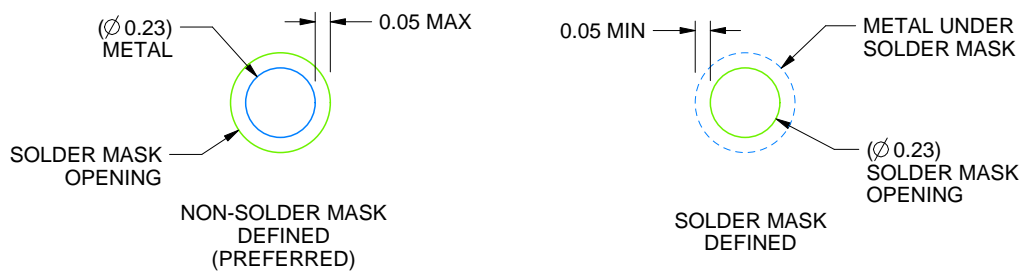

SOLDER MASK DETAILS
NOT TO SCALE

4223410/A 11/2016

NOTES: (continued)

- Final dimensions may vary due to manufacturing tolerance considerations and also routing constraints. For more information, see Texas Instruments literature number SNVA009 (www.ti.com/lit/snva009).

EXAMPLE STENCIL DESIGN

YFP0006

DSBGA - 0.5 mm max height

DIE SIZE BALL GRID ARRAY

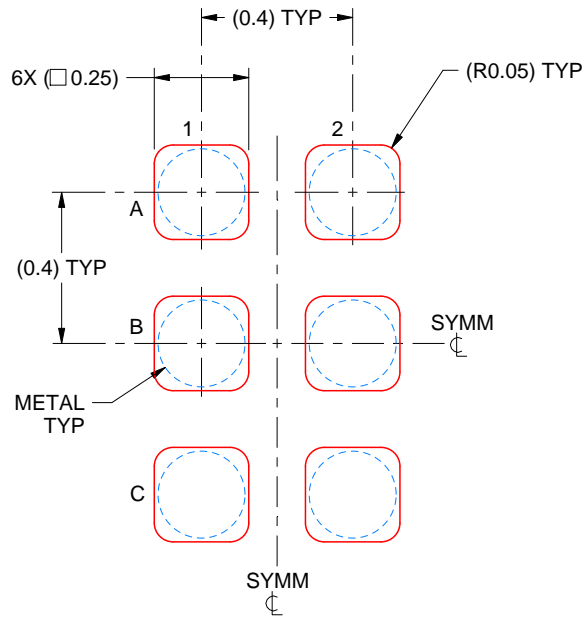

SOLDER PASTE EXAMPLE
BASED ON 0.1 mm THICK STENCIL
SCALE:50X

4223410/A 11/2016

NOTES: (continued)

4. Laser cutting apertures with trapezoidal walls and rounded corners may offer better paste release.

IMPORTANT NOTICE AND DISCLAIMER

TI PROVIDES TECHNICAL AND RELIABILITY DATA (INCLUDING DATA SHEETS), DESIGN RESOURCES (INCLUDING REFERENCE DESIGNS), APPLICATION OR OTHER DESIGN ADVICE, WEB TOOLS, SAFETY INFORMATION, AND OTHER RESOURCES "AS IS" AND WITH ALL FAULTS, AND DISCLAIMS ALL WARRANTIES, EXPRESS AND IMPLIED, INCLUDING WITHOUT LIMITATION ANY IMPLIED WARRANTIES OF MERCHANTABILITY, FITNESS FOR A PARTICULAR PURPOSE OR NON-INFRINGEMENT OF THIRD PARTY INTELLECTUAL PROPERTY RIGHTS.

These resources are intended for skilled developers designing with TI products. You are solely responsible for (1) selecting the appropriate TI products for your application, (2) designing, validating and testing your application, and (3) ensuring your application meets applicable standards, and any other safety, security, regulatory or other requirements.

These resources are subject to change without notice. TI grants you permission to use these resources only for development of an application that uses the TI products described in the resource. Other reproduction and display of these resources is prohibited. No license is granted to any other TI intellectual property right or to any third party intellectual property right. TI disclaims responsibility for, and you will fully indemnify TI and its representatives against, any claims, damages, costs, losses, and liabilities arising out of your use of these resources.

TI's products are provided subject to [TI's Terms of Sale](#) or other applicable terms available either on ti.com or provided in conjunction with such TI products. TI's provision of these resources does not expand or otherwise alter TI's applicable warranties or warranty disclaimers for TI products.

TI objects to and rejects any additional or different terms you may have proposed.

Mailing Address: Texas Instruments, Post Office Box 655303, Dallas, Texas 75265
Copyright © 2022, Texas Instruments Incorporated