

SN74LS14

Schmitt Triggers Dual Gate/Hex Inverter

The SN74LS14 contains logic gates/inverters which accept standard TTL input signals and provide standard TTL output levels. They are capable of transforming slowly changing input signals into sharply defined, jitter-free output signals. Additionally, they have greater noise margin than conventional inverters.

Each circuit contains a Schmitt trigger followed by a Darlington level shifter and a phase splitter driving a TTL totem pole output. The Schmitt trigger uses positive feedback to effectively speed-up slow input transitions, and provide different input threshold voltages for positive and negative-going transitions. This hysteresis between the positive-going and negative-going input thresholds (typically 800 mV) is determined internally by resistor ratios and is essentially insensitive to temperature and supply voltage variations.

LOGIC AND CONNECTION DIAGRAMS

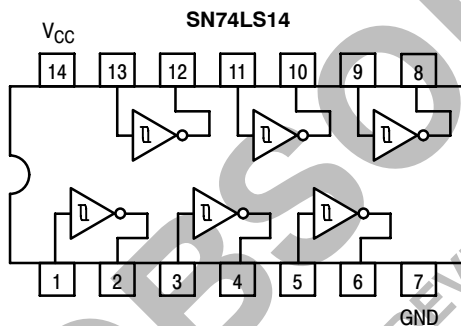

GUARANTEED OPERATING RANGES

Symbol	Parameter	Min	Typ	Max	Unit
V_{CC}	Supply Voltage	4.75	5.0	5.25	V
T_A	Operating Ambient Temperature Range	0	25	70	°C
I_{OH}	Output Current – High			-0.4	mA
I_{OL}	Output Current – Low			8.0	mA



ON Semiconductor™

<http://onsemi.com>

**LOW
POWER
SCHOTTKY**

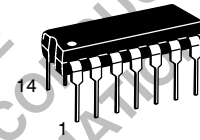

PLASTIC
N SUFFIX
CASE 646

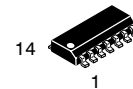

SOIC
D SUFFIX
CASE 751A

ORDERING INFORMATION

Device	Package	Shipping
SN74LS14N	14 Pin DIP	2000 Units/Box
SN74LS14D	SOIC-14	55 Units/Rail
SN74LS14DR2	SOIC-14	2500/Tape & Reel

SN74LS14

DC CHARACTERISTICS OVER OPERATING TEMPERATURE RANGE (unless otherwise specified)

Symbol	Parameter	Limits			Unit	Test Conditions
		Min	Typ	Max		
V_{T+}	Positive-Going Threshold Voltage	1.5		2.0	V	$V_{CC} = 5.0\text{ V}$
V_{T-}	Negative-Going Threshold Voltage	0.6		1.1	V	$V_{CC} = 5.0\text{ V}$
$V_{T+} - V_{T-}$	Hysteresis	0.4	0.8		V	$V_{CC} = 5.0\text{ V}$
V_{IK}	Input Clamp Diode Voltage		-0.65	-1.5	V	$V_{CC} = \text{MIN}$, $I_{IN} = -18\text{ mA}$
V_{OH}	Output HIGH Voltage	2.7	3.4		V	$V_{CC} = \text{MIN}$, $I_{OH} = -400\text{ }\mu\text{A}$, $V_{IN} = V_{IL}$
V_{OL}	Output LOW Voltage		0.25	0.4	V	$V_{CC} = \text{MIN}$, $I_{OL} = 4.0\text{ mA}$, $V_{IN} = 2.0\text{ V}$
			0.35	0.5	V	$V_{CC} = \text{MIN}$, $I_{OL} = 8.0\text{ mA}$, $V_{IN} = 2.0\text{ V}$
I_{T+}	Input Current at Positive-Going Threshold		-0.14		mA	$V_{CC} = 5.0\text{ V}$, $V_{IN} = V_{T+}$
I_{T-}	Input Current at Negative-Going Threshold		-0.18		mA	$V_{CC} = 5.0\text{ V}$, $V_{IN} = V_{T-}$
I_{IH}	Input HIGH Current		1.0	20	μA	$V_{CC} = \text{MAX}$, $V_{IN} = 2.7\text{ V}$
				0.1	mA	$V_{CC} = \text{MAX}$, $V_{IN} = 7.0\text{ V}$
I_{IL}	Input LOW Current			-0.4	mA	$V_{CC} = \text{MAX}$, $V_{IN} = 0.4\text{ V}$
I_{OS}	Short Circuit Current (Note 1)	-20		-100	mA	$V_{CC} = \text{MAX}$, $V_{OUT} = 0\text{ V}$
I_{CC}	Power Supply Current		8.6	16	mA	$V_{CC} = \text{MAX}$
	Total, Output HIGH					
	Total, Output LOW		12	21		

Note 1: Not more than one output should be shorted at a time, nor for more than 1 second.

AC CHARACTERISTICS ($T_A = 25^\circ\text{C}$)

Symbol	Parameter	Max	Unit	Test Conditions
t_{PLH}	Propagation Delay, Input to Output	22	ns	$V_{CC} = 5.0\text{ V}$ $C_L = 15\text{ pF}$
t_{PHL}	Propagation Delay, Input to Output	22	ns	

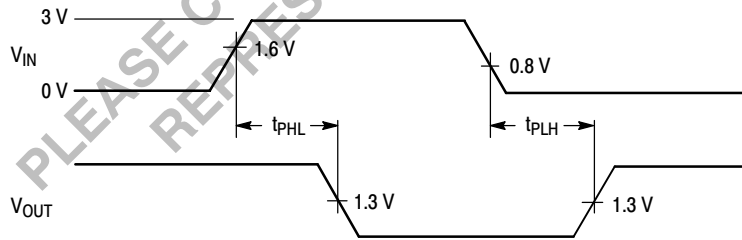

Figure 1. AC Waveforms

SN74LS14

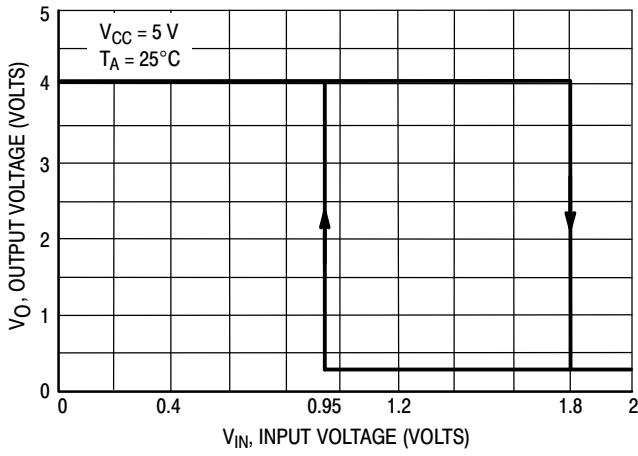

Figure 2. V_{IN} versus V_{OUT} Transfer Function

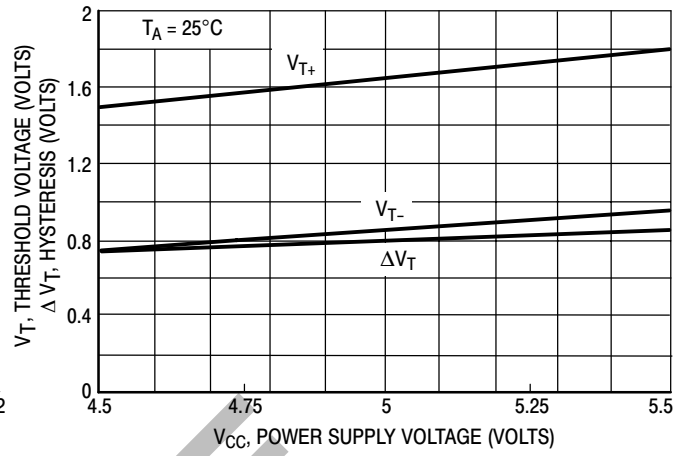

Figure 3. Threshold Voltage and Hysteresis versus Power Supply Voltage

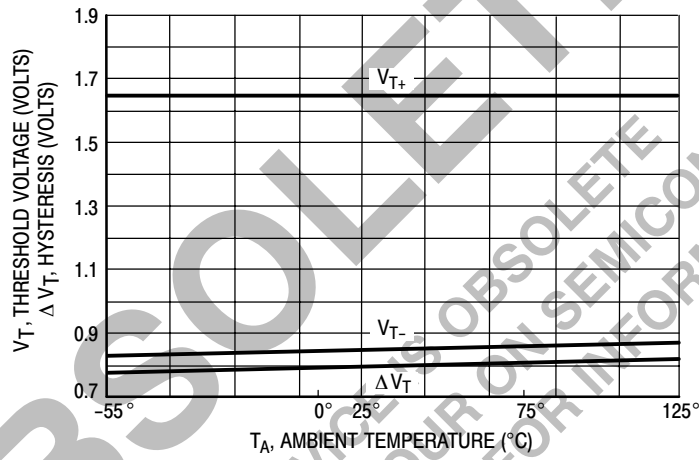
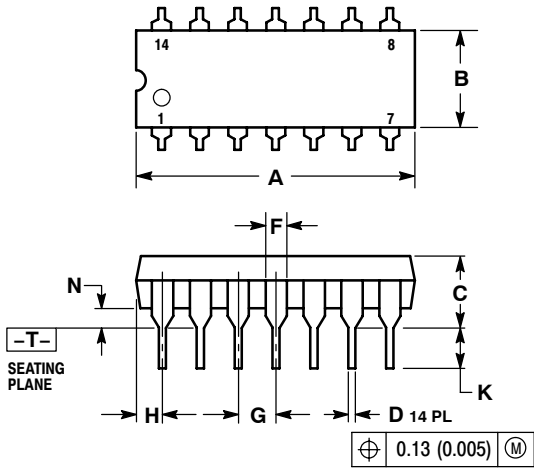

Figure 4. Threshold Voltage Hysteresis versus Temperature

SN74LS14

PACKAGE DIMENSIONS

N SUFFIX
PLASTIC PACKAGE
CASE 646-06
ISSUE M



NOTES:

1. DIMENSIONING AND TOLERANCING PER ANSI Y14.5M, 1982.
2. CONTROLLING DIMENSION: INCH.
3. DIMENSION L TO CENTER OF LEADS WHEN FORMED PARALLEL.
4. DIMENSION B DOES NOT INCLUDE MOLD FLASH.
5. ROUNDED CORNERS OPTIONAL.

DIM	INCHES		MILLIMETERS	
	MIN	MAX	MIN	MAX
A	0.715	0.770	18.16	18.80
B	0.240	0.260	6.10	6.60
C	0.145	0.185	3.69	4.69
D	0.015	0.021	0.38	0.53
F	0.040	0.070	1.02	1.78
G	0.100 BSC		2.54 BSC	
H	0.052	0.095	1.32	2.41
J	0.008	0.015	0.20	0.38
K	0.115	0.135	2.92	3.43
L	0.290	0.310	7.37	7.87
M	---	10°	---	10°
N	0.015	0.039	0.38	1.01

OBSOLETE

THIS DEVICE IS OBSOLETE
 PLEASE CONTACT YOUR ON SEMICONDUCTOR REPRESENTATIVE FOR INFORMATION

SN74LS14

PACKAGE DIMENSIONS

D SUFFIX PLASTIC SOIC PACKAGE CASE 751A-03 ISSUE F

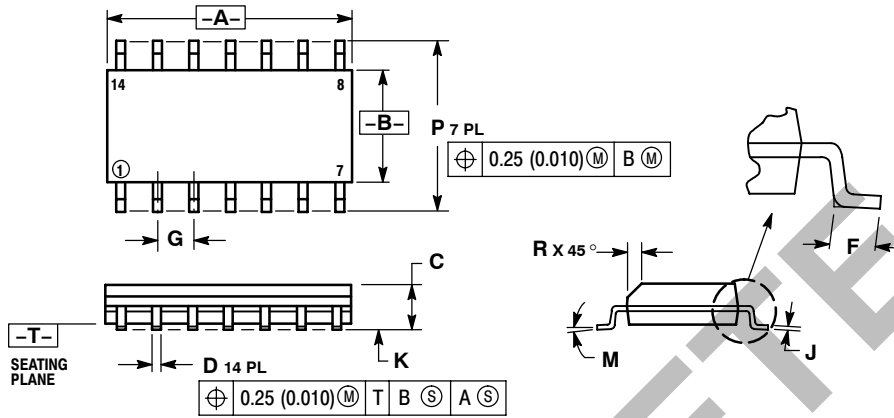

NOTES:

1. DIMENSIONING AND TOLERANCING PER ANSI Y14.5M, 1982.
2. CONTROLLING DIMENSION: MILLIMETER.
3. DIMENSIONS A AND B DO NOT INCLUDE MOLD PROTRUSION.
4. MAXIMUM MOLD PROTRUSION 0.15 (0.006) PER SIDE.
5. DIMENSION D DOES NOT INCLUDE DAMBAR PROTRUSION. ALLOWABLE DAMBAR PROTRUSION SHALL BE 0.127 (0.005) TOTAL IN EXCESS OF THE D DIMENSION AT MAXIMUM MATERIAL CONDITION.

DIM	MILLIMETERS		INCHES	
	MIN	MAX	MIN	MAX
A	8.55	8.75	0.337	0.344
B	3.80	4.00	0.150	0.157
C	1.35	1.75	0.054	0.068
D	0.35	0.49	0.014	0.019
F	0.40	1.25	0.016	0.049
G	1.27 BSC		0.050 BSC	
J	0.19	0.25	0.008	0.009
K	0.10	0.25	0.004	0.009
M	0°	7°	0°	7°
P	5.80	6.20	0.228	0.244
R	0.25	0.50	0.010	0.019

ON Semiconductor and are registered trademarks of Semiconductor Components Industries, LLC (SCILLC). SCILLC reserves the right to make changes without further notice to any products herein. SCILLC makes no warranty, representation or guarantee regarding the suitability of its products for any particular purpose, nor does SCILLC assume any liability arising out of the application or use of any product or circuit, and specifically disclaims any and all liability, including without limitation special, consequential or incidental damages. "Typical" parameters which may be provided in SCILLC data sheets and/or specifications can and do vary in different applications and actual performance may vary over time. All operating parameters, including "Typicals" must be validated for each customer application by customer's technical experts. SCILLC does not convey any license under its patent rights nor the rights of others. SCILLC products are not designed, intended, or authorized for use as components in systems intended for surgical implant into the body, or other applications intended to support or sustain life, or for any other application in which the failure of the SCILLC product could create a situation where personal injury or death may occur. Should Buyer purchase or use SCILLC products for any such unintended or unauthorized application, Buyer shall indemnify and hold SCILLC and its officers, employees, subsidiaries, affiliates, and distributors harmless against all claims, costs, damages, and expenses, and reasonable attorney fees arising out of, directly or indirectly, any claim of personal injury or death associated with such unintended or unauthorized use, even if such claim alleges that SCILLC was negligent regarding the design or manufacture of the part. SCILLC is an Equal Opportunity/Affirmative Action Employer. This literature is subject to all applicable copyright laws and is not for resale in any manner.

PUBLICATION ORDERING INFORMATION

LITERATURE FULFILLMENT:
Literature Distribution Center for ON Semiconductor
P.O. Box 5163, Denver, Colorado 80217 USA
Phone: 303-675-2175 or 800-344-3860 Toll Free USA/Canada
Fax: 303-675-2176 or 800-344-3867 Toll Free USA/Canada
Email: orderlit@onsemi.com

N. American Technical Support: 800-282-9855 Toll Free
USA/Canada
Europe, Middle East and Africa Technical Support:
Phone: 421 33 790 2910
Japan Customer Focus Center
Phone: 81-3-5773-3850

ON Semiconductor Website: www.onsemi.com
Order Literature: <http://www.onsemi.com/orderlit>

For additional information, please contact your local Sales Representative