

SN74LS168

BCD DECADE 16 BINARY SYNCHRONOUS BI-DIRECTIONAL COUNTERS

The SN54/74LS168 is a fully synchronous 4-stage up/down counter featuring a preset capability for programmable operation, carry lookahead for easy cascading and a U/D input to control the direction of counting. The SN54/74LS168 counts in a BCD decade (8, 4, 2, 1) sequence. All state changes, whether in counting or parallel loading, are initiated by the LOW-to-HIGH transition of the clock.

- Low Power Dissipation 100 mW Typical
- High-Speed Count Frequency 30 MHz Typical
- Fully Synchronous Operation
- Full Carry Lookahead for Easy Cascading
- Single Up/Down Control Input
- Positive Edge-Trigger Operation
- Input Clamp Diodes Limit High-Speed Termination Effects

CONNECTION DIAGRAM DIP (TOP VIEW)

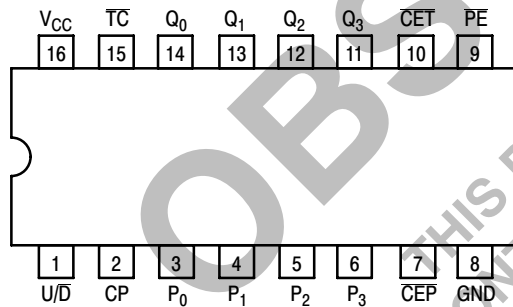

NOTE:
The Flatpak version has the same pinouts (Connection Diagram) as the Dual In-Line Package.



ON Semiconductor®

<http://onsemi.com>

BCD DECADE 16 BINARY SYNCHRONOUS BI-DIRECTIONAL COUNTERS LOW POWER SCHOTTKY

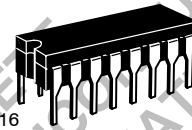

J SUFFIX
CERAMIC
CASE 620-09

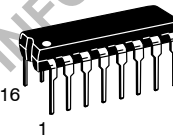

N SUFFIX
PLASTIC
CASE 648-08

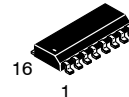

D SUFFIX
SOIC
CASE 751B-03

PIN NAMES

CEP	Count Enable Parallel (Active LOW) Input
CET	Count Enable Trickle (Active LOW) Input
CP	Clock Pulse (Active positive going edge) Input
PE	Parallel Enable (Active LOW) Input
U/D	Up-Down Count Control Input
P ₀ -P ₃	Parallel Data Inputs
Q ₀ -Q ₃	Flip-Flop Outputs
TC	Terminal Count (Active LOW) Output

LOADING (Note a)

	HIGH	LOW
CEP	0.5 U.L.	0.25 U.L.
CET	1.0 U.L.	0.5 U.L.
CP	0.5 U.L.	0.25 U.L.
PE	0.5 U.L.	0.25 U.L.
U/D	0.5 U.L.	0.25 U.L.
P ₀ -P ₃	0.5 U.L.	0.25 U.L.
Q ₀ -Q ₃	10 U.L.	5 (2.5) U.L.
TC	10 U.L.	5 (2.5) U.L.

NOTES:

- 1 TTL Unit Load (U.L.) = 40 μA HIGH/1.6 mA LOW.
- The Output LOW drive factor is 2.5 U.L. for Military (54) and 5 U.L. for Commercial (74) Temperature Ranges.

ORDERING INFORMATION

SN54LSXXXJ	Ceramic
SN74LSXXXN	Plastic
SN74LSXXXD	SOIC

LOGIC SYMBOL

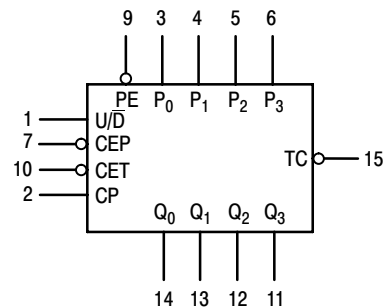

V_{CC} = PIN 16
GND = PIN 8

SN74LS168

STATE DIAGRAM

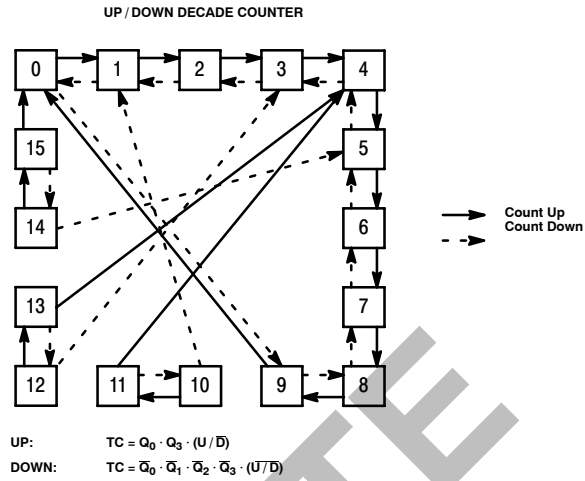

LOGIC DIAGRAM

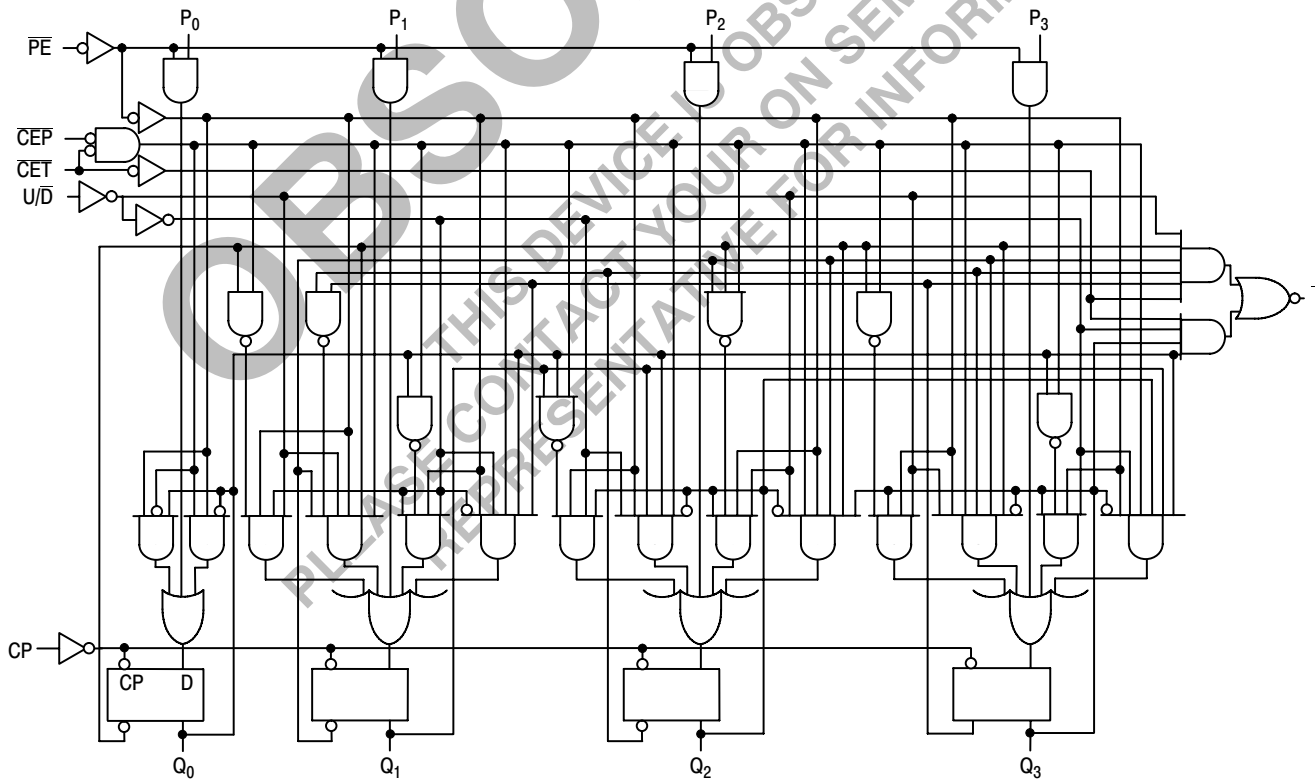

SN74LS168

GUARANTEED OPERATING RANGES

Symbol	Parameter		Min	Typ	Max	Unit
V _{CC}	Supply Voltage	54	4.5	5.0	5.5	V
		74	4.75	5.0	5.25	
T _A	Operating Ambient Temperature Range	54	-55	25	125	°C
		74	0	25	70	
I _{OH}	Output Current — High	54, 74			-0.4	mA
I _{OL}	Output Current — Low	54			4.0	mA
		74			8.0	

DC CHARACTERISTICS OVER OPERATING TEMPERATURE RANGE (unless otherwise specified)

Symbol	Parameter	Limits			Unit	Test Conditions
		Min	Typ	Max		
V _{IH}	Input HIGH Voltage	2.0			V	Guaranteed Input HIGH Voltage for All Inputs
V _{IL}	Input LOW Voltage	54		0.7	V	Guaranteed Input LOW Voltage for All Inputs
		74		0.8		
V _{IK}	Input Clamp Diode Voltage		-0.65	-1.5	V	V _{CC} = MIN, I _{IN} = -18 mA
V _{OH}	Output HIGH Voltage	54	2.5	3.5	V	V _{CC} = MIN, I _{OH} = MAX, V _{IN} = V _{IH} or V _{IL} per Truth Table
		74	2.7	3.5	V	
V _{OL}	Output LOW Voltage	54, 74	0.25	0.4	V	I _{OL} = 4.0 mA I _{OL} = 8.0 mA V _{CC} = V _{CC} MIN, V _{IN} = V _{IL} or V _{IH} per Truth Table
		74	0.35	0.5	V	
I _{IH}	Input HIGH Current Other Inputs CET Input			20 40	μA	V _{CC} = MAX, V _{IN} = 2.7 V
	Other Input CET Input			0.1 0.2	mA	V _{CC} = MAX, V _{IN} = 7.0 V
I _{IL}	Input LOW Current Other Input CET Input			-0.4 -0.8	mA	V _{CC} = MAX, V _{IN} = 0.4 V
I _{OS}	Short Circuit Current (Note 1)	-20		-100	mA	V _{CC} = MAX
I _{CC}	Power Supply Current			34	mA	V _{CC} = MAX

Note 1: Not more than one output should be shorted at one time, nor for more than 1 second.

FUNCTIONAL DESCRIPTION

The SN54/74LS168 uses edge-triggered D-type flip-flops that have no constraints on changing the control or data input signals in either state of the Clock. The only requirement is that the various inputs attain the desired state at least a set-up time before the rising edge of the clock and remain valid for the recommended hold time thereafter.

The parallel load operation takes precedence over the other operations, as indicated in the Mode Select Table. When PE is LOW, the data on the P₀-P₃ inputs enters the flip-flops on the next rising edge of the Clock. In order for counting to occur, both $\overline{\text{CEP}}$ and $\overline{\text{CET}}$ must be LOW and PE must be HIGH. The U/D input then determines the direction of counting.

The Terminal Count ($\overline{\text{TC}}$) output is normally HIGH and goes LOW, provided that $\overline{\text{CET}}$ is LOW, when a counter reaches zero in the COUNT DOWN mode or reaches 15 (9 for the SN54/74LS168) in the COUNT UP mode. The $\overline{\text{TC}}$ output state is not a function of the Count Enable Parallel ($\overline{\text{CEP}}$) input level. The $\overline{\text{TC}}$ output of the SN54/74LS168 decade counter can also be LOW in the illegal states 11, 13 and 15, which can occur when power is turned on or via parallel loading. If illegal state occurs, the SN54/74LS168 will return to the legitimate sequence within two counts. Since the $\overline{\text{TC}}$ signal is derived by decoding the flip-flop states, there exists the possibility of decoding spikes on $\overline{\text{TC}}$. For this reason the use of $\overline{\text{TC}}$ as a clock signal is not recommended.

SN74LS168

MODE SELECT TABLE

PE	CEP	CET	U/D	Action on Rising Clock Edge
L	X	X	X	Load (Pn → Qn)
H	L	L	H	Count Up (increment)
H	L	L	L	Count Down (decrement)
H	H	X	X	No Change (Hold)
H	X	H	X	No Change (Hold)

H = HIGH Voltage Level
 L = LOW Voltage Level
 X = Immaterial

AC CHARACTERISTICS (T_A = 25°C, V_{CC} = 5.0 V)

Symbol	Parameter	Limits			Unit	Test Conditions
		Min	Typ	Max		
f _{MAX}	Maximum Clock Frequency	25	32		MHz	V _{CC} = 5.0 V C _L = 15 pF
t _{PLH} t _{PHL}	Propagation Delay, Clock to TC		23 23	35 35	ns	
t _{PLH} t _{PHL}	Propagation Delay, Clock to any Q		13 15	20 23	ns	
t _{PLH} t _{PHL}	Propagation Delay, CET to TC		15 15	20 20	ns	
t _{PLH} t _{PHL}	Propagation Delay, U/D to TC		17 19	25 29	ns	

AC SETUP REQUIREMENTS (T_A = 25°C)

Symbol	Parameter	Limits			Unit	Test Conditions
		Min	Typ	Max		
t _w	Clock Pulse Width	25			ns	V _{CC} = 5.0 V
t _s	Setup Time, Data or Enable	20			ns	
t _s	Setup Time PE	25			ns	
t _s	Setup Time U/D	30			ns	
t _h	Hold Time Any Input	0			ns	

AC WAVEFORMS

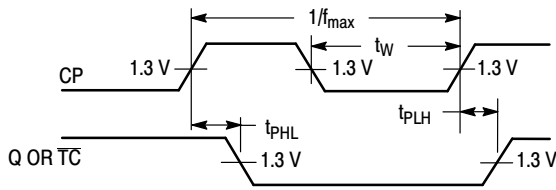

Figure 1. Clock to Output Delays, Count Frequency, and Clock Pulse Width

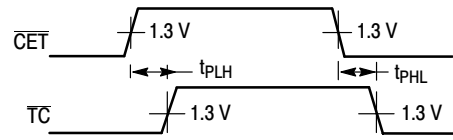

Figure 2. Count Enable Trickle Input To Terminal Count Output Delays

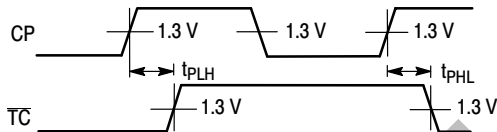

Figure 3. Clock to Terminal Delays

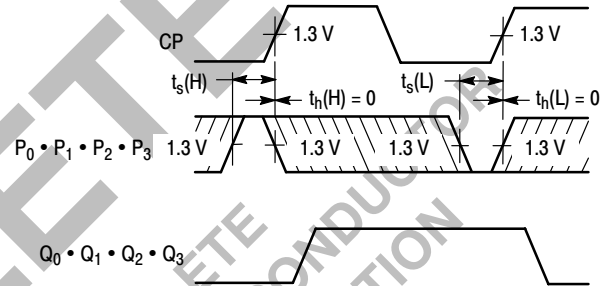
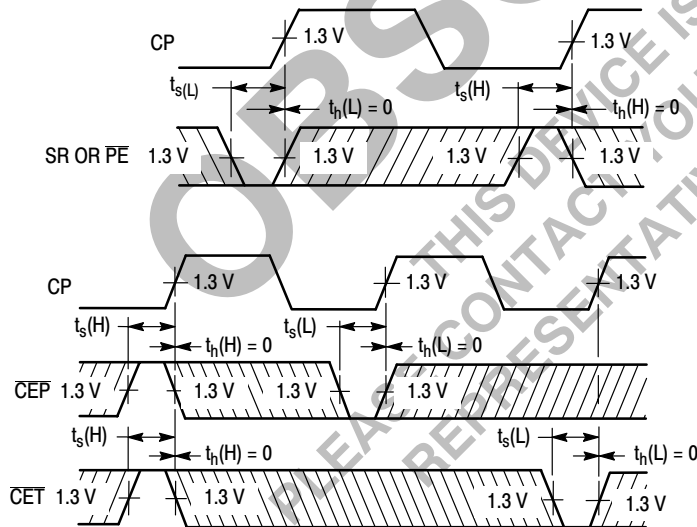

Figure 4. Setup Time (t_s) and Hold (t_h) for Parallel Data Inputs



The shaded areas indicate when the input is permitted to change for predictable output performance.

Figure 5. Setup Time and Hold Time for Count Enable and Parallel Enable Inputs, and Up-Down Control Inputs

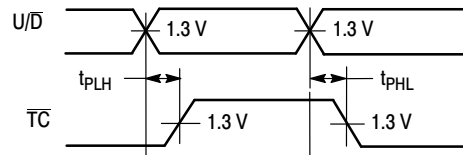



Figure 6. Up-Down Input to Terminal Count Output Delays

OBSOLETE
 THIS DEVICE IS OBSOLETE
 PLEASE CONTACT YOUR ON SEMICONDUCTOR
 REPRESENTATIVE FOR INFORMATION

ON Semiconductor and  are registered trademarks of Semiconductor Components Industries, LLC (SCILLC). SCILLC reserves the right to make changes without further notice to any products herein. SCILLC makes no warranty, representation or guarantee regarding the suitability of its products for any particular purpose, nor does SCILLC assume any liability arising out of the application or use of any product or circuit, and specifically disclaims any and all liability, including without limitation special, consequential or incidental damages. "Typical" parameters which may be provided in SCILLC data sheets and/or specifications can and do vary in different applications and actual performance may vary over time. All operating parameters, including "Typicals" must be validated for each customer application by customer's technical experts. SCILLC does not convey any license under its patent rights nor the rights of others. SCILLC products are not designed, intended, or authorized for use as components in systems intended for surgical implant into the body, or other applications intended to support or sustain life, or for any other application in which the failure of the SCILLC product could create a situation where personal injury or death may occur. Should Buyer purchase or use SCILLC products for any such unintended or unauthorized application, Buyer shall indemnify and hold SCILLC and its officers, employees, subsidiaries, affiliates, and distributors harmless against all claims, costs, damages, and expenses, and reasonable attorney fees arising out of, directly or indirectly, any claim of personal injury or death associated with such unintended or unauthorized use, even if such claim alleges that SCILLC was negligent regarding the design or manufacture of the part. SCILLC is an Equal Opportunity/Affirmative Action Employer. This literature is subject to all applicable copyright laws and is not for resale in any manner.

PUBLICATION ORDERING INFORMATION

LITERATURE FULFILLMENT:

Literature Distribution Center for ON Semiconductor
 P.O. Box 5163, Denver, Colorado 80217 USA
Phone: 303-675-2175 or 800-344-3860 Toll Free USA/Canada
Fax: 303-675-2176 or 800-344-3867 Toll Free USA/Canada
Email: orderlit@onsemi.com

N. American Technical Support: 800-282-9855 Toll Free
 USA/Canada
Europe, Middle East and Africa Technical Support:
 Phone: 421 33 790 2910
Japan Customer Focus Center
 Phone: 81-3-5773-3850

ON Semiconductor Website: www.onsemi.com

Order Literature: <http://www.onsemi.com/orderlit>

For additional information, please contact your local
 Sales Representative