

SN75174 QUADRUPLE DIFFERENTIAL LINE DRIVER

SLLS039B – OCTOBER 1980 – REVISED MAY 1995

- Meets or Exceeds the Requirements of ANSI Standards EIA/TIA-422-B and RS-485 and ITU Recommendation V.11.
- Designed for Multipoint Transmission on Long Bus Lines in Noisy Environments
- 3-State Outputs
- Common-Mode Output Voltage Range of -7 V to 12 V
- Active-High Enable
- Thermal Shutdown Protection
- Positive- and Negative-Current Limiting
- Operates From Single 5-V Supply
- Low Power Requirements
- Functionally Interchangeable With MC3487

description

The SN75174 is a monolithic quadruple differential line driver with 3-state outputs. It is designed to meet the requirements of ANSI Standards EIA/TIA-422-B and RS-485 and ITU Recommendation V.11. The device is optimized for balanced multipoint bus transmission at rates up to 4 megabaud. Each driver features wide positive and negative common-mode output voltage ranges making it suitable for party-line applications in noisy environments.

The SN75174 provides positive- and negative-current limiting and thermal shutdown for protection from line fault conditions on the transmission bus line. Shutdown occurs at a junction temperature of approximately 150°C . This device offers optimum performance when used with the SN75173 or SN75175 quadruple differential line receivers.

The SN75174 is characterized for operation from 0°C to 70°C .

FUNCTION TABLE
(each driver)

INPUT	ENABLE	OUTPUTS	
		Y	Z
H	H	H	L
L	H	L	H
X	L	Z	Z

H = TTL high level, X = irrelevant,
L = TTL low level, Z = high impedance (off)

N PACKAGE
(TOP VIEW)

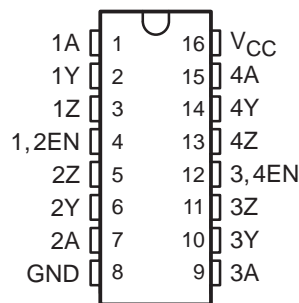

DW PACKAGE
(TOP VIEW)

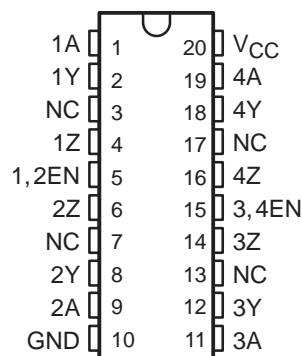

NC – No internal connection



Please be aware that an important notice concerning availability, standard warranty, and use in critical applications of Texas Instruments semiconductor products and disclaimers thereto appears at the end of this data sheet.

PRODUCTION DATA information is current as of publication date. Products conform to specifications per the terms of Texas Instruments standard warranty. Production processing does not necessarily include testing of all parameters.

 **TEXAS
INSTRUMENTS**

POST OFFICE BOX 655303 • DALLAS, TEXAS 75265

Copyright © 1995, Texas Instruments Incorporated

SN75174 QUADRUPLE DIFFERENTIAL LINE DRIVER

SLLS039B – OCTOBER 1980 – REVISED MAY 1995

logic symbol†

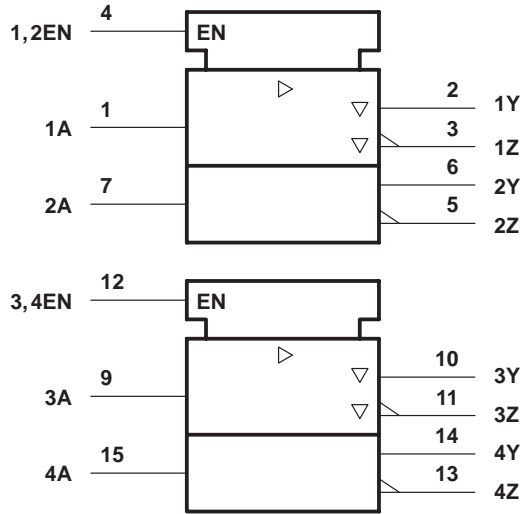

logic diagram, each driver (positive logic)

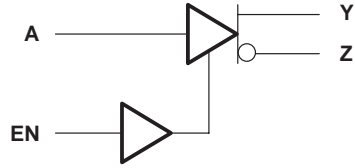

† This symbol is in accordance with ANSI/IEEE Std 91-1984 and IEC Publication 617-12.

schematics of inputs and outputs

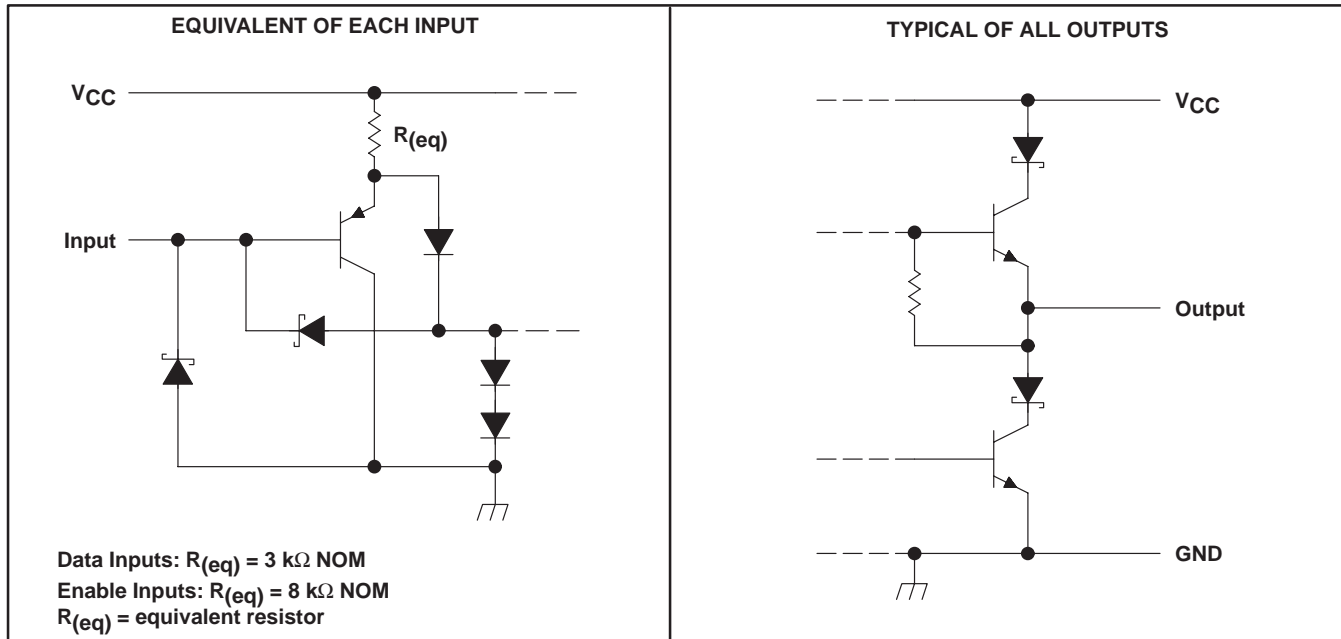

SN75174 QUADRUPLE DIFFERENTIAL LINE DRIVER

SLLS039B – OCTOBER 1980 – REVISED MAY 1995

absolute maximum ratings over operating free-air temperature (unless otherwise noted)†

Supply voltage, V_{CC} (see Note 1)	7 V
Output voltage range, V_O	–10 V to 15 V
Input voltage, V_I	5.5 V
Continuous total dissipation	See Dissipation Rating Table
Operating free-air temperature range, T_A	0°C to 70°C
Storage temperature range, T_{stg}	–65°C to 150°C
Lead temperature 1,6 mm (1/16 inch) from case for 10 seconds	260°C

† Stresses beyond those listed under “absolute maximum ratings” may cause permanent damage to the device. These are stress ratings only, and functional operation of the device at these or any other conditions beyond those indicated under “recommended operating conditions” is not implied. Exposure to absolute-maximum-rated conditions for extended periods may affect device reliability.

NOTE 1: All voltage values are with respect to the network ground terminal.

DISSIPATION RATING TABLE

PACKAGE	T _A ≤ 25°C POWER RATING	DERATING FACTOR ABOVE T _A = 25°C	T _A = 70°C POWER RATING
DW	1125 mW	9.0 mW/°C	720 mW
N	1150 mW	9.2 mW/°C	736 mW

recommended operating conditions

	MIN	NOM	MAX	UNIT
Supply voltage, V_{CC}	4.75	5	5.25	V
High-level input voltage, V_{IH}	2			V
Low-level input voltage, V_{IL}			0.8	V
Common-mode output voltage, V_{OC}		–7 to 12		V
High-level output current, I_{OH}			–60	mA
Low-level output current, I_{OL}			60	mA
Operating free-air temperature, T_A	0		70	°C



SN75174 QUADRUPLE DIFFERENTIAL LINE DRIVER

SLLS039B – OCTOBER 1980 – REVISED MAY 1995

electrical characteristics over recommended ranges of supply voltage and operating free-air temperature (unless otherwise noted)

PARAMETER		TEST CONDITIONS		MIN	TYP†	MAX	UNIT
V _{IK}	Input clamp voltage	I _I = -18 mA				-1.5	V
V _{OH}	High-level output voltage	V _{IH} = 2 V, I _{OH} = -33 mA	V _{IL} = 0.8 V,		3.7		V
V _{OL}	Low-level output voltage	V _{IH} = 2 V, I _{OL} = 33 mA	V _{IL} = 0.8 V,		1.1		V
V _O	Output voltage	I _O = 0		0		6	V
V _{OD1}	Differential output voltage	I _O = 0		1.5	6	6	V
V _{OD2}	Differential output voltage	R _L = 100 Ω,	See Figure 1	1/2 V _{OD1} or 2‡			V
		R _L = 54 Ω,	See Figure 1	1.5	2.5	5	V
V _{OD3}	Differential output voltage	See Note 2		1.5		5	V
Δ V _{OD}	Change in magnitude of differential output voltage§					±0.2	V
V _{OC}	Common-mode output voltage¶	R _L = 54 Ω or 100 Ω,	See Figure 1			+3 -1	V
Δ V _{OC}	Change in magnitude of common-mode output voltage§					±0.2	V
I _O	Output current with power off	V _{CC} = 0, V _O = -7 V to 12 V				±100	μA
I _{OZ}	High-impedance-state output current	V _O = -7 V to 12 V				±100	μA
I _{IH}	High-level input current	V _I = 2.7 V				20	μA
I _{IL}	Low-level input current	V _I = 0.5 V				-360	μA
I _{OS}	Short-circuit output current	V _O = -7 V				-180	mA
		V _O = V _{CC}				180	
		V _O = 12 V				500	
I _{CC}	Supply current (all drivers)	No load	Outputs enabled		38	60	mA
			Outputs disabled		18	40	

† All typical values are at V_{CC} = 5 V and T_A = 25°C.

‡ The minimum V_{OD2} with a 100-Ω load is either 1/2 V_{OD1} or 2 V, whichever is greater.

§ Δ|V_{OD}| and Δ|V_{OC}| are the changes in magnitude of V_{OD} and V_{OC}, respectively, that occur when the input is changed from a high level to a low level.

¶ In ANSI Standard EIA/TIA-422-B, V_{OC}, which is the average of the two output voltages with respect to ground, is called output offset voltage, V_{OS}.

NOTE 2: See EIA Standard RS-485.

switching characteristics, V_{CC} = 5 V, T_A = 25°C

PARAMETER		TEST CONDITIONS		MIN	TYP	MAX	UNIT
t _{d(OD)}	Differential-output delay time	R _L = 54 Ω,	See Figure 2		45	65	ns
t _{t(OD)}	Differential-output transition time				80	120	
t _{pZH}	Output enable time to high level	R _L = 110 Ω,	See Figure 3		80	120	ns
t _{pZL}	Output enable time to low level	R _L = 110 Ω,	See Figure 4		55	80	ns
t _{pHZ}	Output disable time from high level	R _L = 110 Ω,	See Figure 3		75	115	ns
t _{pLZ}	Output disable time from low level	R _L = 110 Ω,	See Figure 3		18	30	ns



SN75174 QUADRUPLE DIFFERENTIAL LINE DRIVER

SLLS039B – OCTOBER 1980 – REVISED MAY 1995

SYMBOL EQUIVALENTS

DATA SHEET PARAMETER	EIA/TIA-422-B	RS-485
V_O	V_{oa}, V_{ob}	V_{oa}, V_{ob}
$ V_{OD1} $	V_o	V_o
$ V_{OD2} $	$V_t (R_L = 100 \Omega)$	$V_t (R_L = 54 \Omega)$
$ V_{OD3} $		V_t (Test Termination Measurement 2)
$\Delta V_{OD} $	$ V_t - \bar{V}_t $	$ V_t - \bar{V}_t $
V_{OC}	$ V_{os} $	$ V_{os} $
$\Delta V_{OC} $	$ V_{os} - \bar{V}_{os} $	$ V_{os} - \bar{V}_{os} $
I_{OS}	$ I_{sa} , I_{sb} $	
I_O	$ I_{xa} , I_{xb} $	I_{ia}, I_{ib}

PARAMETER MEASUREMENT INFORMATION

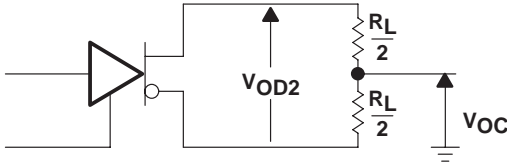
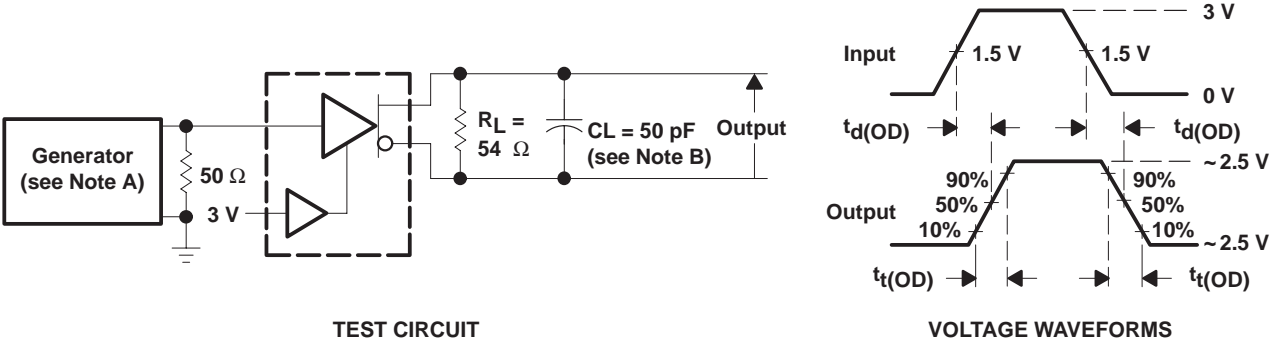

Figure 1. Differential and Common-Mode Output Voltages



- NOTES: A. The input pulse is supplied by a generator having the following characteristics: $t_r \leq 5 \text{ ns}$, $t_f \leq 5 \text{ ns}$, $\text{PRR} \leq 1 \text{ MHz}$, duty cycle = 50%, $Z_O = 50 \Omega$.
 B. C_L includes probe and stray capacitance.

Figure 2. Differential-Output Test Circuit and Voltage Waveforms

SN75174 QUADRUPLE DIFFERENTIAL LINE DRIVER

SLLS039B – OCTOBER 1980 – REVISED MAY 1995

PARAMETER MEASUREMENT INFORMATION

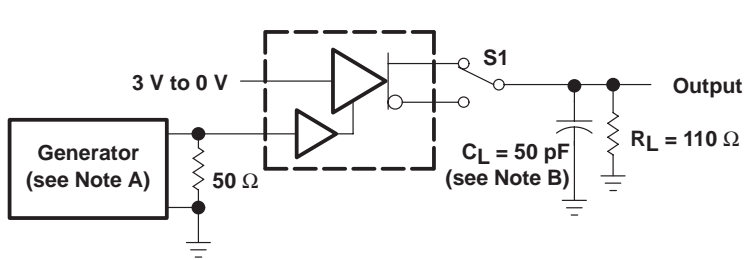

TEST CIRCUIT

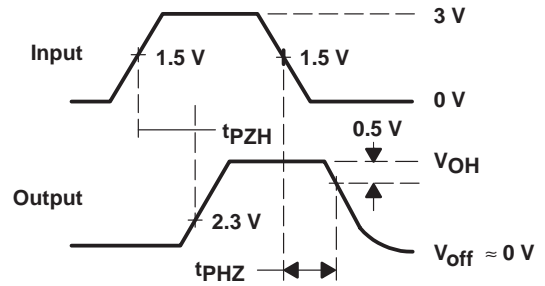

VOLTAGE WAVEFORMS

- NOTES: A. The input pulse is supplied by a generator having the following characteristics: PRR \leq 1 MHz, duty cycle = 50%, $t_r \leq$ 5 ns, $t_f \leq$ 5 ns, $Z_O = 50 \Omega$.
 B. C_L includes probe and stray capacitance.

Figure 3. Test Circuit and Voltage Waveforms

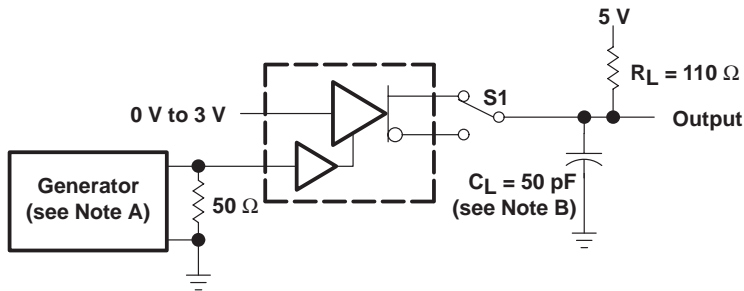

TEST CIRCUIT

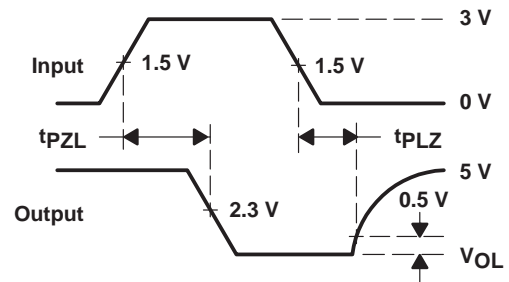

VOLTAGE WAVEFORMS

- NOTES: A. The input pulse is supplied by a generator having the following characteristics: PRR \leq 1 MHz, duty cycle = 50%, $t_r \leq$ 5 ns, $t_f \leq$ 5 ns, $Z_O = 50 \Omega$.
 B. C_L includes probe and stray capacitance.

Figure 4. Test Circuit and Voltage Waveforms

TYPICAL CHARACTERISTICS

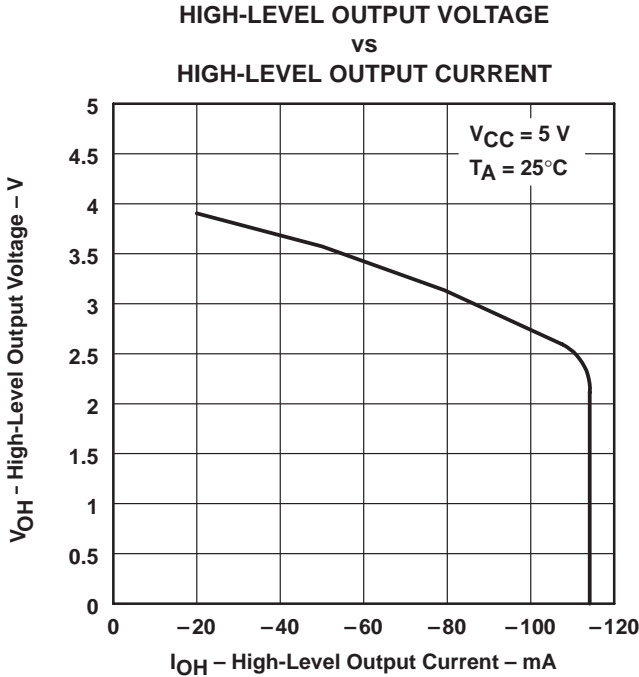

Figure 5

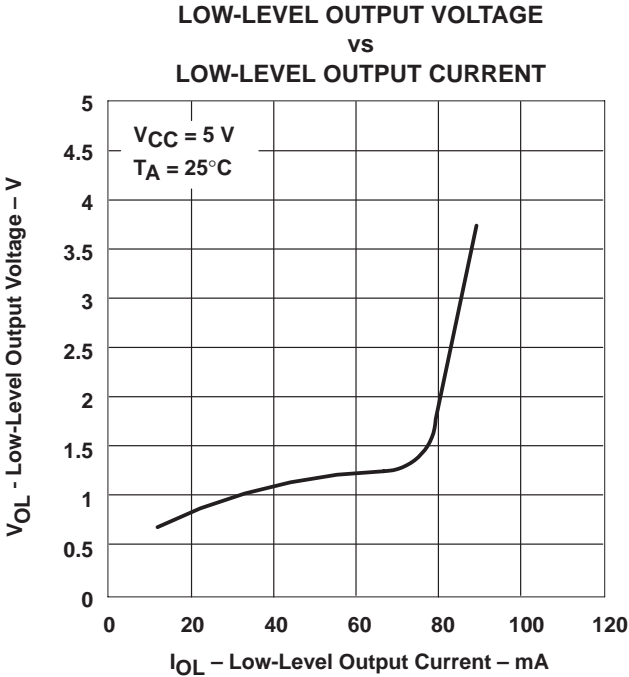

Figure 6

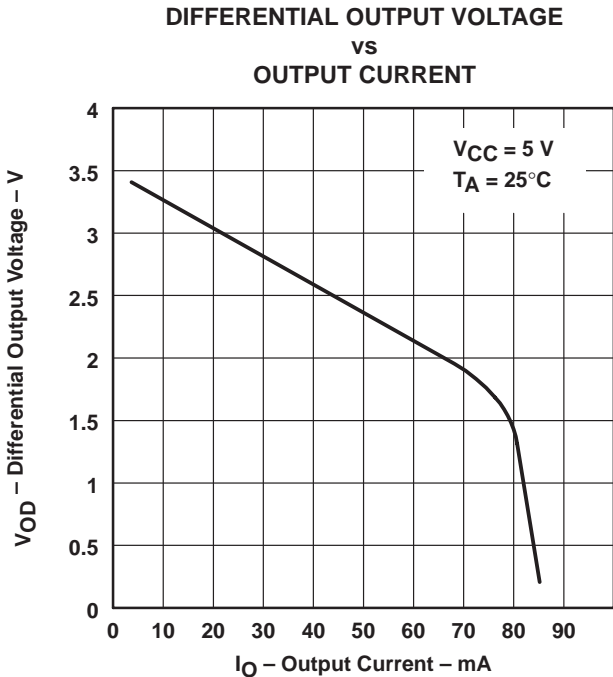

Figure 7

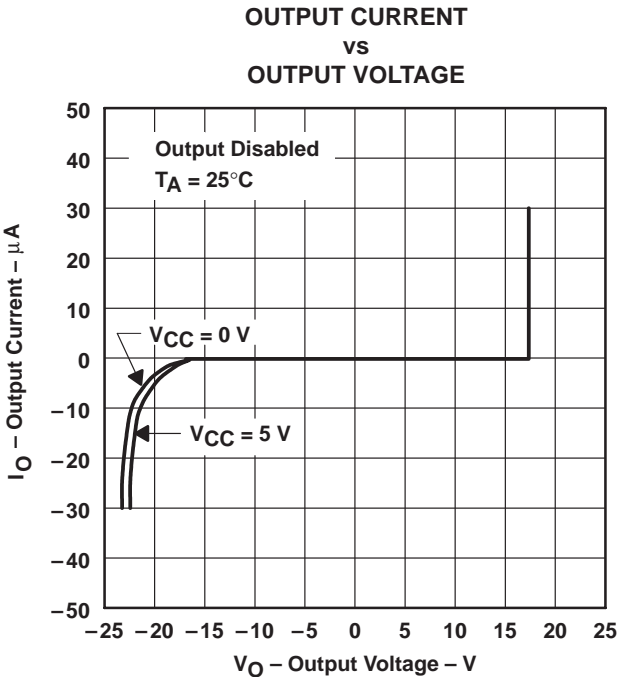

Figure 8

SN75174 QUADRUPLE DIFFERENTIAL LINE DRIVER

SLLS039B – OCTOBER 1980 – REVISED MAY 1995

TYPICAL CHARACTERISTICS

SUPPLY CURRENT
vs
SUPPLY VOLTAGE

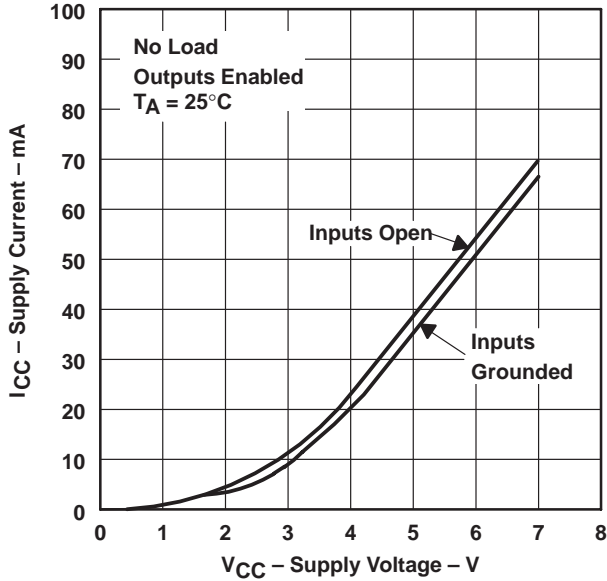

Figure 9

SUPPLY CURRENT
vs
SUPPLY VOLTAGE

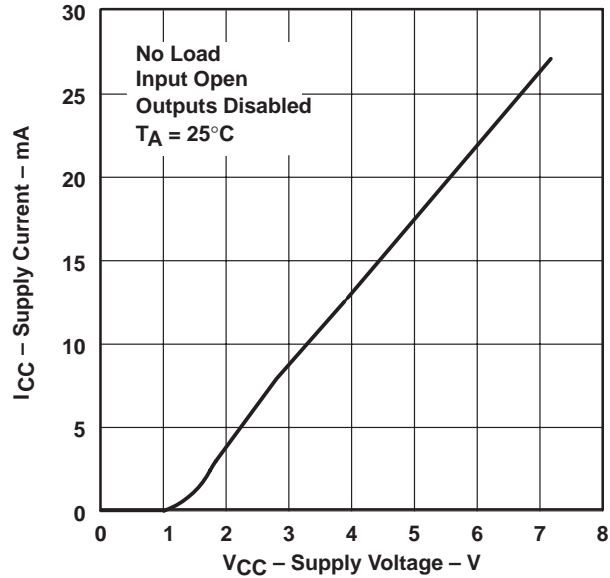
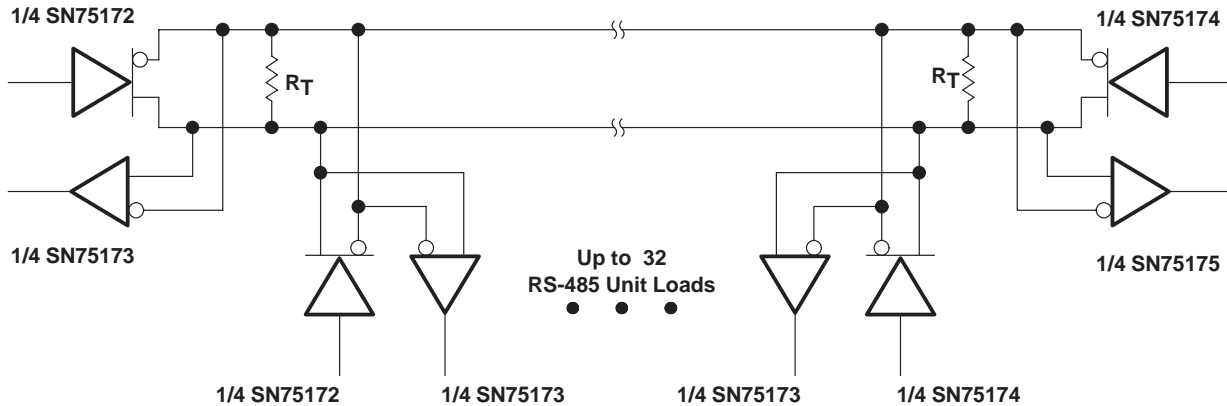

Figure 10

APPLICATION INFORMATION



NOTE: The line length should be terminated at both ends in its characteristic impedance ($R_T = Z_0$). Stub lengths off the main line should be kept as short as possible.

Figure 11. Typical Application Circuit

PACKAGING INFORMATION

Orderable Device	Status (1)	Package Type	Package Drawing	Pins	Package Qty	Eco Plan (2)	Lead finish/ Ball material (6)	MSL Peak Temp (3)	Op Temp (°C)	Device Marking (4/5)	Samples
SN75174DW	ACTIVE	SOIC	DW	20	25	RoHS & Green	NIPDAU	Level-1-260C-UNLIM	0 to 70	SN75174	Samples
SN75174DWR	ACTIVE	SOIC	DW	20	2000	RoHS & Green	NIPDAU	Level-1-260C-UNLIM	0 to 70	SN75174	Samples
SN75174DWRE4	ACTIVE	SOIC	DW	20	2000	RoHS & Green	NIPDAU	Level-1-260C-UNLIM	0 to 70	SN75174	Samples
SN75174DWRG4	ACTIVE	SOIC	DW	20	2000	RoHS & Green	NIPDAU	Level-1-260C-UNLIM	0 to 70	SN75174	Samples
SN75174N	ACTIVE	PDIP	N	16	25	RoHS & Green	NIPDAU	N / A for Pkg Type	0 to 70	SN75174N	Samples
SN75174NE4	ACTIVE	PDIP	N	16	25	RoHS & Green	NIPDAU	N / A for Pkg Type	0 to 70	SN75174N	Samples

(1) The marketing status values are defined as follows:

ACTIVE: Product device recommended for new designs.

LIFEBUY: TI has announced that the device will be discontinued, and a lifetime-buy period is in effect.

NRND: Not recommended for new designs. Device is in production to support existing customers, but TI does not recommend using this part in a new design.

PREVIEW: Device has been announced but is not in production. Samples may or may not be available.

OBSOLETE: TI has discontinued the production of the device.

(2) **RoHS:** TI defines "RoHS" to mean semiconductor products that are compliant with the current EU RoHS requirements for all 10 RoHS substances, including the requirement that RoHS substance do not exceed 0.1% by weight in homogeneous materials. Where designed to be soldered at high temperatures, "RoHS" products are suitable for use in specified lead-free processes. TI may reference these types of products as "Pb-Free".

RoHS Exempt: TI defines "RoHS Exempt" to mean products that contain lead but are compliant with EU RoHS pursuant to a specific EU RoHS exemption.

Green: TI defines "Green" to mean the content of Chlorine (Cl) and Bromine (Br) based flame retardants meet JS709B low halogen requirements of <=1000ppm threshold. Antimony trioxide based flame retardants must also meet the <=1000ppm threshold requirement.

(3) MSL, Peak Temp. - The Moisture Sensitivity Level rating according to the JEDEC industry standard classifications, and peak solder temperature.

(4) There may be additional marking, which relates to the logo, the lot trace code information, or the environmental category on the device.

(5) Multiple Device Markings will be inside parentheses. Only one Device Marking contained in parentheses and separated by a "~" will appear on a device. If a line is indented then it is a continuation of the previous line and the two combined represent the entire Device Marking for that device.

(6) Lead finish/Ball material - Orderable Devices may have multiple material finish options. Finish options are separated by a vertical ruled line. Lead finish/Ball material values may wrap to two lines if the finish value exceeds the maximum column width.

Important Information and Disclaimer: The information provided on this page represents TI's knowledge and belief as of the date that it is provided. TI bases its knowledge and belief on information provided by third parties, and makes no representation or warranty as to the accuracy of such information. Efforts are underway to better integrate information from third parties. TI has taken and continues to take reasonable steps to provide representative and accurate information but may not have conducted destructive testing or chemical analysis on incoming materials and chemicals. TI and TI suppliers consider certain information to be proprietary, and thus CAS numbers and other limited information may not be available for release.

In no event shall TI's liability arising out of such information exceed the total purchase price of the TI part(s) at issue in this document sold by TI to Customer on an annual basis.

TAPE AND REEL INFORMATION

QUADRANT ASSIGNMENTS FOR PIN 1 ORIENTATION IN TAPE

*All dimensions are nominal

Device	Package Type	Package Drawing	Pins	SPQ	Reel Diameter (mm)	Reel Width W1 (mm)	A0 (mm)	B0 (mm)	K0 (mm)	P1 (mm)	W (mm)	Pin1 Quadrant
SN75174DWR	SOIC	DW	20	2000	330.0	24.4	10.8	13.3	2.7	12.0	24.0	Q1

TAPE AND REEL BOX DIMENSIONS



*All dimensions are nominal

Device	Package Type	Package Drawing	Pins	SPQ	Length (mm)	Width (mm)	Height (mm)
SN75174DWR	SOIC	DW	20	2000	367.0	367.0	45.0

N (R-PDIP-T**)

PLASTIC DUAL-IN-LINE PACKAGE

16 PINS SHOWN



- NOTES:
- A. All linear dimensions are in inches (millimeters).
 - B. This drawing is subject to change without notice.
 - Falls within JEDEC MS-001, except 18 and 20 pin minimum body length (Dim A).
 - The 20 pin end lead shoulder width is a vendor option, either half or full width.

DW0020A



PACKAGE OUTLINE

SOIC - 2.65 mm max height

SOIC



4220724/A 05/2016

NOTES:

- All linear dimensions are in millimeters. Dimensions in parenthesis are for reference only. Dimensioning and tolerancing per ASME Y14.5M.
- This drawing is subject to change without notice.
- This dimension does not include mold flash, protrusions, or gate burrs. Mold flash, protrusions, or gate burrs shall not exceed 0.15 mm per side.
- This dimension does not include interlead flash. Interlead flash shall not exceed 0.43 mm per side.
- Reference JEDEC registration MS-013.

EXAMPLE BOARD LAYOUT

DW0020A

SOIC - 2.65 mm max height

SOIC



LAND PATTERN EXAMPLE
SCALE:6X



SOLDER MASK DETAILS

4220724/A 05/2016

NOTES: (continued)

- 6. Publication IPC-7351 may have alternate designs.
- 7. Solder mask tolerances between and around signal pads can vary based on board fabrication site.

EXAMPLE STENCIL DESIGN

DW0020A

SOIC - 2.65 mm max height

SOIC



SOLDER PASTE EXAMPLE
BASED ON 0.125 mm THICK STENCIL
SCALE:6X

4220724/A 05/2016

NOTES: (continued)

8. Laser cutting apertures with trapezoidal walls and rounded corners may offer better paste release. IPC-7525 may have alternate design recommendations.
9. Board assembly site may have different recommendations for stencil design.

IMPORTANT NOTICE AND DISCLAIMER

TI PROVIDES TECHNICAL AND RELIABILITY DATA (INCLUDING DATASHEETS), DESIGN RESOURCES (INCLUDING REFERENCE DESIGNS), APPLICATION OR OTHER DESIGN ADVICE, WEB TOOLS, SAFETY INFORMATION, AND OTHER RESOURCES "AS IS" AND WITH ALL FAULTS, AND DISCLAIMS ALL WARRANTIES, EXPRESS AND IMPLIED, INCLUDING WITHOUT LIMITATION ANY IMPLIED WARRANTIES OF MERCHANTABILITY, FITNESS FOR A PARTICULAR PURPOSE OR NON-INFRINGEMENT OF THIRD PARTY INTELLECTUAL PROPERTY RIGHTS.

These resources are intended for skilled developers designing with TI products. You are solely responsible for (1) selecting the appropriate TI products for your application, (2) designing, validating and testing your application, and (3) ensuring your application meets applicable standards, and any other safety, security, or other requirements. These resources are subject to change without notice. TI grants you permission to use these resources only for development of an application that uses the TI products described in the resource. Other reproduction and display of these resources is prohibited. No license is granted to any other TI intellectual property right or to any third party intellectual property right. TI disclaims responsibility for, and you will fully indemnify TI and its representatives against, any claims, damages, costs, losses, and liabilities arising out of your use of these resources.

TI's products are provided subject to TI's Terms of Sale (<https://www.ti.com/legal/termsofsale.html>) or other applicable terms available either on [ti.com](https://www.ti.com) or provided in conjunction with such TI products. TI's provision of these resources does not expand or otherwise alter TI's applicable warranties or warranty disclaimers for TI products.

Mailing Address: Texas Instruments, Post Office Box 655303, Dallas, Texas 75265
Copyright © 2021, Texas Instruments Incorporated