

Si/SiC Hybrid Module – EliteSiC, 3 Channel Flying Capacitor Boost 1000 V, 200 A IGBT, 1200 V, 60 A SiC Diode, Q2 Package

NXH600B100H4Q2F2S1G, SNXH600B100H4Q2F2S1G-S

The NXH600B100H4Q2S1G is a Si/SiC Hybrid three channel flying capacitor boost module. Each channel contains two 1000 V, 200 A IGBTs, and two 1200 V, 60 A SiC diodes. The module contains an NTC thermistor.

Features

- 3-channel Boost in Q2 Package
- Extremely Efficient Trench with Field Stop Technology
- Low Switching Loss Reduces System Power Dissipation
- Module Design Offers High Power Density
- Low Inductive Layout

Typical Applications

- Solar Inverters
- Uninterruptible Power Supplies Systems

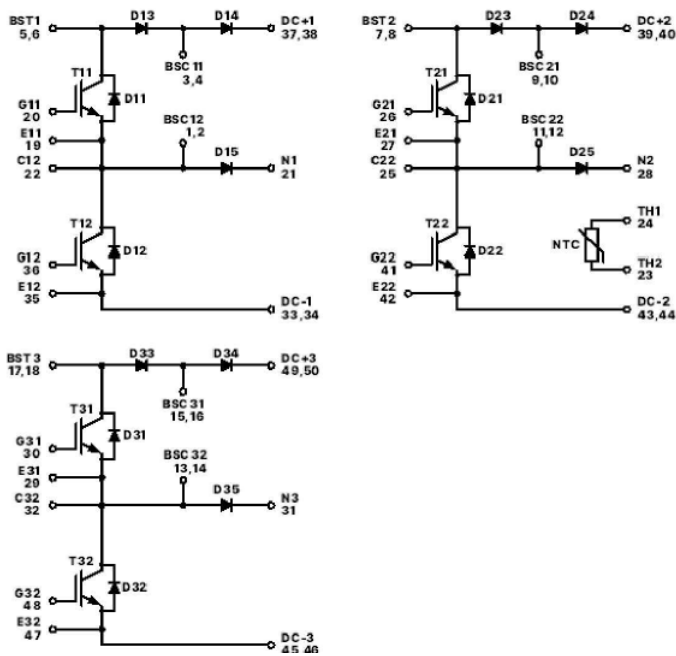
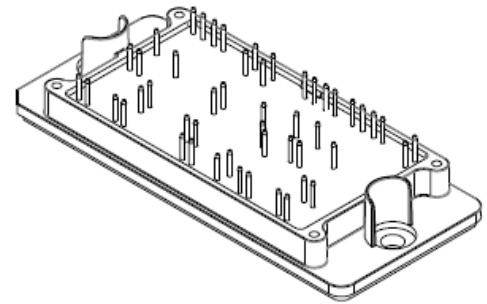
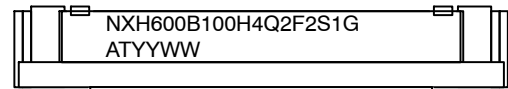

Figure 1. NXH600B100H4Q2F2S1G Schematic Diagram



PIM56, 93x47 (SOLDER PIN)
CASE 180BK

MARKING DIAGRAM



NXH600B100H4Q2F2S1G = Specific Device Code
G = Pb-Free Package
AT = Assembly & Test Site Code
YYWW = Year and Work Week Code

PIN CONNECTIONS

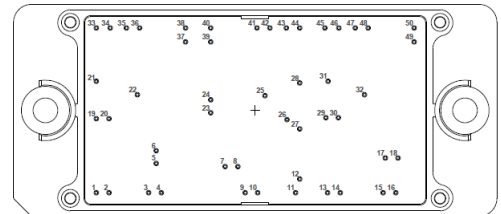

ORDERING INFORMATION

See detailed ordering and shipping information in the package dimensions section on page 4 of this data sheet.

NXH600B100H4Q2F2S1G, SNXH600B100H4Q2F2S1G-S

Table 1. ABSOLUTE MAXIMUM RATINGS (Note 1) ($T_J = 25^\circ\text{C}$ unless otherwise noted)

Rating	Symbol	Value	Unit
IGBT (T11, T12, T21, T22, T31, T32)			
Collector-Emitter Voltage	V_{CES}	1000	V
Gate-Emitter Voltage	V_{GE}	± 20	V
Positive Transient Gate-Emitter Voltage ($t_{\text{pulse}} = 5 \mu\text{s}$, $D < 0.10$)		30	
Continuous Collector Current @ $T_C = 80^\circ\text{C}$	I_C	173	A
Pulsed Peak Collector Current @ $T_C = 80^\circ\text{C}$ ($T_J = 175^\circ\text{C}$)	$I_{C(\text{Pulse})}$	519	A
Maximum Power Dissipation ($T_J = 175^\circ\text{C}$)	P_{tot}	422	W
Minimum Junction Temperature	$T_{J\text{MIN}}$	-40	$^\circ\text{C}$
Maximum Junction Temperature (Note 2)	$T_{J\text{MAX}}$	175	$^\circ\text{C}$

IGBT INVERSE DIODE (D11, D12, D21, D22, D31, D32)

Peak Repetitive Reverse Voltage	V_{RRM}	1200	V
Continuous Forward Current @ $T_C = 80^\circ\text{C}$	I_F	66	A
Repetitive Peak Forward Current ($T_J = 175^\circ\text{C}$)	I_{FRM}	98	A
Maximum Power Dissipation ($T_J = 175^\circ\text{C}$)	P_{tot}	101	W
Minimum Junction Temperature	$T_{J\text{MIN}}$	-40	$^\circ\text{C}$
Maximum Junction Temperature	$T_{J\text{MAX}}$	175	$^\circ\text{C}$

SILICON CARBIDE SCHOTTKY DIODE (D13, D14, D23, D24, D33, D34)

Peak Repetitive Reverse Voltage	V_{RRM}	1200	V
Continuous Forward Current @ $T_C = 80^\circ\text{C}$	I_F	63	A
Repetitive Peak Forward Current ($T_J = 175^\circ\text{C}$)	I_{FRM}	189	A
Maximum Power Dissipation ($T_J = 175^\circ\text{C}$)	P_{tot}	204	W
Minimum Junction Temperature	$T_{J\text{MIN}}$	-40	$^\circ\text{C}$
Maximum Junction Temperature	$T_{J\text{MAX}}$	175	$^\circ\text{C}$

START-UP DIODE (D15, D25, D35)

Peak Repetitive Reverse Voltage	V_{RRM}	1200	V
Continuous Forward Current @ $T_C = 80^\circ\text{C}$	I_F	35	A
Repetitive Peak Forward Current ($T_J = 175^\circ\text{C}$)	I_{FRM}	105	A
Maximum Power Dissipation ($T_J = 175^\circ\text{C}$)	P_{tot}	84	W
Minimum Junction Temperature	$T_{J\text{MIN}}$	-40	$^\circ\text{C}$
Maximum Junction Temperature	$T_{J\text{MAX}}$	175	$^\circ\text{C}$

THERMAL AND INSULATION PROPERTIES

THERMAL PROPERTIES

Operating Temperature under Switching Condition	T_{VJOP}	-40 to 150	$^\circ\text{C}$
Storage Temperature range	T_{stg}	-40 to 125	$^\circ\text{C}$

INSULATION PROPERTIES

Isolation test voltage, $t = 1 \text{ sec}$, 50 Hz	V_{is}	4000	V_{RMS}
Creepage distance		12.7	mm
Comparative tracking index	CTI	>600	

Stresses exceeding those listed in the Maximum Ratings table may damage the device. If any of these limits are exceeded, device functionality should not be assumed, damage may occur and reliability may be affected.

1. Refer to ELECTRICAL CHARACTERISTICS, RECOMMENDED OPERATING RANGES and/or APPLICATION INFORMATION for Safe Operating parameters.
2. Qualification at 175°C per discrete TO247.

NXH600B100H4Q2F2S1G, SNXH600B100H4Q2F2S1G-S

Table 2. ELECTRICAL CHARACTERISTICS ($T_J = 25^\circ\text{C}$ unless otherwise noted)

Parameter	Test Conditions	Symbol	Min	Typ	Max	Unit
-----------	-----------------	--------	-----	-----	-----	------

IGBT (T11, T12, T21, T22, T31, T32) CHARACTERISTICS

Collector-Emitter Breakdown Voltage	$V_{GE} = 0\text{ V}, I_C = 2\text{ mA}$	$V_{(BR)CES}$	1000	1150	-	V	
Collector-Emitter Cutoff Current	$V_{GE} = 0\text{ V}, V_{CE} = 1000\text{ V}$	I_{CES}	-	-	20	μA	
Collector-Emitter Saturation Voltage	$V_{GE} = 15\text{ V}, I_C = 200\text{ A}, T_J = 25^\circ\text{C}$	$V_{CE(sat)}$	-	1.88	2.3	V	
	$V_{GE} = 15\text{ V}, I_C = 200\text{ A}, T_J = 150^\circ\text{C}$		-	2.4	-		
Gate-Emitter Threshold Voltage	$V_{GE} = V_{CE}, I_C = 200\text{ mA}$	$V_{GE(TH)}$	4	4.98	6	V	
Gate Leakage Current	$V_{GE} = \pm 20\text{ V}, V_{CE} = 0\text{ V}$	I_{GES}	-	-	350	nA	
Internal Gate Resistor		r_G	-	3	-	Ω	
Turn-on Delay Time	$T_J = 25^\circ\text{C}$ $V_{CE} = 600\text{ V}, I_C = 50\text{ A}$ $V_{GE} = -9\text{ V}, 15\text{ V}, R_{Gon} = 9\ \Omega, R_{Goff} = 25\ \Omega$	$t_{d(on)}$	-	119.75	-	ns	
Rise Time		t_r	-	30.08	-		
Turn-off Delay Time		$t_{d(off)}$	-	614.57	-		
Fall Time		t_f	-	26.85	-		
Turn-on Switching Loss per Pulse		E_{on}	-	860	-		μJ
Turn off Switching Loss per Pulse		E_{off}	-	1500	-		
Turn-on Delay Time		$T_J = 125^\circ\text{C}$ $V_{CE} = 600\text{ V}, I_C = 50\text{ A}$ $V_{GE} = -9\text{ V}, 15\text{ V}, R_{Gon} = 9\ \Omega, R_{Goff} = 25\ \Omega$	$t_{d(on)}$	-	119.97		-
Rise Time	t_r		-	32.09	-		
Turn-off Delay Time	$t_{d(off)}$		-	706.72	-		
Fall Time	t_f		-	40.22	-		
Turn-on Switching Loss per Pulse	E_{on}		-	1120	-	μJ	
Turn off Switching Loss per Pulse	E_{off}		-	2750	-		
Input Capacitance	$V_{CE} = 20\text{ V}, V_{GE} = 0\text{ V}, f = 1\text{ MHz}$		C_{ies}	-	12687.7	-	pF
Output Capacitance		C_{oes}	-	418.0	-		
Reverse Transfer Capacitance		C_{res}	-	73.9	-		
Total Gate Charge	$V_{CE} = 600\text{ V}, I_C = 40\text{ A}, V_{GE} = -15\text{ V} \sim 15\text{ V}$	Q_g	-	680	-	nC	
Thermal Resistance – chip-to-heatsink	Thermal grease, Thickness = 2.1 Mil $\pm 2\%$, $\lambda = 2.87\text{ W/mK}$	R_{thJH}	-	0.420	-	K/W	
Thermal Resistance – chip-to-case		R_{thJC}	-	0.225	-	K/W	

IGBT INVERSE DIODE (D11, D12, D21, D22, D31, D32) CHARACTERISTICS

Diode Forward Voltage	$I_F = 50\text{ A}, T_J = 25^\circ\text{C}$	V_F	-	1.15	1.5	V
	$I_F = 50\text{ A}, T_J = 175^\circ\text{C}$		-	1.08	-	
Thermal Resistance – chip-to-heatsink	Thermal grease, Thickness = 2.1 Mil $\pm 2\%$, $\lambda = 2.87\text{ W/mK}$	R_{thJH}	-	0.956	-	K/W
Thermal Resistance – chip-to-case		R_{thJC}	-	0.800	-	K/W

DIODES (D13, D14, D23, D24, D33, D34) CHARACTERISTICS

Diode Forward Voltage	$I_F = 60\text{ A}, T_J = 25^\circ\text{C}$	V_F	-	1.51	2.2	V
	$I_F = 60\text{ A}, T_J = 175^\circ\text{C}$		-	2.14	-	
Reverse Recovery Time	$T_J = 25^\circ\text{C}$ $V_{CE} = 600\text{ V}, I_C = 50\text{ A}$ $V_{GE} = -9\text{ V}, 15\text{ V}, R_{Gon} = 9\ \Omega$	t_{rr}	-	28.14	-	ns
Reverse Recovery Charge		Q_{rr}	-	304.98	-	nC
Peak Reverse Recovery Current		I_{RRM}	-	18.8	-	A
Peak Rate of Fall of Recovery Current		di/dt	-	1389.12	-	A/ μs
Reverse Recovery Energy		E_{rr}	-	105.08	-	μJ

NXH600B100H4Q2F2S1G, SNXH600B100H4Q2F2S1G-S

Table 2. ELECTRICAL CHARACTERISTICS ($T_J = 25^\circ\text{C}$ unless otherwise noted) (continued)

Parameter	Test Conditions	Symbol	Min	Typ	Max	Unit
DIODES (D13, D14, D23, D24, D33, D34) CHARACTERISTICS						
Reverse Recovery Time	$T_J = 125^\circ\text{C}$ $V_{CE} = 600\text{ V}, I_C = 50\text{ A}$ $V_{GE} = -9\text{ V}, 15\text{ V}, R_{Gon} = 9\ \Omega$	t_{rr}	–	45.73	–	ns
Reverse Recovery Charge		Q_{rr}	–	583.95	–	nC
Peak Reverse Recovery Current		I_{RRM}	–	24.08	–	A
Peak Rate of Fall of Recovery Current		di/dt	–	1236	–	A/ μs
Reverse Recovery Energy		E_{rr}	–	216.04	–	μJ
Thermal Resistance – chip-to-heatsink	Thermal grease, Thickness = 2.1 Mil $\pm 2\%$, $\lambda = 2.87\text{ W/mK}$	R_{thJH}	–	0.599	–	K/W
Thermal Resistance – chip-to-case		R_{thJC}	–	0.466	–	K/W

START-UP DIODE (D15, D25, D35) CHARACTERISTICS

Diode Forward Voltage	$I_F = 30\text{ A}, T_J = 25^\circ\text{C}$	V_F	–	2.25	3.2	V
	$I_F = 30\text{ A}, T_J = 175^\circ\text{C}$		–	1.8	–	
Thermal Resistance – chip-to-heatsink	Thermal grease, Thickness = 2.1 Mil $\pm 2\%$, $\lambda = 2.87\text{ W/mK}$	R_{thJH}	–	1.309	–	K/W
Thermal Resistance – chip-to-case		R_{thJC}	–	1.133	–	K/W

THERMISTOR CHARACTERISTICS

Nominal resistance	$T = 25^\circ\text{C}$	R_{25}	–	5	–	k Ω
Nominal resistance	$T = 100^\circ\text{C}$	R_{100}	–	492.2	–	Ω
Deviation of R25		$\Delta R/R$	–1	–	1	%
Power dissipation		P_D	–	5	–	mW
Power dissipation constant			–	1.3	–	mW/K
B-value	$B(25/85)$, tolerance $\pm 1\%$		–	3430	–	K

Product parametric performance is indicated in the Electrical Characteristics for the listed test conditions, unless otherwise noted. Product performance may not be indicated by the Electrical Characteristics if operated under different conditions.

ORDERING INFORMATION

Orderable Part Number	Marking	Package	Shipping
NXH600B100H4Q2F2S1G	NXH600B100H4Q2F2S1G	Q2BOOST, Case 180BK (Pb-Free and Halide-Free Solder Pins)	12 Units / Blister Tray
SNXH600B100H4Q2F2S1G-S	SNXH600B100H4Q2F2S1G-S	Q2BOOST, Case 180BK (Pb-Free and Halide-Free Solder Pins)	12 Units / Blister Tray

NXH600B100H4Q2F2S1G, SNXH600B100H4Q2F2S1G-S

TYPICAL CHARACTERISTICS - T11||D13, T12||D14, T21||D23, T22||D24, T31||D33, T32||D34

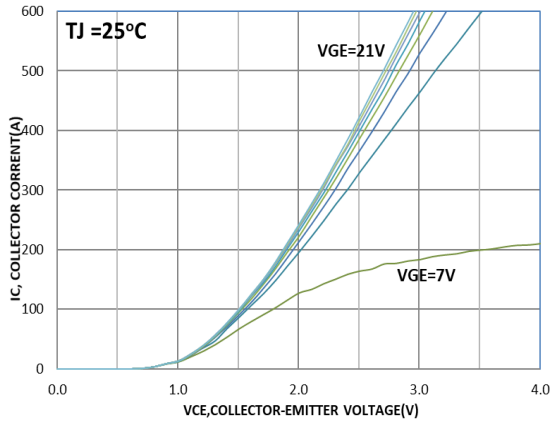

Figure 2. Typical Output Characteristics

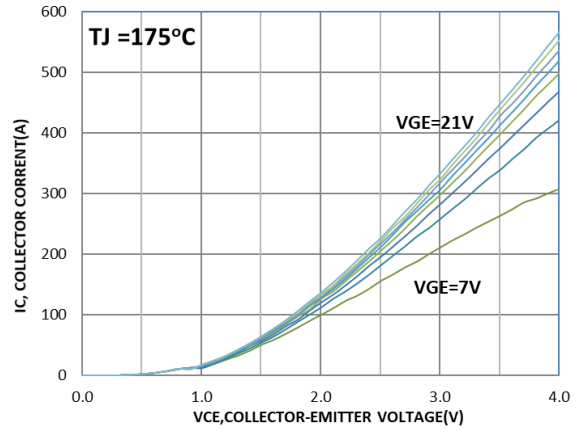

Figure 3. Typical Output Characteristics

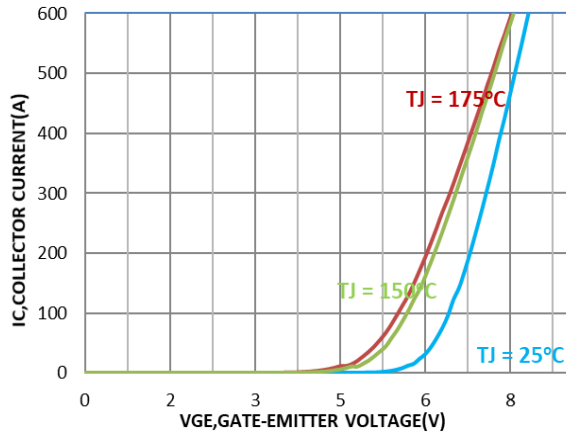

Figure 4. Transfer Characteristics

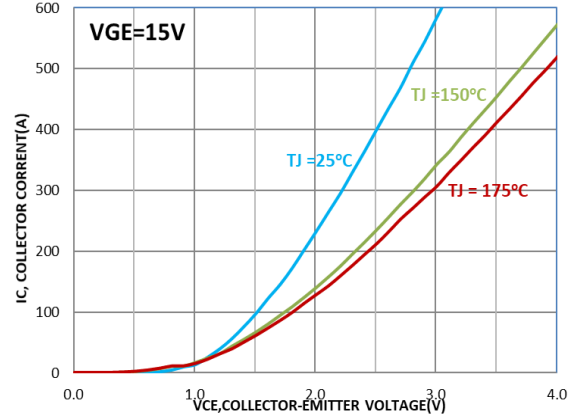

Figure 5. Saturation Voltage Characteristic

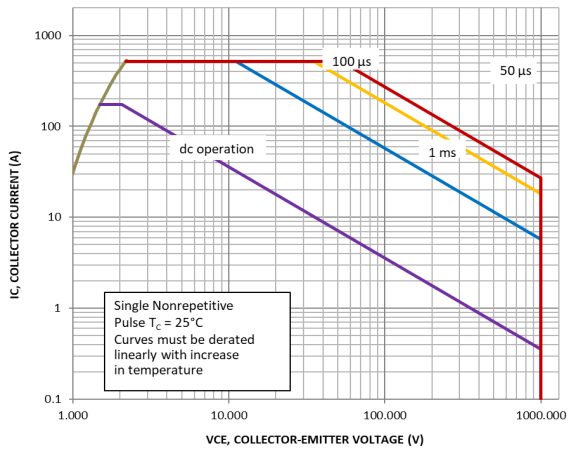

Figure 6. FBSOA

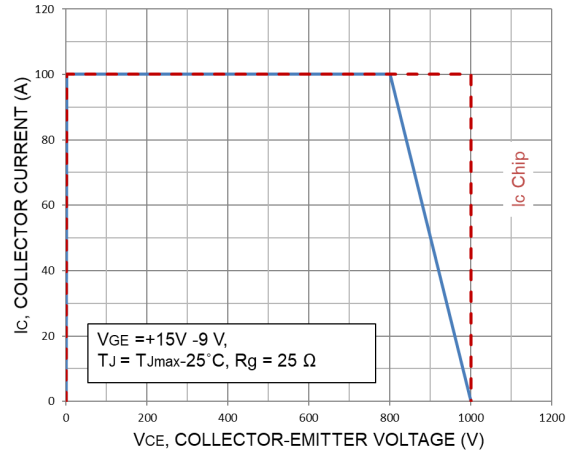

Figure 7. RBSOA

NXH600B100H4Q2F2S1G, SNXH600B100H4Q2F2S1G-S

TYPICAL CHARACTERISTICS – T11||D13, T12||D14, T21||D23, T22||D24, T31||D33, T32||D34 (CONTINUED)

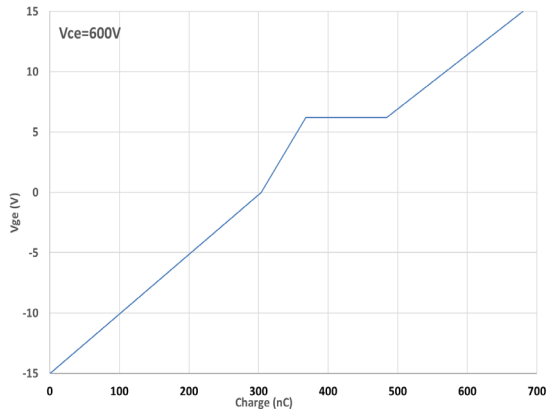

Figure 8. Gate Voltage vs. Gate Charge

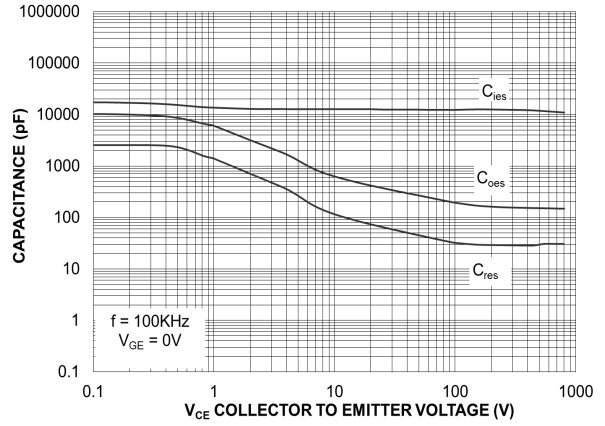

Figure 9. Capacitance

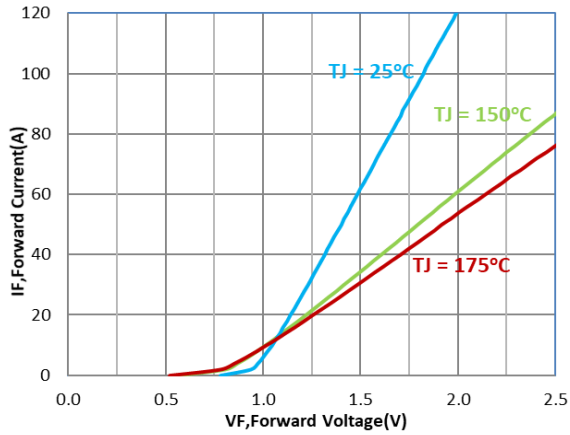

Figure 10. Diode Forward Characteristics

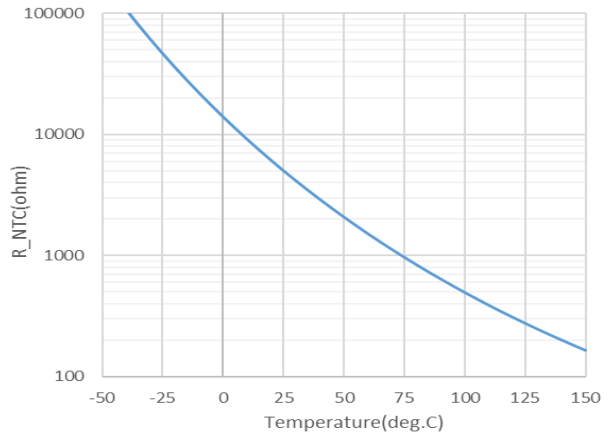

Figure 11. Temperature vs. NTC Value

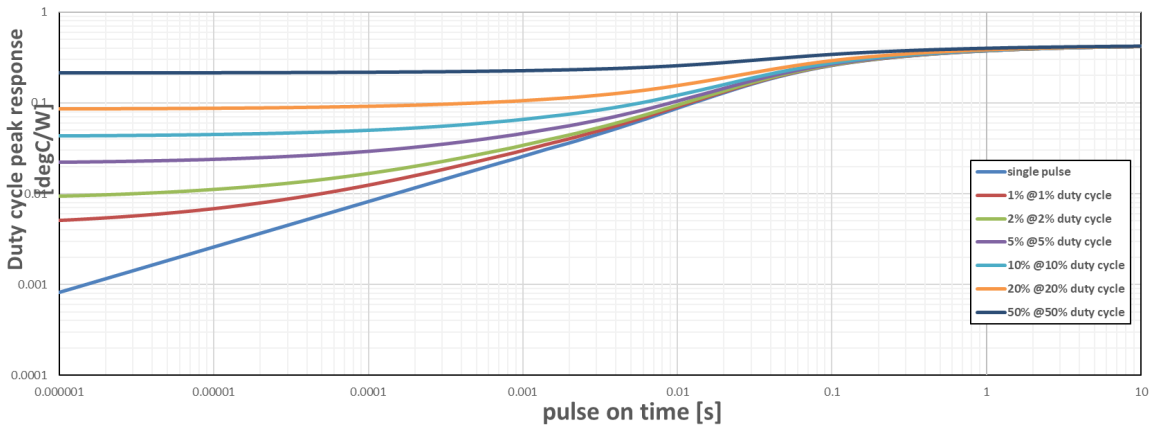

Figure 12. Transient Thermal Impedance (IGBT Rthjc)

NXH600B100H4Q2F2S1G, SNXH600B100H4Q2F2S1G-S

TYPICAL CHARACTERISTICS – T11||D13, T12||D14, T21||D23, T22||D24, T31||D33, T32||D34 (CONTINUED)

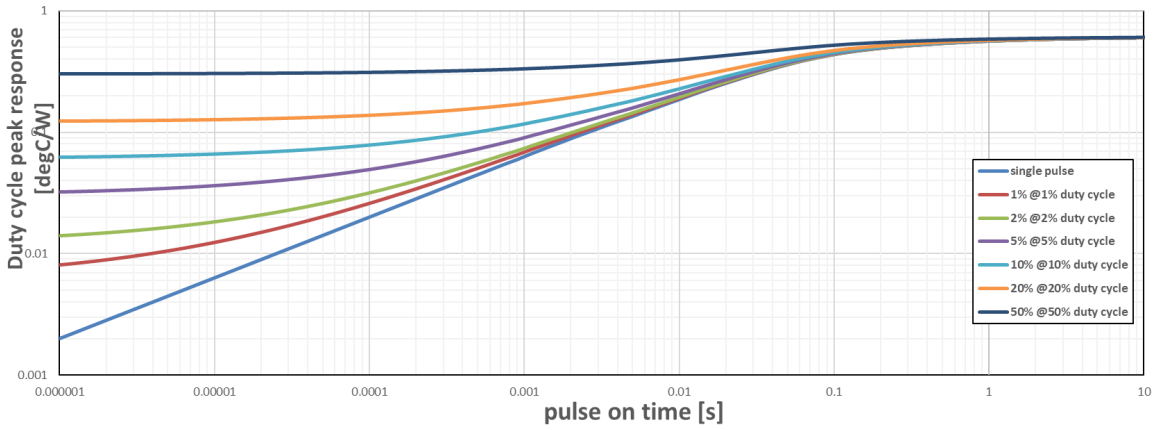

Figure 13. Transient Thermal Impedance (DIODE Rthjc)

TYPICAL CHARACTERISTICS – D11, D12, D21, D22, D31, D32 DIODE

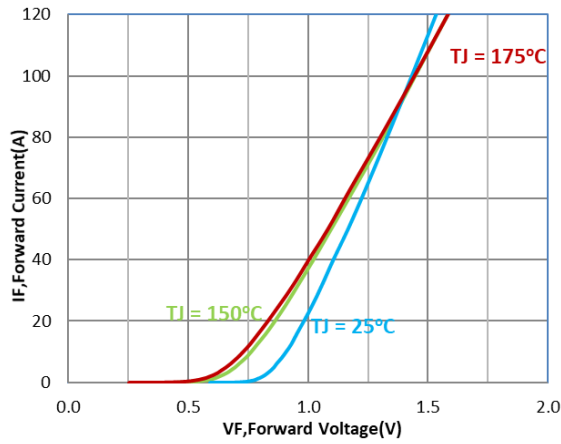

Figure 14. Diode Forward Characteristics

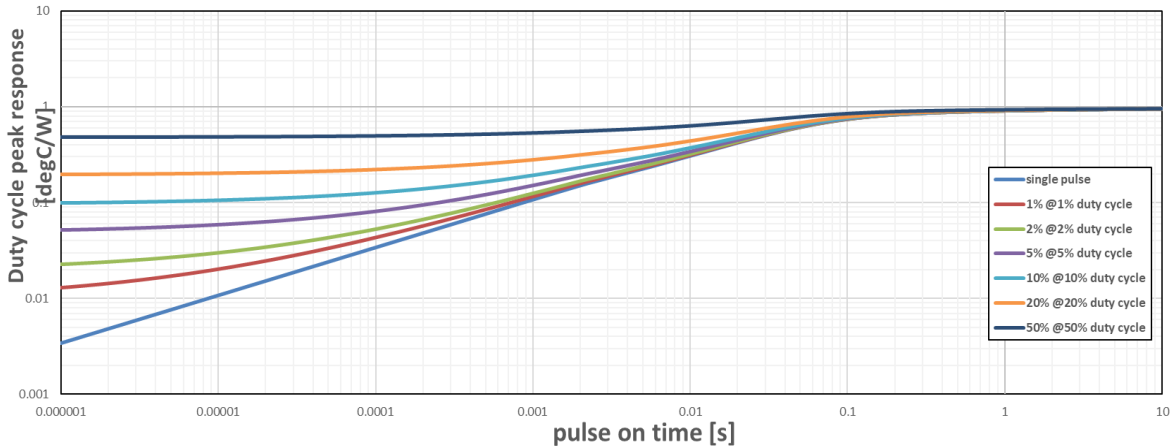

Figure 15. Transient Thermal Impedance (Rthjc)

TYPICAL CHARACTERISTICS – D15, D25, D35 DIODE

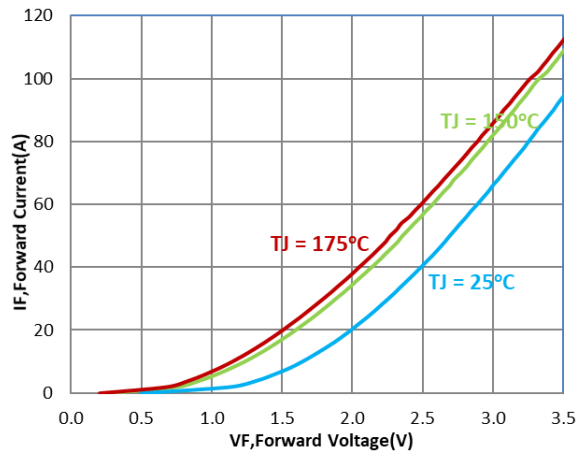

Figure 16. Diode Forward Characteristics

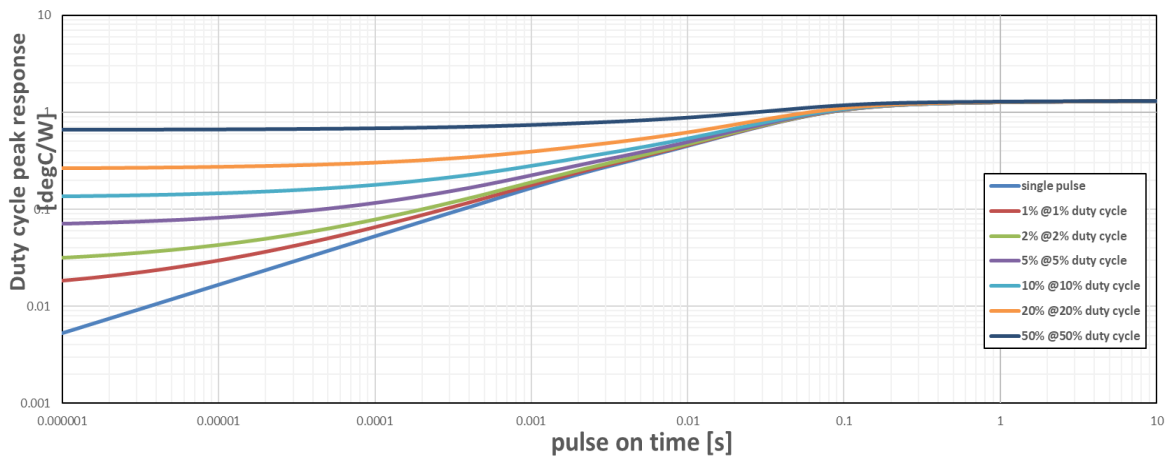

Figure 17. Transient Thermal Impedance ($R_{th(jc)}$)

NXH600B100H4Q2F2S1G, SNXH600B100H4Q2F2S1G-S

TYPICAL CHARACTERISTICS – T11||D13, T12||D14, T21||D23, T22||D24, T31||D33, T32||D34

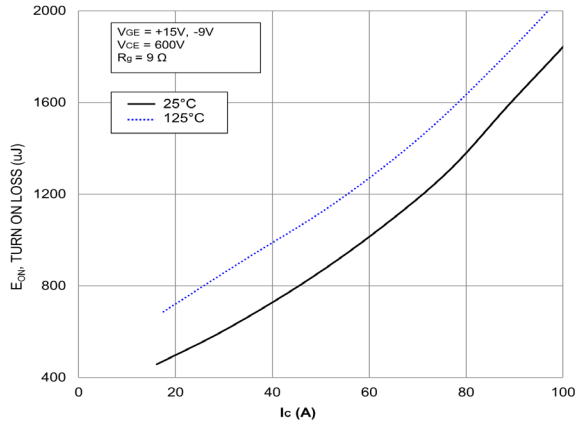

Figure 18. Typical Turn On Loss vs. I_C

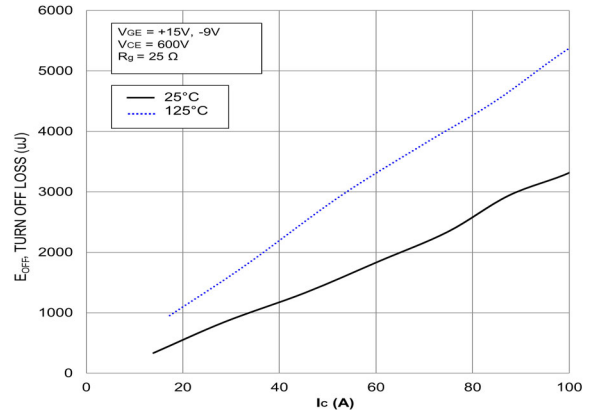

Figure 19. Typical Turn Off Loss vs. I_C

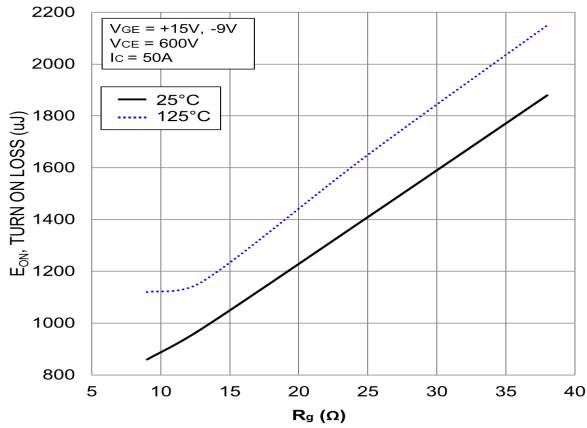

Figure 20. Typical Turn On Loss vs. R_g

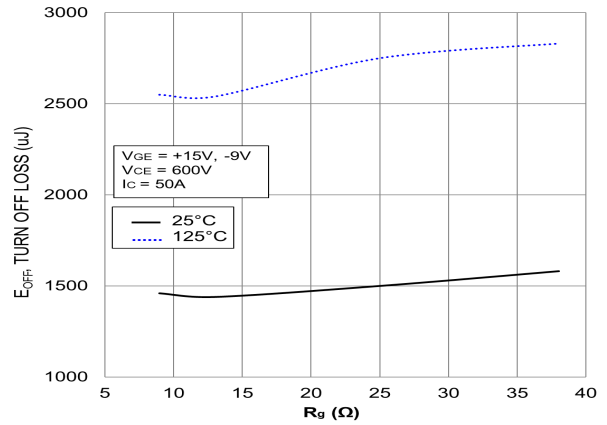

Figure 21. Typical Turn Off Loss vs. R_g

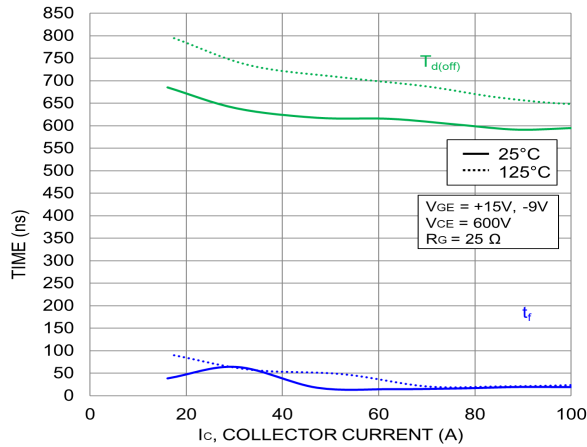

Figure 22. Typical Turn-Off Switching Time vs. I_C

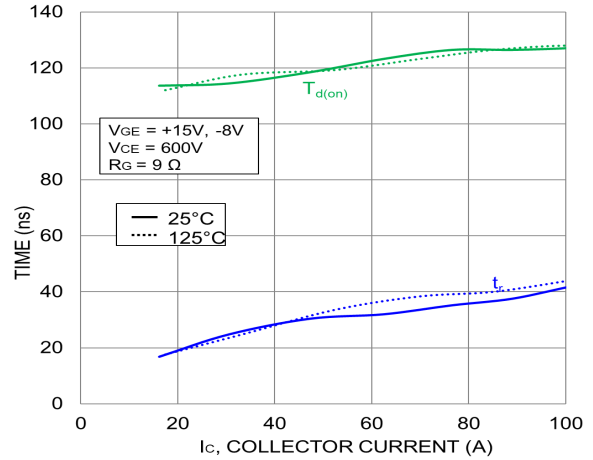

Figure 23. Typical Turn-On Switching Time vs. I_C

NXH600B100H4Q2F2S1G, SNXH600B100H4Q2F2S1G-S

TYPICAL CHARACTERISTICS – T11||D13, T12||D14, T21||D23, T22||D24, T31||D33, T32||D34 (CONTINUED)

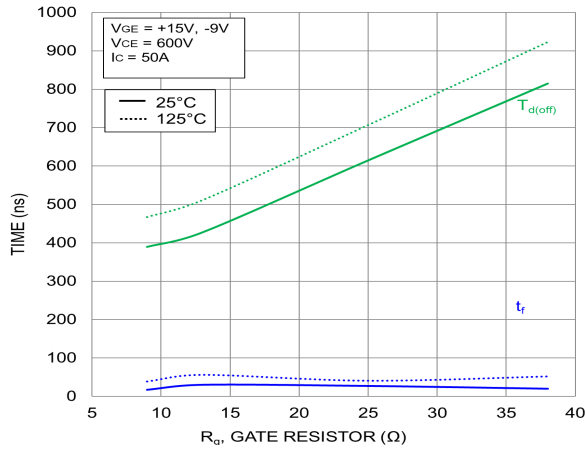

Figure 24. Typical Turn-Off Switching Time vs. R_g

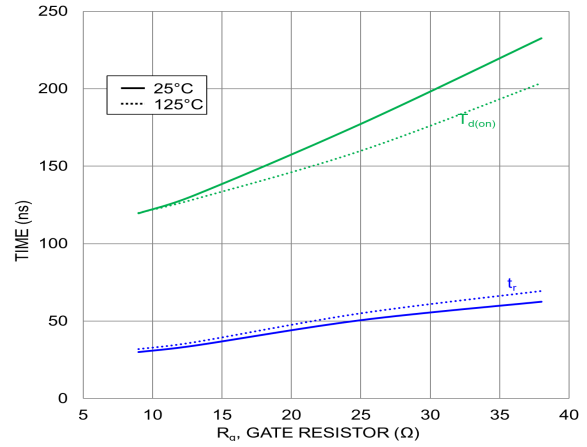

Figure 25. Typical Turn-On Switching Time vs. R_g

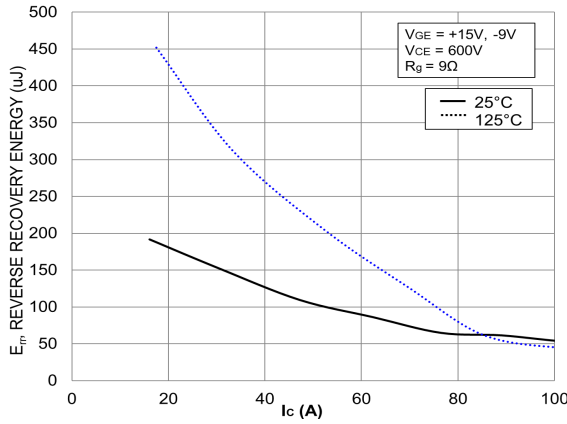

Figure 26. Typical Reverse Recovery Energy Loss vs. I_C

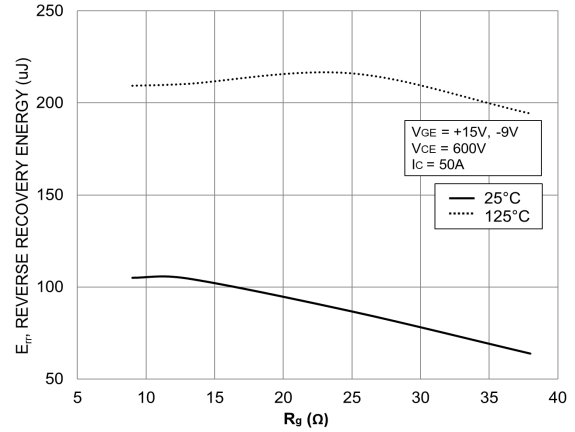

Figure 27. Typical Reverse Recovery Energy Loss vs. R_g

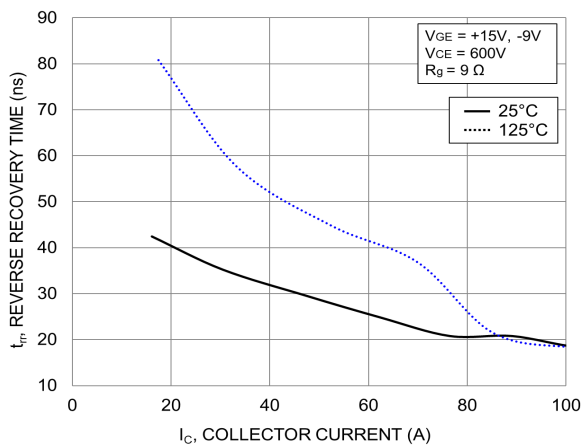

Figure 28. Typical Reverse Recovery Time vs. I_C

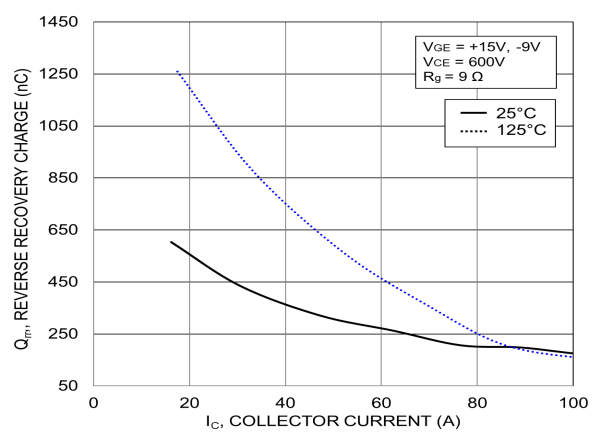

Figure 29. Typical Reverse Recovery Charge vs. I_C

NXH600B100H4Q2F2S1G, SNXH600B100H4Q2F2S1G-S

TYPICAL CHARACTERISTICS – T11||D13, T12||D14, T21||D23, T22||D24, T31||D33, T32||D34 (CONTINUED)

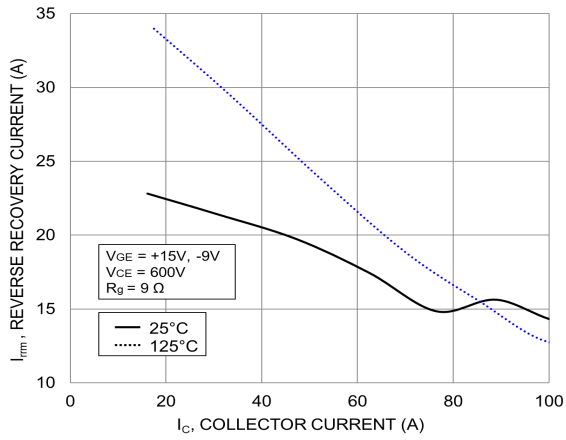

Figure 30. Typical Reverse Recovery Current vs. I_C

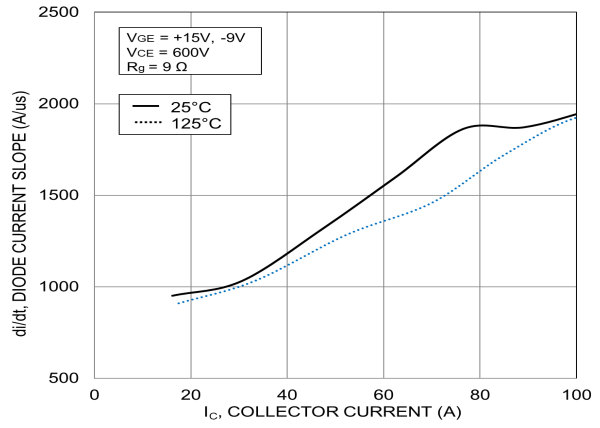

Figure 31. Typical di/dt vs. I_C

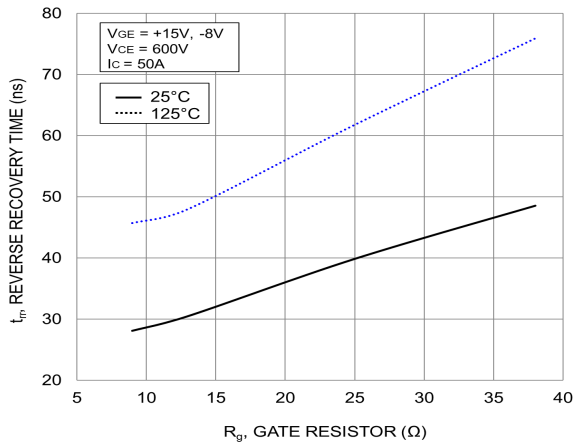

Figure 32. Typical Reverse Recovery Time vs. R_g

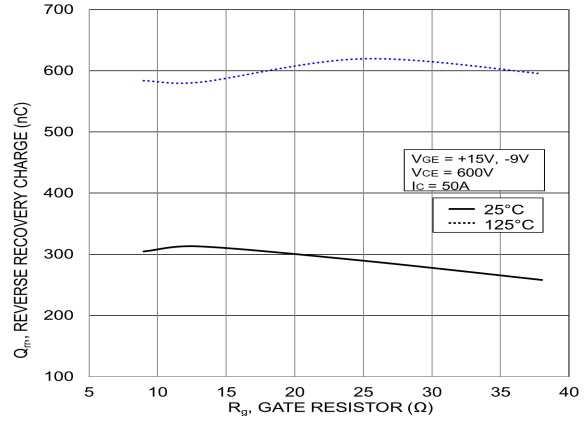

Figure 33. Typical Reverse Recovery Charge vs. R_g

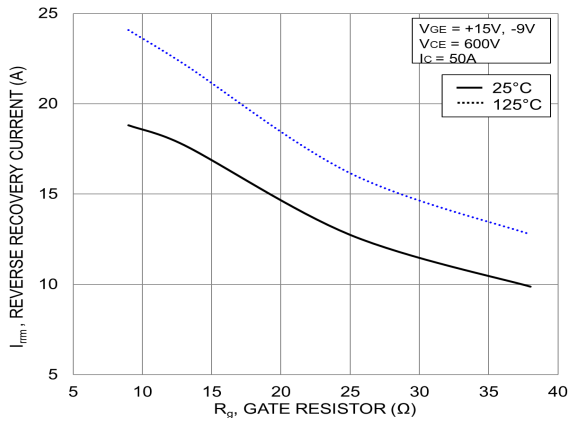

Figure 34. Typical Reverse Recovery Peak Current vs. R_g

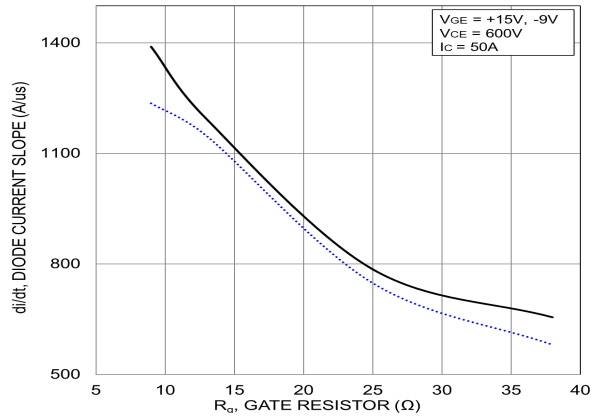
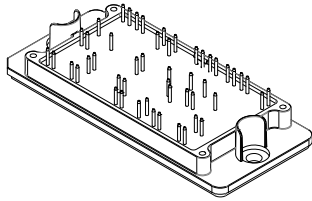

Figure 35. Typical di/dt vs. R_g

MECHANICAL CASE OUTLINE

PACKAGE DIMENSIONS



PIM56, 93x47 (SOLDER PIN)
CASE 180BK
ISSUE O

DATE 19 MAY 2022

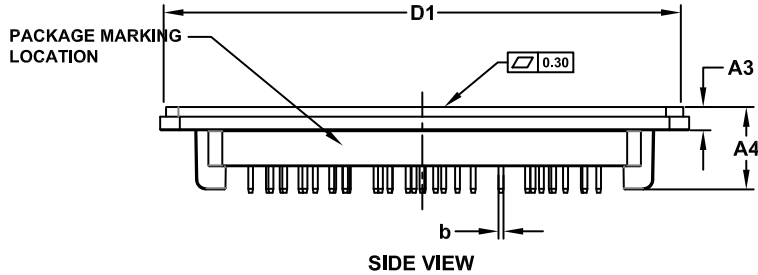

NOTES:

1. DIMENSIONING AND TOLERANCING PER ASME Y14.5M, 2009
2. CONTROLLING DIMENSION : MILLIMETERS
3. DIMENSIONS b AND b1 APPLY TO THE PLATED TERMINALS AND ARE MEASURED AT DIMENSION A1
4. PIN POSITION TOLERANCE IS $\pm 0.4\text{mm}$
5. PACKAGE MARKING IS LOCATED AS SHOWN ON THE SIDE OPPOSITE THE PACKAGE ORIENTATION FEATURES

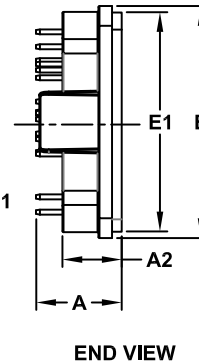
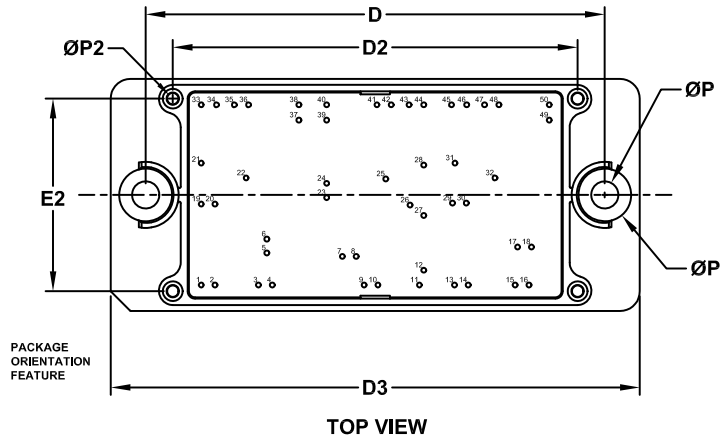

DIM	MILLIMETERS		
	MIN.	NOM.	MAX.
A	16.80	17.20	17.60
A2	11.70	12.00	12.30
A3	4.40	4.70	5.00
A4	16.40	16.70	17.00
b	0.95	1.00	1.05
D	92.90	93.00	93.10
D1	104.45	104.75	105.05
D2	81.80	82.00	82.20
D3	106.90	107.20	107.50
E	46.70	47.00	47.30
E1	44.10	44.40	44.70
E2	38.80	39.00	39.20
P	5.40	5.50	5.60
P1	10.60	10.70	10.80
P2	1.80	2.00	2.20

NOTE 4

Pin #	X	Y	Function	Pin #	X	Y	Function
1	0	0	BSC12	26	42.3	16.2	G21
2	2.8	0	BSC12	27	45.1	14.1	E21
3	11.6	0	BSC11	28	45.1	24.3	N2
4	14.4	0	BSC11	29	50.9	16.6	E31
5	13.3	6.5	BST1	30	53.7	16.6	G31
6	13.3	9.3	BST1	31	51.4	24.7	N3
7	28.6	5.8	BST2	32	59.5	21.7	C32
8	31.4	5.8	BST2	33	0	36.5	DC-1
9	33	0	BSC21	34	3.1	36.5	DC-1
10	35.8	0	BSC21	35	6.7	36.5	E12
11	44.2	0	BSC22	36	9.6	36.5	G12
12	45.1	3	BSC22	37	19.8	33.4	DC+1
13	51.3	0	BSC32	38	19.8	36.5	DC+1
14	54.1	0	BSC32	39	25.4	33.4	DC+2
15	63.6	0	BSC31	40	25.4	36.5	DC+2
16	66.4	0	BSC31	41	35.6	36.5	G22
17	64.1	7.7	BST3	42	38.5	36.5	E22
18	66.9	7.7	BST3	43	42.1	36.5	DC-2
19	0	16.4	E11	44	45.1	36.5	DC-2
20	2.8	16.4	G11	45	50.7	36.5	DC-3
21	0	24.7	N1	46	53.8	36.5	DC-3
22	9.1	21.7	C12	47	57.4	36.5	E32
23	25.4	17.7	TH2	48	60.3	36.5	G32
24	25.4	20.6	TH1	49	70.5	33.4	DC+3
25	37.4	21.5	C22	50	70.5	36.5	DC+3

DOCUMENT NUMBER:	98AON45176H	Electronic versions are uncontrolled except when accessed directly from the Document Repository. Printed versions are uncontrolled except when stamped "CONTROLLED COPY" in red.
DESCRIPTION:	PIM56, 93x47 (SOLDER PIN)	PAGE 1 OF 2

onsemi and onsemi are trademarks of Semiconductor Components Industries, LLC dba onsemi or its subsidiaries in the United States and/or other countries. onsemi reserves the right to make changes without further notice to any products herein. onsemi makes no warranty, representation or guarantee regarding the suitability of its products for any particular purpose, nor does onsemi assume any liability arising out of the application or use of any product or circuit, and specifically disclaims any and all liability, including without limitation special, consequential or incidental damages. onsemi does not convey any license under its patent rights nor the rights of others.

PIM56, 93x47 (SOLDER PIN)
CASE 180BK
ISSUE O

DATE 19 MAY 2022

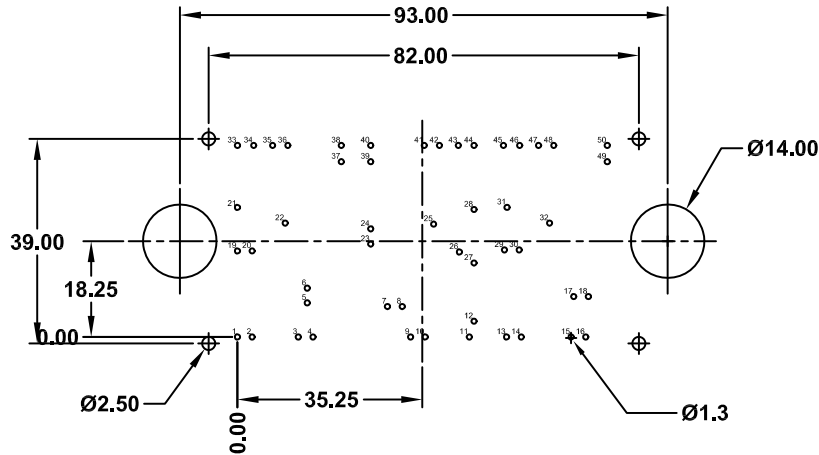

RECOMMENDED MOUNTING PATTERN

* For additional information on our Pb-Free strategy and soldering details, please download the ON Semiconductor Soldering and Mounting Techniques Reference Manual, SOLDERRM/D.

GENERIC MARKING DIAGRAM*

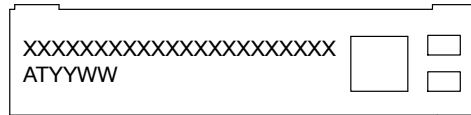

FRONTSIDE MARKING

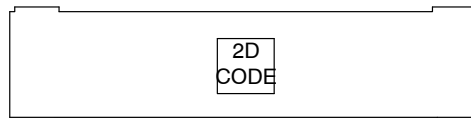

BACKSIDE MARKING

XXXXX = Specific Device Code
 AT = Assembly & Test Site Code
 YYWW = Year and Work Week Code

*This information is generic. Please refer to device data sheet for actual part marking. Pb-Free indicator, "G" or microdot "•", may or may not be present. Some products may not follow the Generic Marking.

DOCUMENT NUMBER:	98AON45176H	Electronic versions are uncontrolled except when accessed directly from the Document Repository. Printed versions are uncontrolled except when stamped "CONTROLLED COPY" in red.
DESCRIPTION:	PIM56, 93x47 (SOLDER PIN)	PAGE 2 OF 2

onsemi and ONSEMI are trademarks of Semiconductor Components Industries, LLC dba onsemi or its subsidiaries in the United States and/or other countries. onsemi reserves the right to make changes without further notice to any products herein. onsemi makes no warranty, representation or guarantee regarding the suitability of its products for any particular purpose, nor does onsemi assume any liability arising out of the application or use of any product or circuit, and specifically disclaims any and all liability, including without limitation special, consequential or incidental damages. onsemi does not convey any license under its patent rights nor the rights of others.

onsemi, **Onsemi**, and other names, marks, and brands are registered and/or common law trademarks of Semiconductor Components Industries, LLC dba "**onsemi**" or its affiliates and/or subsidiaries in the United States and/or other countries. **onsemi** owns the rights to a number of patents, trademarks, copyrights, trade secrets, and other intellectual property. A listing of **onsemi**'s product/patent coverage may be accessed at www.onsemi.com/site/pdf/Patent-Marking.pdf. **onsemi** reserves the right to make changes at any time to any products or information herein, without notice. The information herein is provided "as-is" and **onsemi** makes no warranty, representation or guarantee regarding the accuracy of the information, product features, availability, functionality, or suitability of its products for any particular purpose, nor does **onsemi** assume any liability arising out of the application or use of any product or circuit, and specifically disclaims any and all liability, including without limitation special, consequential or incidental damages. Buyer is responsible for its products and applications using **onsemi** products, including compliance with all laws, regulations and safety requirements or standards, regardless of any support or applications information provided by **onsemi**. "Typical" parameters which may be provided in **onsemi** data sheets and/or specifications can and do vary in different applications and actual performance may vary over time. All operating parameters, including "Typicals" must be validated for each customer application by customer's technical experts. **onsemi** does not convey any license under any of its intellectual property rights nor the rights of others. **onsemi** products are not designed, intended, or authorized for use as a critical component in life support systems or any FDA Class 3 medical devices or medical devices with a same or similar classification in a foreign jurisdiction or any devices intended for implantation in the human body. Should Buyer purchase or use **onsemi** products for any such unintended or unauthorized application, Buyer shall indemnify and hold **onsemi** and its officers, employees, subsidiaries, affiliates, and distributors harmless against all claims, costs, damages, and expenses, and reasonable attorney fees arising out of, directly or indirectly, any claim of personal injury or death associated with such unintended or unauthorized use, even if such claim alleges that **onsemi** was negligent regarding the design or manufacture of the part. **onsemi** is an Equal Opportunity/Affirmative Action Employer. This literature is subject to all applicable copyright laws and is not for resale in any manner.

ADDITIONAL INFORMATION

TECHNICAL PUBLICATIONS:

Technical Library: www.onsemi.com/design/resources/technical-documentation
onsemi Website: www.onsemi.com

ONLINE SUPPORT: www.onsemi.com/support

For additional information, please contact your local Sales Representative at www.onsemi.com/support/sales