



## Relais statique biphasé de puissance prêt à l'emploi Ready to use Double Power Solid State Relay

# SOB96366WF

(SOB963660 + WF151200)

**Output : 2 x 35A (see curve)**  
**24-600VAC**  
**Input : 10-30VDC**

- ❑ Relais statique biphasé synchrone monté sur dissipateur spécialement adapté aux charges résistives.  
*2 Leg Zero Cross Solid State Relay on Heatsink specially designed for resistive loads.*
- ❑ Sortie thyristors technologie TMS<sup>2</sup> (\*) permettant une longue durée de vie : **24 à 600VAC 35A**. Voir les courants thermiques page 3  
*Back to back thyristors on output with TMS<sup>2</sup> (\*) technology for a long lifetime expectancy: 24 to 600 Vac 35A. See thermal curve page 3*
- ❑ Entrées doubles avec LED de visualisation sur les 2 entrées de couleur verte. *Double input with green LED visualization on the inputs.*
- ❑ Protection IP20. / *IP20 protection flaps.*
- ❑ Construit en conformité aux normes EN60947-4-3 (IEC947-4-3) et EN60950/VDE0805 (Isolement renforcé) -UL-cUL pending  
*Designed in conformity with EN60947-4-3 (IEC947-4-3) and EN60950/VDE0805 (Reinforced Insulation) -UL-cUL pending*
- ❑ Différentes possibilités de connecteur de commande. Les relais sont livrés sans le connecteur de commande. Sélectionner ce connecteur pages 6 à 9.  
*Different possibilities for input connector. Input connector is not delivered with the SSR. Select input connector in pages 6 to 9.*
- ❑ Sur demande: Toute la gamme monophasé SO, biphasé SOB ou encore gradateurs SO4 est possible dans cette configuration de montage sur dissipateur.  
*On request: All the one pole SO range, two poles SOB range, phase angle controller SO4 are available with this heatsink configuration.*

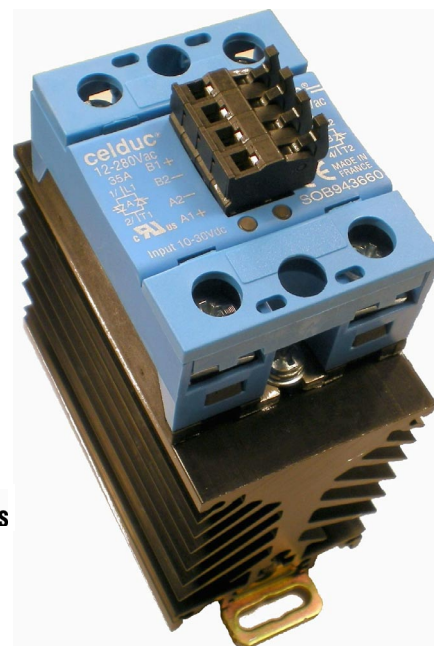

UL US

CE

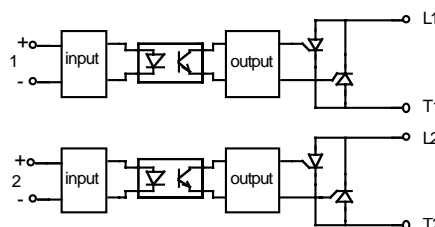

### Application typique/ Typical application

$I1 = I2 = I3 = 15A$

Power Load  
 $P = U \times I \times 1,732$

$P_{max} (400VRMS) = 10000 \text{ Watts}$

Réseau  
Triphasé  
400VAC

Three phase  
400VRMS  
Mains

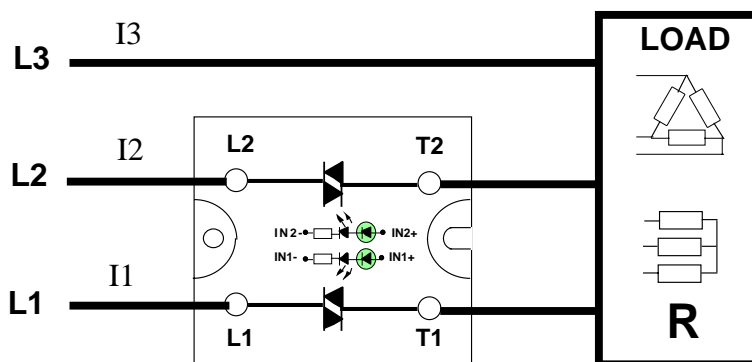

(\*) : Thermo Mechanical Stress Solution

*Proud to serve you*

**celduc®**  
r e l a i s

## Caractéristiques d'entrée / Control characteristics (at 25°C)

Paramètre / Parameter	Symbol	DC		
		Min	Typ	Max
Tension de commande / Control voltage	Uc	10		30
Courant de commande / Control current (@ Uc)	Ic	6		24
Tension de non fonctionnement / Release voltage	Uc off	2		
LED d'entrée / Input LED		verte / green		
Tension Inverse / Reverse voltage	Urv		32	
Tension de transil d'entrée / Clamping voltage (Transil)	Uclamp		36	
Immunité / Input immunity : EN61000-4-4			2kV	
Immunité / Input immunity : EN61000-4-5			2KV	

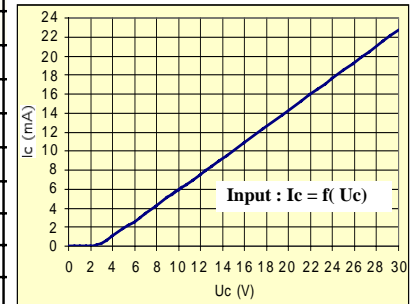

## Caractéristiques de sortie / Output characteristics (at 25°C)

Paramètre / Parameter	Conditions	Symbol	Min	Typ.	Max	Unit
Plage de tension utilisation / Operating voltage range		Ue	24	400	600	V rms
Tension de crête / Peak voltage		Up	1200			V
Niveau de synchronisme / Zero cross level		Usync			35	V
Tension minimum amorçage / Latching voltage	Ie nom	Ua			10	V
Courant nominal / nominal current (AC-51)		Ie AC-51		see thermal curve	35	A rms
Courant surcharge / Non repetitive overload current	tp=10ms (Fig. 3)	Itsm	400	500		A
Chute directe à l'état passant / On state voltage drop	@ 25°C	Vt			0,9	V
Résistance dynamique / On state dynamic resistance		rt			15	mΩ
Puissance dissipée (max) par phase / Output power dissipation (max value) by power		Pd	$0,9 \times 0,9 \times I_e + 0,014 \times I_e^2$			W
Résistance thermique jonction/semelle / Thermal resistance between junction to case		Rthj/c			0,6	K/W
Courant de fuite à l'état bloqué / Off state leakage current	@Ue typ, 50Hz	Ilk			1	mA
Courant minimum de charge / Minimum load current		Iemin	5			mA
Temps de fermeture / Turn on time	@Ue typ, 50Hz	ton max			10	ms
Temps d'ouverture / Turn off time	@Ue typ, 50Hz	toff max			10	ms
Fréquence utilisation / Operating frequency range	F mains	f	0,1	50-60	800	Hz
dv/dt à l'état bloqué / Off state dv/dt		dv/dt	500			V/μs
di/dt max / Maximum di/dt non repetitive		di/dt			50	A/μs
I <sub>2t</sub> (<10ms)		I <sup>2</sup> <sub>t</sub>	800	1250		A <sup>2</sup> s
Immunité / Conducted immunity level	IEC/EN61000-4-4 (bursts)		2kV criterion B			
Immunité / Conducted immunity level	IEC/EN61000-4-5 (surge)		2kV criterion B with external VDR			
Protection court-circuit / Short circuit protection	voir/see page 9	Example	Fuse FERRAZ gRC 25A/32A 14x51			

## Caractéristiques générales / General characteristics (at 25°C)

	Symbol		
Isolement entrée/sortie - Input to output insulation	Ui	4000	VRMS
Isolation sortie/ semelle - Output to case insulation	Ui	4000	VRMS
Résistance Isolement / Insulation resistance	Ri	1000 (@500VDC)	MΩ
Tenue aux tensions de chocs / Rated impulse voltage	Uimp	4000	V
Degré de protection / Protection level / CEI529		IP20	
Degré de pollution / Pollution degree	-	2	
Vibrations / Vibration withstand 10 -55 Hz according to CEI68	double amplitude	1,5	mm
Tenue aux chocs / Shocks withstand according to CEI68	-	30/50	g
Température de fonctionnement / Ambient temperature	-	-55 /+100	°C
Température de stockage / Storage temperature (no icing, no condensation)	-	-55/+125	°C
Humidité relative / Ambient humidity	HR	40 to 85	%
Poids / Weight		80	g
Conformité / Conformity		EN60947-4-3 (IEC947-4-3)	
Conformité / Conformity	pending	VDE0805/EN60950 UL/cUL	
plastique du boîtier / Housing Material		PA 6 UL94VO	
Semelle / Base plate		Aluminium, nickel-plated	



ISO 9001  
N° 1993/1106a

**celduc**<sup>®</sup>  
r e l a i s

www.celduc.com

Rue Ampère B.P. 4 42290 SORBIERS - FRANCE E-Mail : celduc-relais@celduc.com  
Fax +33 (0) 4 77 53 85 51 Service Commercial France Tél. : +33 (0) 4 77 53 90 20  
Sales Dept.For Europe Tel. : +33 (0) 4 77 53 90 21 Sales Dept. Asia : Tél. +33 (0) 4 77 53 90 19

**Courbes thermiques / Thermal specifications**

Les courbes son données avec des courants identiques dans les 2 voies  
 Curves are given with the same current inside the two legs

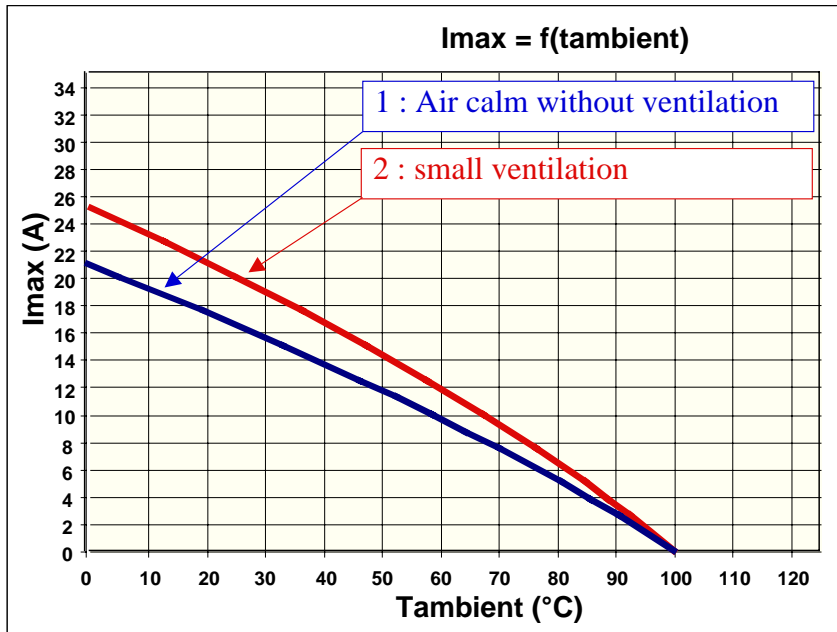

**Courants de surcharges / Overload currents**

**1 -Itsm non répétitif** sans tension réappliquée est donné pour la détermination des protections.

*No repetitive Itsm is given without voltage re-applied. This curve is used to define the protection (fuses).*

**2 -Itsm répétitif** est donné pour des surcharges de courant (Tj initiale=70°C).

Attention : la répétition de ces surcharges de courant diminue la durée de vie du relais.

*Repetitive Itsm is given for inrush current with initial Tj = 70°C. In normal operation, this curve mustn't be exceeded.*

*Be careful, the repetition of the surge current decreases the life expectancy of the SSR.*

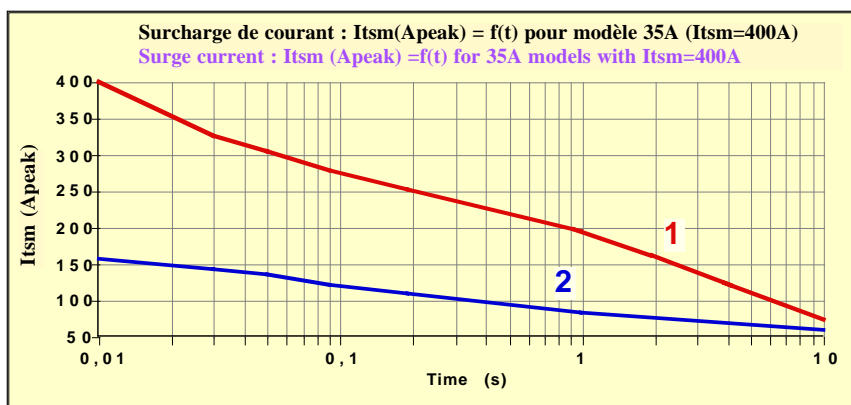

-> **Attention !** les relais à semi-conducteurs ne procurent pas d'isolation galvanique entre le réseau et la charge. Ils doivent être utilisés associés à un disjoncteur avec propriété de sectionnement ou similaire, afin d'assurer un sectionnement fiable en amont de la ligne dans l'hypothèse d'une défaillance et pour tous les cas où le relais doit être isolé du réseau (maintenance ; non utilisation sur une longue durée...).

-> **Warning !** semiconductor relays don't provide any galvanic insulation between the load and the mains. Always use in conjunction with an adapted circuit breaker with isolation feature or a similar device in order to ensure a reliable insulation in the event of wrong function and when the relay must be insulated from the mains (maintenance ; if not used for a long duration ...).



**Dimensions sans le connecteur de commande/  
Dimensions without control connector**

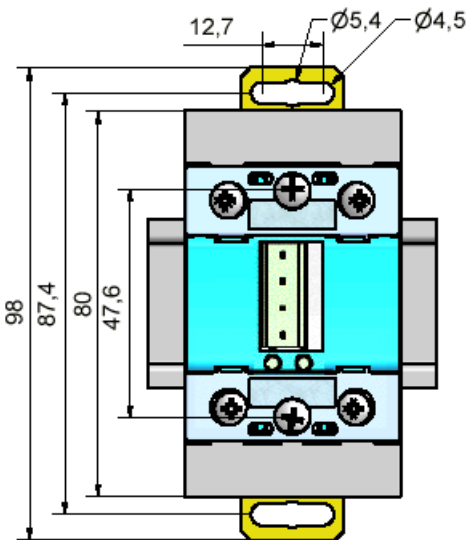
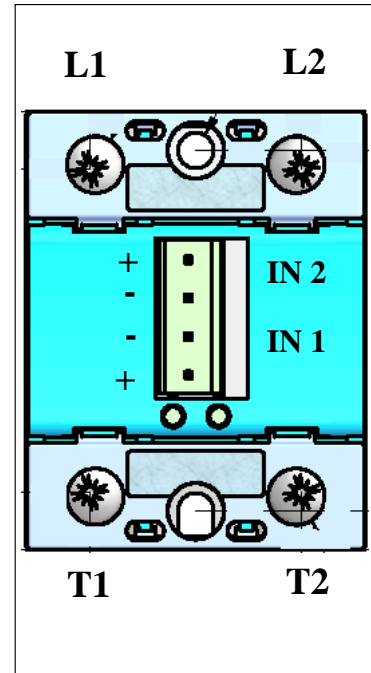
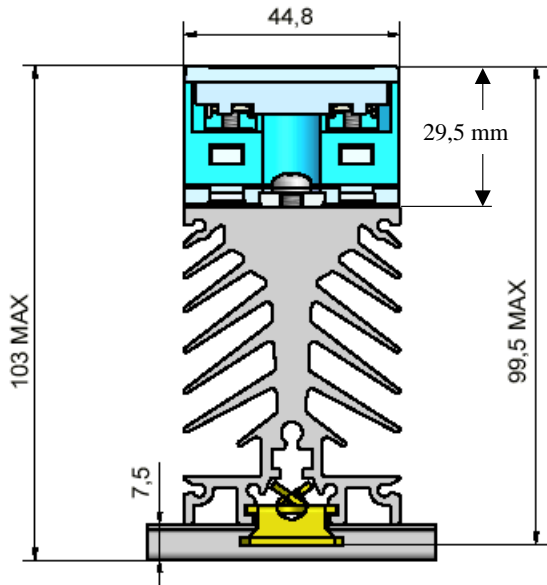

**H dépend du type de connecteur de commande.**  
Différent modèles possibles: voir page suivantes  
H max = 47mm

**H depends on the type of input connector**  
Different solutions are available : see following pages  
H max = 47mm

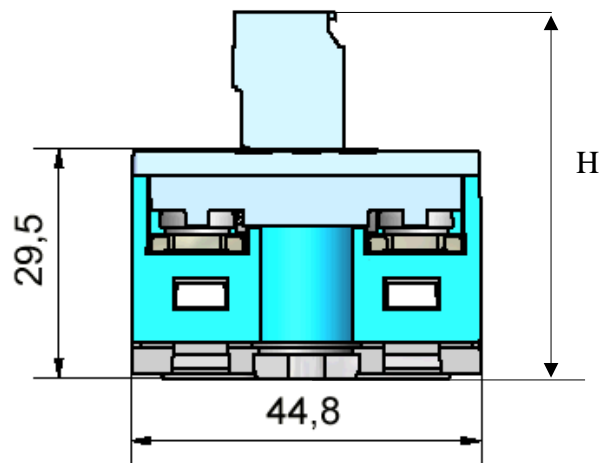

ISO 9001  
N° 1993/1106a

**celduc®**  
r e l a i s

[www.celduc.com](http://www.celduc.com)

Rue Ampère B.P. 4 42290 SORBIERS - FRANCE E-Mail : [celduc-relais@celduc.com](mailto:celduc-relais@celduc.com)  
Fax +33 (0) 4 77 53 85 51 Service Commercial France Tél. : +33 (0) 4 77 53 90 20  
Sales Dept.For Europe Tel. : +33 (0) 4 77 53 90 21 Sales Dept. Asia : Tél. +33 (0) 4 77 53 90 19



**Raccordement de puissance / Power connections**

Directement avec fils avec ou sans embouts/  
Direct connection with wires with or without ferrules

Avec cosses/  
With ring terminals

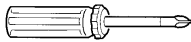
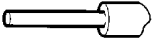
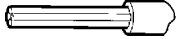
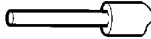

Nouvelles bornes avec rondelles freins  
New terminals with washers

okpac® Raccordement de puissance / Power wiring				Modèle de tournevis / Screwdriver type	Couple de serrage recommandé Recommended Torque
Nombre de fils / Number of wires					
1		2		 POZIDRIV 2	M5  N.m  2
Fil rigide (sans embout) SOLID (No ferrule)	Fil multibrins (avec embout) FINE STRANDED (With ferrule)	Fil rigide (sans embout) SOLID (No ferrule)	Fil multibrins (avec embout) FINE STRANDED (With ferrule)		
					
1,5 ... 10 mm <sup>2</sup> AWG16...AWG8	1,5 ... 6 mm <sup>2</sup> AWG16...AWG10	1,5 ... 10 mm <sup>2</sup> AWG16...AWG8	1,5 ... 6 mm <sup>2</sup> AWG16...AWG10		

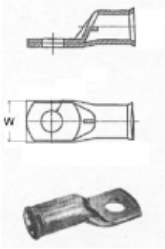





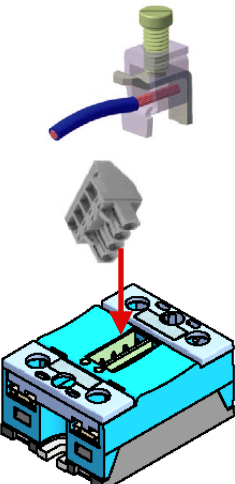

**Puissance avec cosses / Power with ring terminals.**  
**W max = 12,6mm**  
 16 mm<sup>2</sup> (AWG6)  
 25 mm<sup>2</sup> (AWG4)  
 35mm<sup>2</sup> (AWG2/AWG3)  
 50mm<sup>2</sup> (AWG0/AWG1)

Des cosses et kits d'adaptation peuvent être fournis : voir relais forte puissance et documentation connexion forte puissance/ Suitable ring terminals and special kit for high current can be delivered: see high power SSR and data-sheet for power connexion.

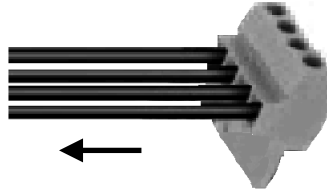
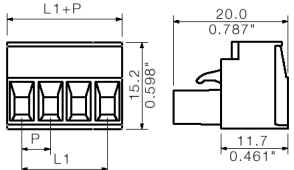

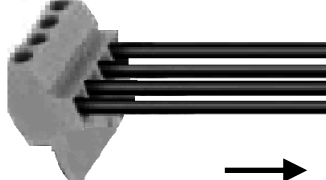
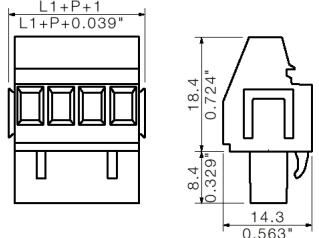
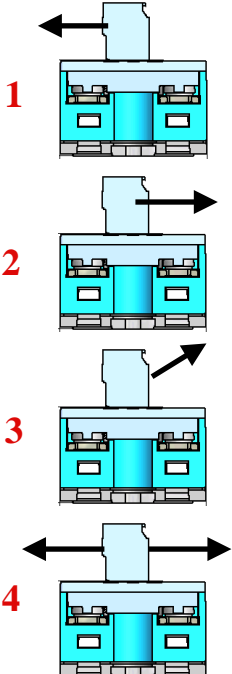
**Raccordement de commande par connecteur débrochable /**  
***Control connections by pluggable connector***

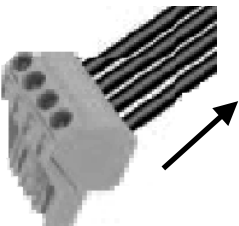
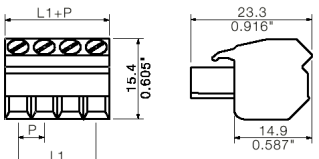
Différentes possibilités de connecteurs et de sortie/ Different possibilities of connectors and outputs

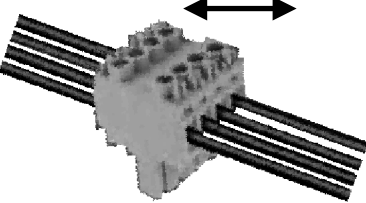
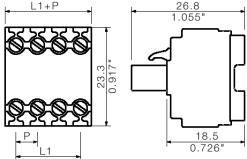
<p>Connecteur à vis Screw solution</p> 	<p><b>1</b> screw 270° Ref : <b>1Y042715</b> Weidmuller: BLZ5,08/4/270SN SW 1557510000</p>  <p>Single wire = 0,15...2,5mm<sup>2</sup> 26-12AWG Wire strip length = 7mm</p>  	<p><b>2</b> screw 90° Ref : <b>1Y040915</b> Weidmuller: BLZ5,08/4/90SN SW 1552910000</p>  <p>Single wire = 0,15...2,5mm<sup>2</sup> 26-12AWG Wire strip length = 7mm</p>  
	<p><b>3</b> Screw 45° Ref : <b>1Y042217</b> Weidmuller: BLZ5,08/4/225SN SW 1741890000</p>   <p>Single wire = 0,15...2,5mm<sup>2</sup> 26-12AWG Wire strip length = 8mm</p> 	<p><b>4</b> double Ref : <b>1Y041660</b> Weidmuller: BLDT5,08/4 SN SW 1660730000</p>   <p>Single wire = 0,15...2,5mm<sup>2</sup> 26-12AWG Wire strip length = 7mm</p> 



**Raccordement de commande par connecteur débrochable /**  
***Control connections by pluggable connector***

Différentes possibilités de connecteurs et de sortie/ Different possibilities of connectors and outputs

<p>Solution ressort Spring solutions</p> <p>5</p> <p>6</p> <p>7</p> <p>8</p> <p>no tool</p>	<p><b>5 180°</b></p> <p>Ref : <b><u>1Y041817</u></b></p> <p>Weidmuller: BLZF5,08/4/180 SW 1707710000</p> <p>Single wire = 0,15...2,5mm<sup>2</sup> 26-12AWG Wire strip length = 10mm</p> <p>L1+P</p> <p>25.1 0.988"</p> <p>16.75 0.660"</p> <p>0.602"</p> <p>0.563"</p>	<p><b>6 270°</b></p> <p>Ref : <b><u>1Y042716</u></b></p> <p>Weidmuller: BLZF5,08/4/270 SW 1672190000</p> <p>Single wire = 0,15...2,5mm<sup>2</sup> 26-12AWG Wire strip length = 10mm</p> <p>L1+P+1.95 L1+P+0.078"</p> <p>14.3 0.563"</p> <p>25.1 0.988"</p> <p>16.75 0.660"</p> <p>L1</p>	<p><b>7 90°</b></p> <p>Ref : <b><u>1Y040916</u></b></p> <p>Weidmuller: BLZF5,08/4/90 SW 1671040000</p> <p>Single wire = 0,15...2,5mm<sup>2</sup> 26-12AWG Wire strip length = 10mm</p> <p>L1+P</p> <p>14.3 0.563"</p> <p>25.1 0.988"</p> <p>16.75 0.660"</p> <p>L1</p>
<p><b>8 Spring solutions with no tool</b></p> <p>Ref : <b><u>1Y044604</u></b></p> <p>RIA: ASO04604.02</p> <p>Put and remove a wire</p> <p>1.</p> <p>2.</p> <p>Wire diameter = 0,3-1,3mm 28-16 AWG</p> <p>Wire strip length = 4mm</p> <p>20.7</p> <p>18.15</p> <p>17</p> <p>3.8</p> <p>15.5</p> <p>2.5</p> <p>2.2</p> <p>L</p> <p>5.08</p>			

**Raccordement de commande par connecteur débrochable /**  
***Control connections by pluggable connector***

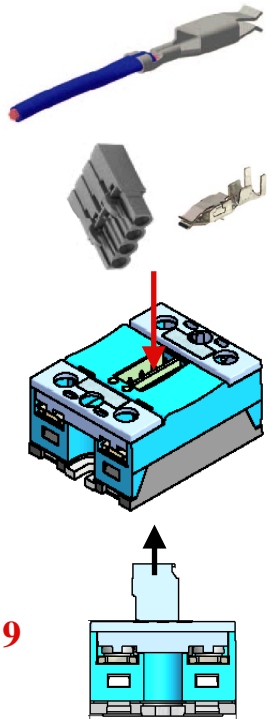
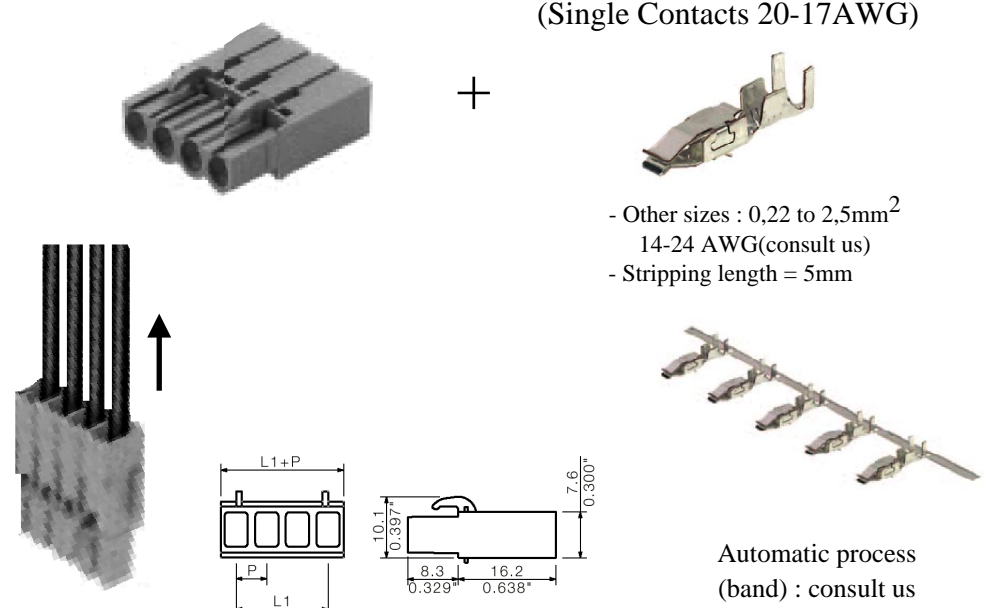
Différentes possibilités de connecteurs et de sortie/ Different possibilities of connectors and outputs

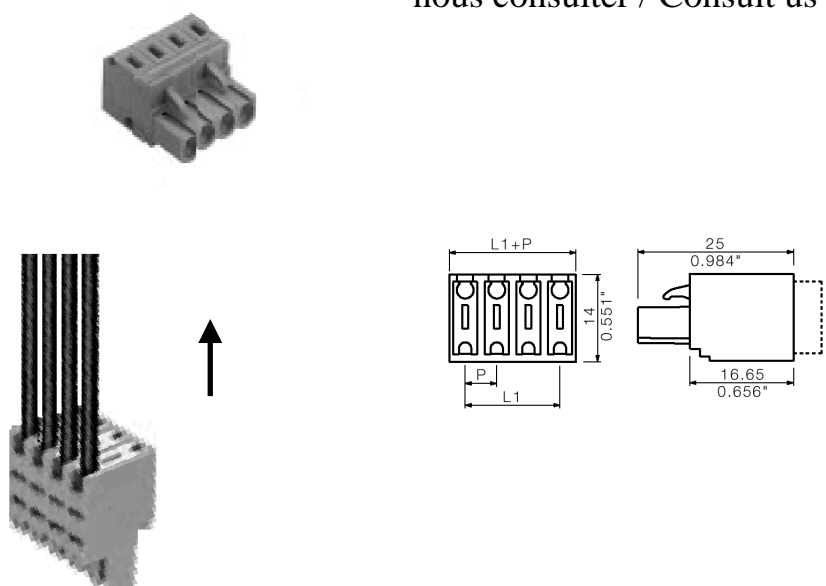
<p>Cosses Crimp solutions</p>  <p>9</p>	<p>9 Cosses / Crimp solutions</p> <p>Ref : <b>1Y041711</b> Weidmuller: BLC5,08/4/180R SW 1711980000</p> <p>Ref : <b>1Y011567</b> Weidmuller: CTS FemBLAC 0,5/1mm<sup>2</sup> 1267060000 (Single Contacts 20-17AWG)</p> <p>- Other sizes : 0,22 to 2,5mm<sup>2</sup> 14-24 AWG(consult us) - Stripping length = 5mm</p> <p>Automatic process (band) : consult us</p>  <p>Dimensions: L1+P, P, L1, 10.1, 10.397, 8.3, 16.2, 0.329, 0.638, 7.6, 0.300</p>
<p>Insulation Displacement Connection</p>  <p>10</p>	<p>10 nous consulter / Consult us</p>  <p>Dimensions: L1+P, P, L1, 7.4, 0.651, 25, 0.984, 16.65, 0.656</p>



### Application typiques / Typical LOADS

- > Les produit SOB9 sont définis principalement pour charge résistive AC-51 (chauffage).  
*SOB9 products are specially designed for AC-51 resistive load (heating).*

### Protection /Protection :

- > La protection d'un relais statique contre les court-circuits de la charge peut être faite par fusibles rapides avec des  $I^2t = 1/2 I^2t$  du relais . Un test en laboratoire a été effectué sur les fusibles de marque FERRAZ.  
Une protection par MCB ( disjoncteurs modulaires miniatures) est aussi possible.

Voir notre note application ( protection SSR) et utiliser des relais avec  $I^2t > 5000A^2s$

*To protect the SSR against a short-circuit of the load , use a fuse with a  $I^2t$  value = 1/2  $I^2t$  value specified page 2.  
A test has been made with FERRAZ fuses .*

*It is possible to protect SSR by MCB ( miniature circuit breaker).*

*In this case, see application note ( SSR protection) and use a SSR with high  $I^2t$  value (5000A<sup>2</sup>s minimum).*

### EMC :

- > **Immunité :** Nous spécifions dans nos notices le niveau d'immunité de nos produits selon les normes essentielles pour ce type de produit, c'est à dire EN61000-4-4 &5.

#### Immunity :

*We give in our data-sheets the immunity level of our SSRs according to the main standards for these products: EN61000-4-4 &5.*

- > **Emission:** Nos relais statiques sont principalement conçus et conformes pour la classe d'appareils A (Industrie).

L'utilisation du produit dans des environnements domestiques peut amener l'utilisateur à employer des moyens d'atténuation supplémentaires. En effet, les relais statiques sont des dispositifs complexes qui doivent être interconnectés avec d'autres matériels (charges, cables, etc) pour former un système. Etant donné que les autres matériels ou interconnexions ne sont pas de la responsabilité de **celduc**®, il est de la responsabilité du réalisateur du système de s'assurer que les systèmes contenant des relais statiques satisfont aux prescriptions de toutes les règles et règlements applicables au niveau des systèmes.

Consulter **celduc**® qui peut vous conseiller ou réaliser des essais dans son laboratoire sur votre application.

**Emission: celduc**® SSRs are mainly designed in compliance with standards for class A equipment (Industry).

Use of this product in domestic environments may cause radio interference. In this case the user may be required to employ additional devices to reduce noise. SSRs are complex devices that must be interconnected with other equipment (loads, cables, etc.) to form a system. Because the other equipment or the interconnections may not be under the control of **celduc**®, it shall be the responsibility of the system integrator to ensure that systems containing SSRs comply with the requirement of any rules and regulations applicable at the system level.

Consult **celduc**® for advices. Tests can be preformed in our laboratory.



ISO 9001  
N° 1993/1106a

**celduc**®  
r e l a i s

[www.celduc.com](http://www.celduc.com)

Rue Ampère B.P. 4 42290 SORBIERS - FRANCE E-Mail : [celduc-relais@celduc.com](mailto:celduc-relais@celduc.com)  
Fax +33 (0) 4 77 53 85 51 Service Commercial France Tél. : +33 (0) 4 77 53 90 20  
Sales Dept.For Europe Tel. : +33 (0) 4 77 53 90 21 Sales Dept. Asia : Tél. +33 (0) 4 77 53 90 19