



## Relais statique biphasé de puissance Double Power Solid State Relay 2 controls

# SOB967660

- ❑ Relais statique biphasé synchrone spécialement adapté aux charges résistives.  
*2 Leg Zero Cross Solid State Relay specially designed for resistive loads.*
- ❑ Sortie thyristors technologie TMS<sup>2</sup> (\*\*) permettant une longue durée de vie : **24 à 600VAC 75A(\*)**  
*Back to back thyristors on output with TMS<sup>2</sup> (\*\*) technology for a long lifetime expectancy : 24 to 600 Vac 75A(\*)*
- ❑ Entrée double avec LED de visualisation de couleur verte sur chaque entrée.  
*2 inputs with green LED visualization for each input.*
- ❑ Protection IP20.  
*IP20 protection flaps ( blue color).*
- ❑ Construit en conformité aux normes EN60947-4-3 (CEI60947-4-3), CEI62314 et EN60950/VDE0805 (Isolement renforcé) -UL-cUL  
*Designed in conformity with EN60947-4-3 (IEC60947-4-3), IEC62314 and EN60950/VDE0805 (Reinforced Insulation) -UL-cUL*
- ❑ Différentes possibilités de connecteur de commande.  
Les relais sont livrés sans le connecteur de commande.  
Sélectionner ce connecteur pages 6 à 9.  
*Different possibilities for input connector.  
Input connector is not delivered with the SSR.  
Select input connector in pages 6 to 9.*

(\*) Produit à utiliser pour son fort  $I^2t$ , courant permanent limité à 50A /

*Product to be used for its high  $I^2t$ , permanent current limited to 50A*

(\*\*) TMS<sup>2</sup> = Thermo-Mechanical Stress Solution

*Caractéristiques d'entrée / Control characteristics (at 25°C)*

Paramètre / Parameter	Symbol	DC		
		Min	Typ	Max
Tension de commande / Control voltage	Uc	10		30
Courant de commande / Control current (@ Uc)	Ic	6		24
Tension de non fonctionnement / Release voltage	Uc off	2		
LED d'entrée / Input LED		verte / green		
Tension Inverse / Reverse voltage	Urv		32	
Immunité / Input immunity : EN61000-4-4			2kV	
Immunité / Input immunity : EN61000-4-5			2KV	

**Sortie / Output :**  
**2x75A(\*)/24-600Vac**  
**Entrées / Inputs :**  
**10-30Vdc**

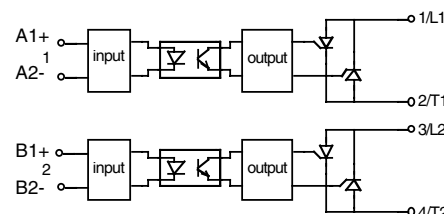

**Entrées / Inputs : Ic = f( Uc)**

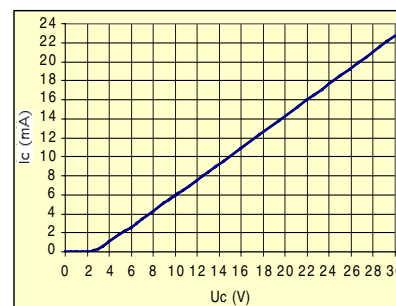

*Proud to serve you*

# celduc®

r e l a i s

**Caractéristiques de sortie / Output characteristics (at 25°C)**

Paramètre / Parameter	Conditions	Symbol	Min	Typ.	Max	Unit
Plage de tension utilisation / Operating voltage range		Ue	24	400	600	V rms
Tension de crête / Peak voltage		Up	1200			V
Niveau de synchronisme / Zero cross level		U <sub>sync</sub>			35	V
Tension minimum amorçage / Latching voltage	Ie nom	Ua			10	V
Calibre des thyristors / Thyristor current rating				75	90	A rms
Courant nominal / nominal current	AC-51 / LC-A	Ie		<b>50</b>	<b>60</b>	A rms
Courant surcharge / Non repetitive overload current	tp=10ms (Fig. 3)	I <sub>tsm</sub>	1000	1200		A
Chute directe à l'état passant / On state voltage drop	@ 25°C	V <sub>t</sub>			0,9	V
Résistance dynamique / On state dynamic resistance		r <sub>t</sub>			4,5	mΩ
Puissance dissipée (max) par élément de puissance/ Output power dissipation (max value) per power element		P <sub>d</sub>	0,9x0,9xIe + 0,0045xIe <sup>2</sup>			W
Résistance thermique jonction/semelle Thermal resistance between junction to case		R <sub>thj/c</sub>			0,4	K/W
Courant de fuite à l'état bloqué / Off state leakage current	@Ue typ, 50Hz	I <sub>lk</sub>			1	mA
Courant minimum de charge / Minimum load current		I <sub>emin</sub>	5			mA
Temps de fermeture / Turn on time	@Ue typ, 50Hz	t <sub>on max</sub>			10	ms
Temps d'ouverture / Turn off time	@Ue typ, 50Hz	t <sub>off max</sub>			10	ms
Fréquence utilisation / Operating frequency range	F mains	f	0,1	50-60	800	Hz
dv/dt à l'état bloqué / Off state dv/dt		dv/dt	500			V/μs
di/dt max non répétitif / Maximum di/dt non repetitive		di/dt			50	A/μs
I <sup>2</sup> t (Limite de fusion) / I <sup>2</sup> t (Melting limit)	<10ms	I <sup>2</sup> t	5000	7200		A <sup>2</sup> s
Immunité conduite / Conducted immunity level	IEC/EN61000-4-4 (bursts)		2kV criterion B			
Immunité conduite / Conducted immunity level	IEC/EN61000-4-5 (surge)		2kV criterion B with external VDR			
Protection court-circuit / Short circuit protection	voir/see page 9	Example	Fuse FERRAZ gRC 25A/32A/50A 14x51			

Caractéristiques générales / General characteristics (at 25°C)	Symbol		
Isolement entrée/sortie - Input to output insulation	U <sub>i</sub>	4000	Vrms
Isolation sortie/ semelle - Output to case insulation	U <sub>i</sub>	4000	Vrms
Résistance Isolement / Insulation resistance	R <sub>i</sub>	1000 (@500VDC)	MΩ
Tenue aux tensions de chocs / Rated impulse voltage	U <sub>imp</sub>	4000	V
Degré de protection / Protection level	CEI/IEC60529	IP20	
Degré de pollution / Pollution degree	-	2	
Tenue aux vibrations / Vibration withstand	CEI/IEC60068 double amplitude 10-55Hz	1,5	mm
Tenue aux chocs / Shocks withstand	CEI/IEC60068	30/50	g
Température ambiante de fonctionnement (sans givre ni condensation) / Ambient operating temperature (no icing, no condensation)	-	-40 /+100	°C
Température de stockage / Storage temperature (no icing, no condensation)		-40/+125	°C
Humidité relative / Relative humidity	HR	40 to 85	%
Altitude maximale / Max. altitude		2000	m
Poids / Weight		80	g
Conformité / Conformity		EN60947-4-3 (IEC60947-4-3)	
Conformité / Conformity		CEI62314 (IEC62314)	
Conformité / Conformity		VDE0805/EN60950 UL/cUL	
Matière du boîtier / Housing Material		PA 6 UL94VO	
Semelle / Base plate		Aluminium, nickel-plated	

## Courbes thermiques / Thermal specifications

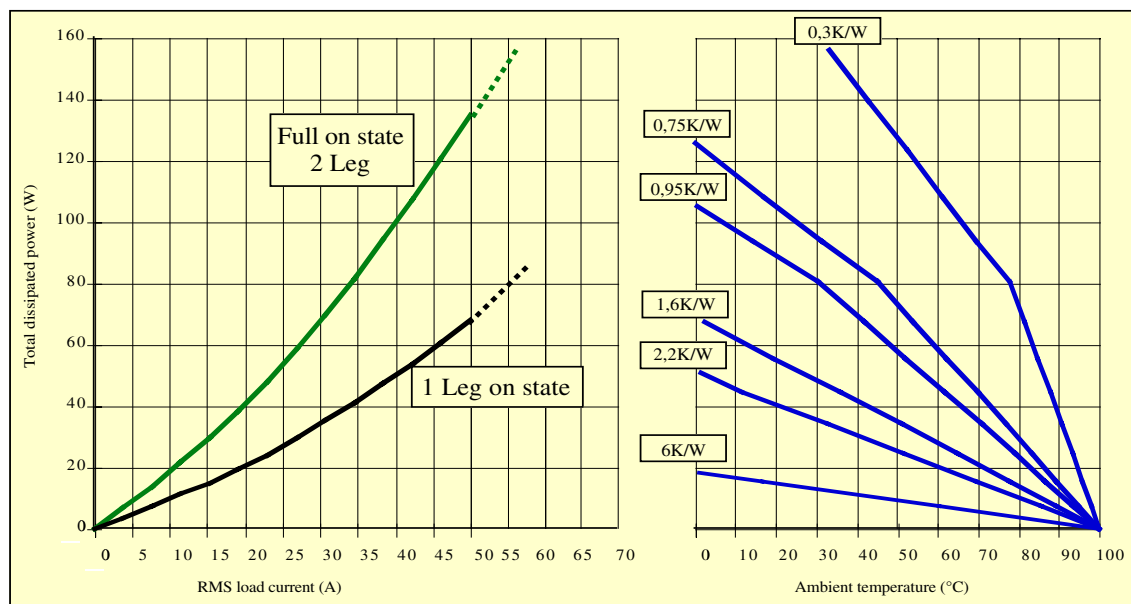

## Courants de surcharges / Overload currents

**1 -Itsm non répétitif** sans tension réappliquée est donné pour la détermination des protections.

*Non repetitive Itsm is given without voltage reapplied. This curve is used to define the protection (fuses).*

**2 -Itsm répétitif** est donné pour des surcharges de courant ( $T_j$  initiale=70°C).

Attention : la répétition de ces surcharges de courant diminue la durée de vie du relais.

*Repetitive Itsm is given for inrush current with initial  $T_j = 70^\circ\text{C}$ . In normal operation, this curve must not be exceeded.*

*Be careful, the repetition of the surge current decreases the life time expectancy of the SSR.*

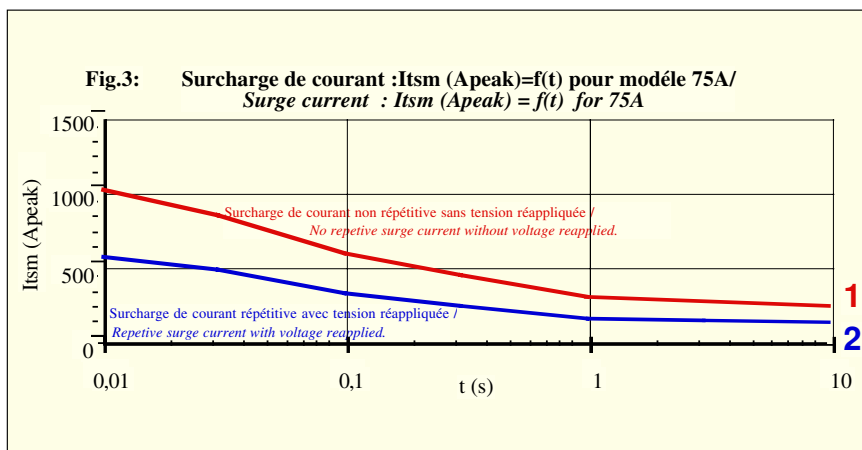

-> **Attention !** les relais à semi-conducteurs ne procurent pas d'isolation galvanique entre le réseau et la charge. Ils doivent être utilisés associés à un disjoncteur avec propriété de sectionnement ou similaire, afin d'assurer un sectionnement fiable en amont de la ligne dans l'hypothèse d'une défaillance et pour tous les cas où le relais doit être isolé du réseau (maintenance ; non utilisation sur une longue durée...).

-> **Warning !** semiconductor relays do not provide any galvanic insulation between the load and the mains. Always use in conjunction with an adapted circuit breaker with isolation feature or a similar device in order to ensure a reliable insulation in the event of wrong function and when the relay must be insulated from the mains (maintenance ; if not used for a long duration ...).

Dimensions sans le connecteur de commande/  
*Dimensions without control connector*

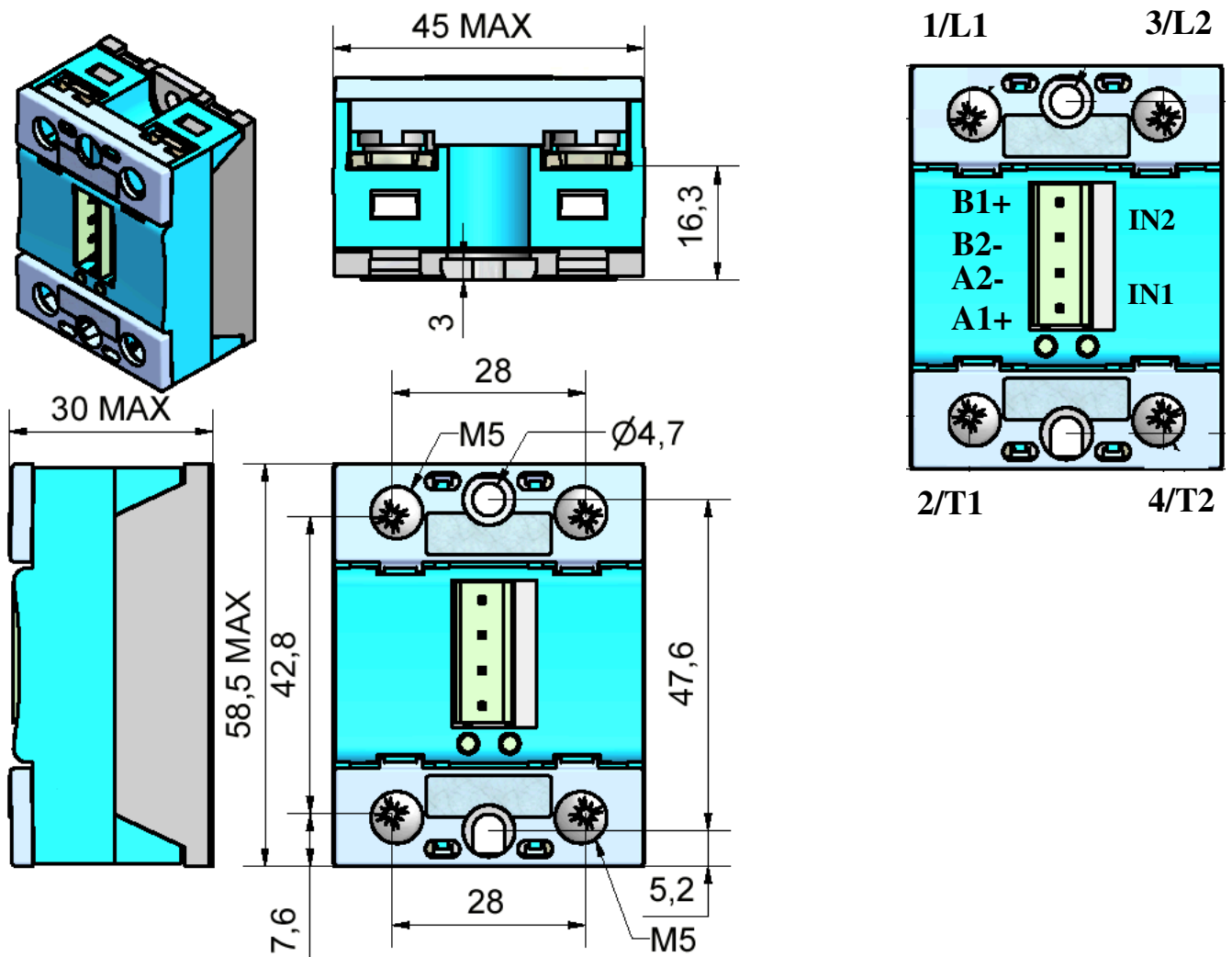

**H dépend du type de connecteur de commande.**

Différent modèles possibles: voir page suivantes

H max = 47mm

*H depends on the type of input connector*

*Different solutions are available: see following pages*

*H max = 47mm*

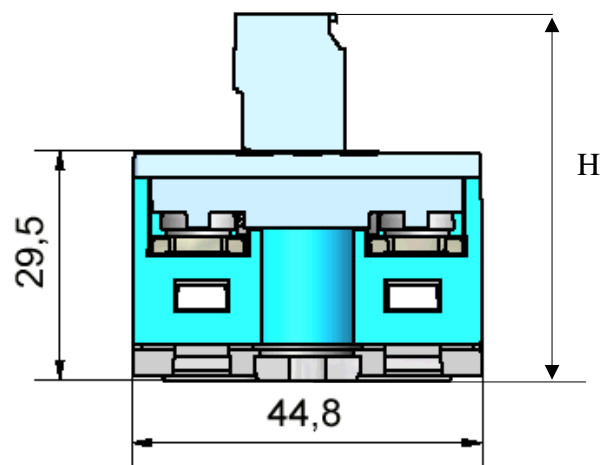





**Raccordement de puissance / Power connections**

Directement avec fils avec ou sans embouts/  
Direct connection with wires with or without ferrules

Avec cosses/  
With ring terminals

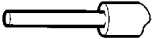

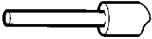
Nouvelles bornes avec rondelles freins  
New terminals with blocking washers

okpac® Raccordement de puissance / Power wiring				Modèle de tournevis / Type of screwdriver	Couple de serrage recommandé Recommended Torque
Nombre de fils / Number of wires					
1		2		 POZIDRIV 2	M5  N.m  2
Fil rigide (sans embout) <i>SOLID</i> (No ferrule)	Fil multibrins (avec embout) <i>FINE STRANDED</i> (With ferrule)	Fil rigide (sans embout) <i>SOLID</i> (No ferrule)	Fil multibrins (avec embout) <i>FINE STRANDED</i> (With ferrule)		
 1,5 ... 10 mm <sup>2</sup> <i>AWG16...AWG8</i>	 1,5 ... 6 mm <sup>2</sup> <i>AWG16...AWG10</i>	 1,5 ... 10 mm <sup>2</sup> <i>AWG16...AWG8</i>	 1,5 ... 6 mm <sup>2</sup> <i>AWG16...AWG10</i>		

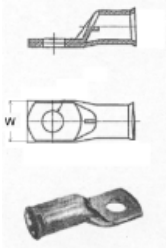
**Puissance avec cosses / Power with ring terminals.**  
**W max = 12,6mm**  
 16 mm<sup>2</sup> (AWG6)  
 25 mm<sup>2</sup> (AWG4)  
 35mm<sup>2</sup> (AWG2 /AWG3)  
 50mm<sup>2</sup> (AWG0 /AWG1)

Des cosses et kits d'adaptation peuvent être fournis : voir relais forte puissance et documentation connexion forte puissance/ Suitable ring terminals and special kit for high current can be delivered: see high power SSR and data-sheet for power connection.









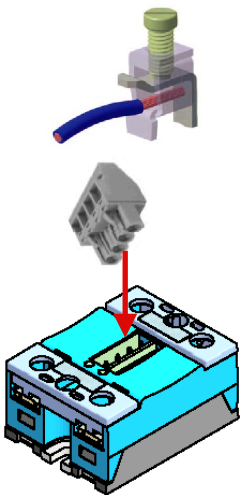

**celduc®**  
relais

www.celduc.com

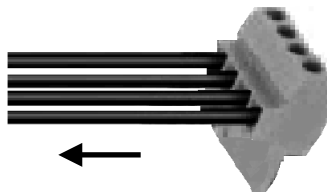
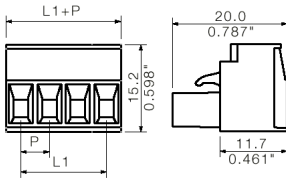
5 Rue Ampère B.P. 3004 42290 SOBRIERS - FRANCE E-Mail : celduc-relais@celduc.com  
 Fax +33 (0) 4 77 53 85 51 Service Commercial France Tél. : +33 (0) 4 77 53 90 20  
 Sales Dept.For Europe Tel. : +33 (0) 4 77 53 90 21 Sales Dept. Asia : Tél. +33 (0) 4 77 53 90 19

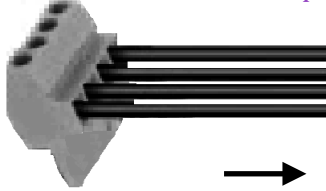
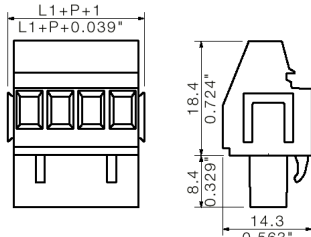
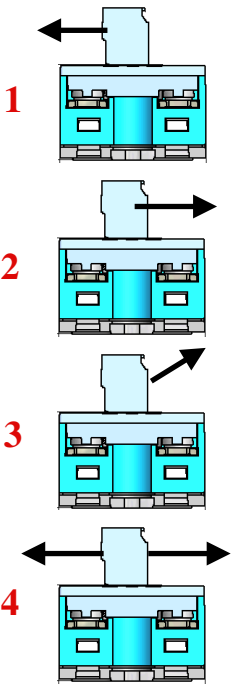

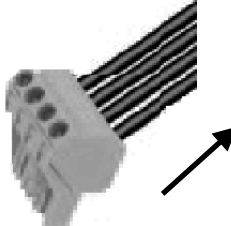
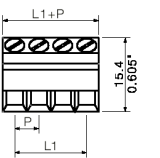

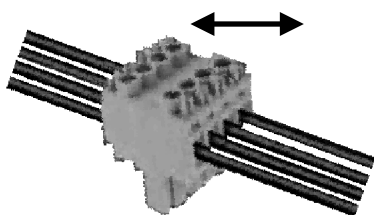
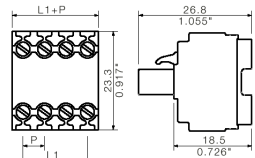

**Raccordement de commande par connecteur débrochable /**  
***Control connections by pluggable connector***

Différentes possibilités de connecteurs et de sortie/ *Different possibilities of connectors and outputs*

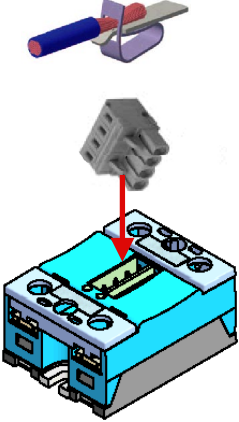
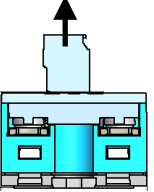
<p>Connecteur à vis <i>Screw solution</i></p> 	<p><b>1 vis / screw 270°</b>                  Ref : <b>1Y022715</b>                  Weidmuller: BLZ5,08/2/270SN SW</p>  <p>1 fil / <i>Single wire</i> = 0,15...2,5mm<sup>2</sup> (26-12AWG)                  Dénudage / <i>Wire strip length</i> = 7mm</p>  	<p><b>2 vis / screw 90°</b>                  Ref : <b>1Y020915</b>                  Weidmuller: BLZ5,08/2/90SN SW</p>  <p>1 fil / <i>Single wire</i> = 0,15...2,5mm<sup>2</sup> (26-12AWG)                  Dénudage / <i>Wire strip length</i> = 7mm</p>  
	<p><b>3 vis / screw 45°</b>                  Ref : <b>1Y022217</b>                  Weidmuller: BLZ5,08/2/225SN SW</p>   <p>1 fil / <i>Single wire</i> = 0,15...2,5mm<sup>2</sup> (26-12AWG)                  Dénudage / <i>Wire strip length</i> = 8mm</p> 	<p><b>4 double</b>                  Ref : <b>1Y021660</b>                  Weidmuller: BLDT5,08/2 SN SW</p>   <p>1 fil / <i>Single wire</i> = 0,15...2,5mm<sup>2</sup> (26-12AWG)                  Dénudage / <i>Wire strip length</i> = 7mm</p> 

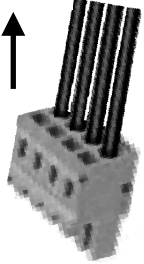
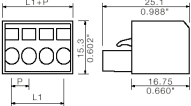
**Raccordement de commande par connecteur débrochable /**  
***Control connections by pluggable connector***

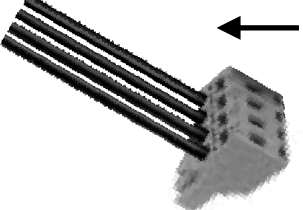
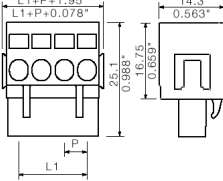
Différentes possibilités de connecteurs et de sortie/ *Different possibilities of connectors and outputs*

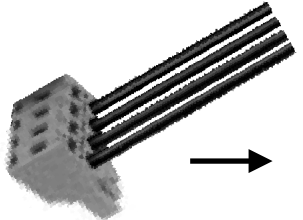
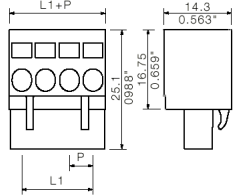
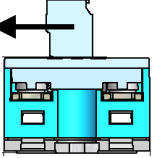
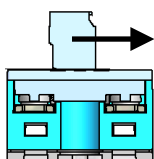
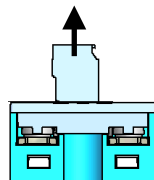
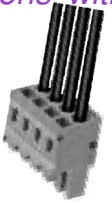
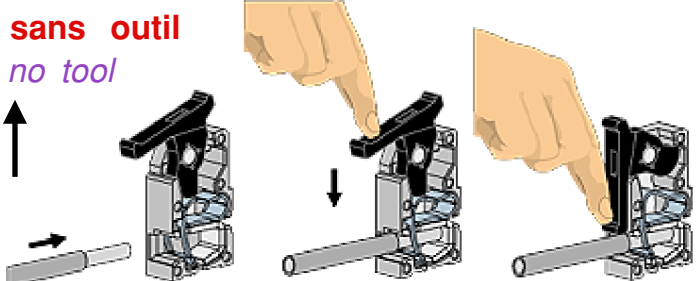
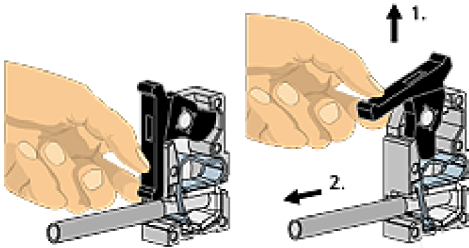
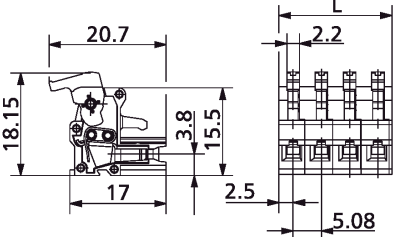
<p>Solution ressort <i>Spring solutions</i></p>  <p>5</p> 	<p><b>5</b>      <b>180°</b>                  Ref : <b>1Y021817</b>                  Weidmuller:                  BLZF5,08/2/180 SW</p> <p>1 fil / <i>Single wire</i>=                  0,15...2,5mm<sup>2</sup>                  (26-12AWG)                  Dénudage /<i>Wire strip length</i>=10mm</p>   	<p><b>6</b>      <b>270°</b>                  Ref : <b>1Y022716</b>                  Weidmuller:                  BLZF5,08/2/270 SW</p> <p>1 fil / <i>Single wire</i>=                  0,15...2,5mm<sup>2</sup>                  (26-12AWG)                  Dénudage /<i>Wire strip length</i>=10mm</p>   	<p><b>7</b>      <b>90°</b>                  Ref : <b>1Y020916</b>                  Weidmuller:                  BLZF5,08/2/90 SW</p> <p>1 fil / <i>Single wire</i>=                  0,15...2,5mm<sup>2</sup>                  (26-12AWG)                  Dénudage /<i>Wire strip length</i>=10mm</p>   
<p>6</p>  <p>7</p>  <p>8</p>  <p>Sans outil / <i>no tool</i></p>	<p><b>8 Solution à ressort sans outil</b>  <i>Spring solutions with no tool</i></p> <p>Ref : <b>1Y024604</b>                  RIA:                  ASO02604.02</p>   <p>Insérer et retirer un fil / <i>Put and remove a wire</i></p>   <p>1 fil diamètre/ <i>Single wire diameter</i>=                  0,3...1,3mm                  (28-16AWG)                  Dénudage /<i>Wire strip length</i>=4mm</p>		

**Raccordement de commande par connecteur débrochable /**  
***Control connections by pluggable connector***

Différentes possibilités de connecteurs et de sortie/ *Different possibilities of connectors and outputs*

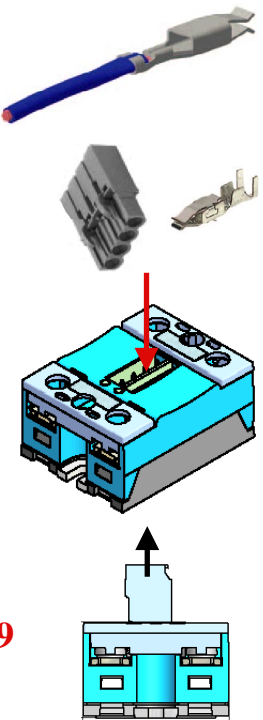
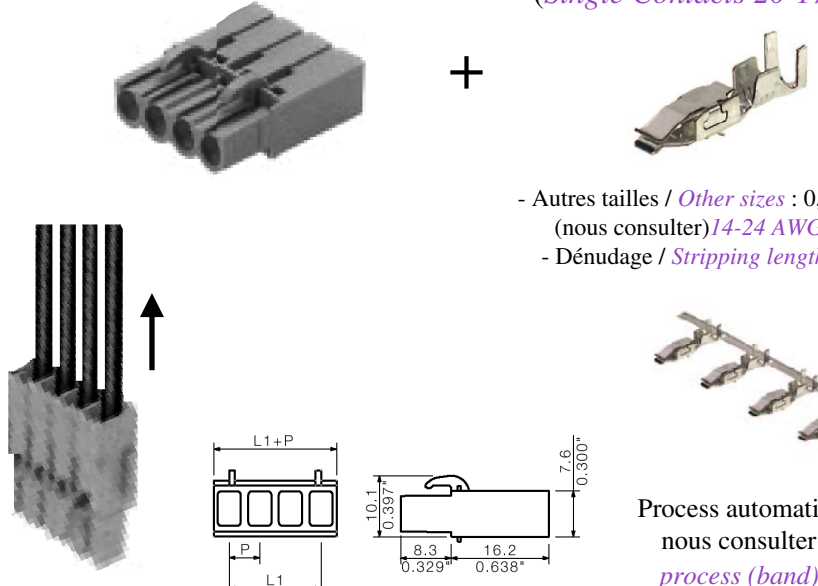
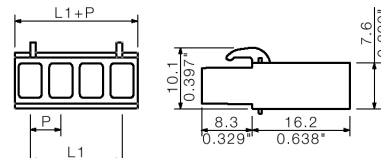
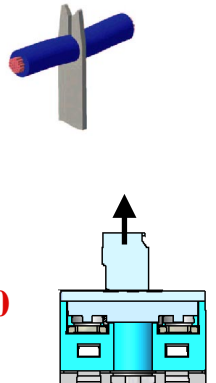
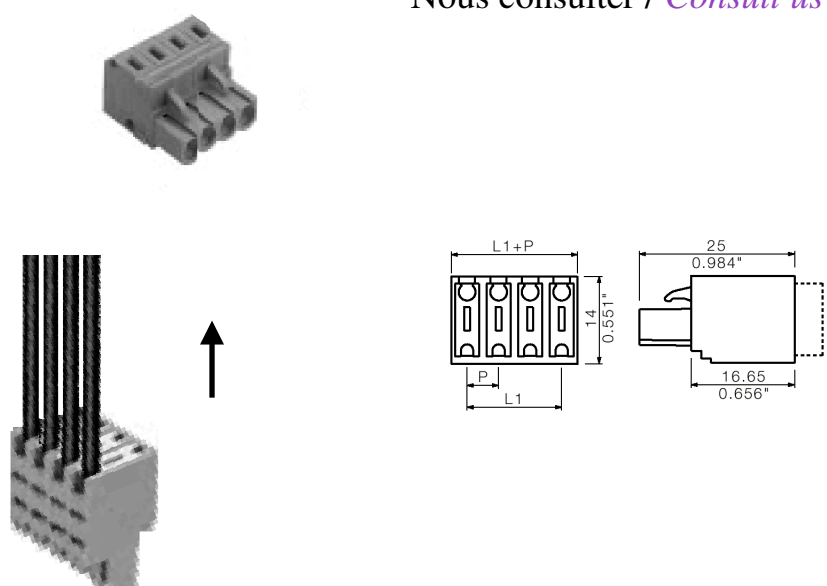
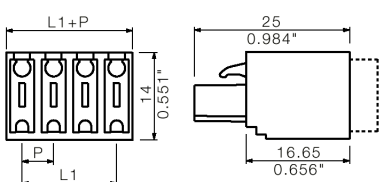
<p>Cosses <i>Crimp solutions</i></p>  <p>9</p>	<p>9 Cosses / <i>Crimp solutions</i></p> <p>Ref : <b>1Y021711</b> Weidmuller: BLC5,08/2/180R SW</p> <p>Ref : <b>1Y011567</b> Weidmuller: CTS FemBLAC 0,5/1mm<sup>2</sup> 1267060000 <i>(Single Contacts 20-17AWG)</i></p>  <p>- Autres tailles / <i>Other sizes</i> : 0,22 à/to 2,5mm<sup>2</sup> (nous consulter) <i>14-24 AWG (consult us)</i> - Dénudage / <i>Stripping length</i> = 5mm</p> <p>Process automatique (bandes) : nous consulter / <i>Automatic process (band) : consult us</i></p> 
<p>Connexion à déplacement d'isolant / <i>Insulation Displacement Connection</i></p>  <p>10</p>	<p>10 Nous consulter / <i>Consult us</i></p>  



**Montage /Mounting:**

- > Les relais statiques de la gamme **okpac<sup>®</sup>** doivent être montés sur dissipateur thermique. Une gamme étendue de dissipateurs est disponible. Voir exemples ci dessous et la gamme "WF" sur [www.celduc.com](http://www.celduc.com).
- okpac<sup>®</sup> SSRs must be mounted on heatsinks. A large range of heatsinks is available. See below some examples and "WF" range on [www.celduc.com](http://www.celduc.com).**
- > Pour le montage du relais sur dissipateur utiliser de la graisse thermique ou un "thermal pad" haute performance spécifié par **celduc<sup>®</sup>**. Une version autocollante précollée sur le relais est aussi disponible: nous consulter / *For heatsink mounting, it is necessary to use thermal grease or thermal pad with high thermal conductivity specified by **celduc<sup>®</sup>**. An adhesive model mounted by **celduc<sup>®</sup>** on the SSR is also available: please contact us.*

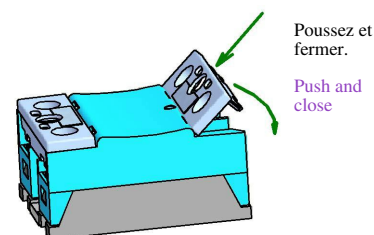
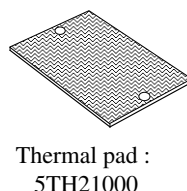
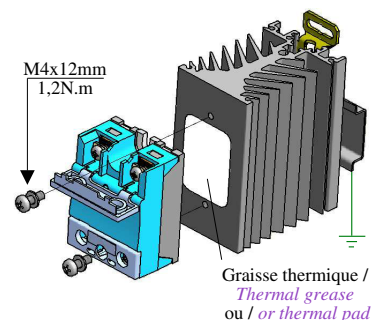
**Installation des volets IP20  
/ IP20 flaps mounting****Application typiques / Typical LOADS**

- > Les produit SOB9 sont définis principalement pour charge résistive AC-51 (chauffage).  
*SOB9 products are specially designed for AC-51 resistive load (heating).*

**Protection /Protection :**

- > La protection d'un relais statique contre les court-circuits de la charge peut être faite par fusibles rapides avec des  $I^2t = 1/2 I^2t$  du relais . Un test en laboratoire a été effectué sur les fusibles de marque FERRAZ.  
Une protection par MCB ( disjoncteurs modulaires miniatures) est aussi possible.  
Voir notre note application ( protection SSR) et utiliser des relais avec  $I^2t > 5000A^2s$   
*To protect the SSR against a short-circuit of the load , use a fuse with a  $I^2t$  value = 1/2  $I^2t$  value specified page 2.  
A test has been made with FERRAZ fuses .  
It is possible to protect SSR by MCB ( miniature circuit breaker).  
In this case, see application note ( SSR protection) and use a SSR with high  $I^2t$  value (5000A<sup>2</sup>s minimum).*

**EMC :**

- > **Immunité :** Nous spécifions dans nos notices le niveau d'immunité de nos produits selon les normes essentielles pour ce type de produit, c'est à dire EN61000-4-4 &5.

**Immunity :**

*We give in our data-sheets the immunity level of our SSRs according to the main standards for these products: EN61000-4-4 &5.*

- > **Emission:** Nos relais statiques sont principalement conçus et conformes pour la classe d'appareils A (Industrie).  
L'utilisation du produit dans des environnements domestiques peut amener l'utilisateur à employer des moyens d'atténuation supplémentaires. En effet, les relais statiques sont des dispositifs complexes qui doivent être interconnectés avec d'autres matériels (charges, cables, etc) pour former un système. Etant donné que les autres matériels ou interconnexions ne sont pas de la responsabilité de **celduc<sup>®</sup>**, il est de la responsabilité du réalisateur du système de s'assurer que les systèmes contenant des relais statiques satisfont aux prescriptions de toutes les règles et règlements applicables au niveau des systèmes.

Consulter **celduc<sup>®</sup>** qui peut vous conseiller ou réaliser des essais dans son laboratoire sur votre application.

**Emission:** **celduc<sup>®</sup>** SSRs are mainly designed in compliance with standards for class A equipment (Industry).

Use of this product in domestic environments may cause radio interference. In this case the user may be required to employ additional devices to reduce noise. SSRs are complex devices that must be interconnected with other equipment (loads, cables, etc.) to form a system. Because the other equipment or the interconnections may not be under the control of **celduc<sup>®</sup>**, it shall be the responsibility of the system integrator to ensure that systems containing SSRs comply with the requirement of any rules and regulations applicable at the system level.

Consult **celduc<sup>®</sup>** for advices. Tests can be preformed in our laboratory.