

SODF101-SH thru SODF107-SH

Surface Mount Glass Passivated Junction Fast Recovery Rectifiers
Reverse Voltage 50 to 1000V Forward Current 1.0A

FEATURES

- * Plastic package has Underwriters Laboratory Flammability Classification 94V-0
- * High temperature metallurgically bonded construction
- * Cavity-free glass passivated junction
- * Capable of meeting environmental standards of MIL-S-19500
- * Typical IR less than 1.0 μ A
- * High temperature soldering guaranteed: 260°C/10 seconds

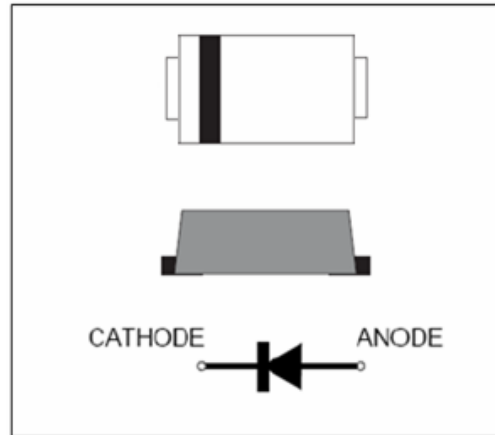

We declare that the material of product is Halogen free (green epoxy compound)

Mechanical Data

Case: JEDEC SOD123-FL/MINI SMA, molded plastic over glass DIE

Terminals: Plated leads, solderable per MIL-STD-750, Method 2026

Polarity: Color band denotes cathode end

Mounting Position Any

Weight: 0.0155 g

Handling precaution: None

Electrical Characteristic

1. Maximum & Thermal Characteristics Ratings at 25°C ambient temperature unless otherwise specified.

Parameter Symbol	symbol	SOD F101-SH	SOD F102-SH	SOD F103-SH	SOD F104-SH	SOD F105-SH	SOD F106-SH	SOD F107-SH	Unit
Device marking code		F1	F2	F3	F4	F5	F6	F7	
Maximum repetitive peak reverse voltage	V_{RRM}	50	100	200	400	600	800	1000	V
Maximum RMS voltage	V_{RMS}	35	70	140	280	420	560	700	V
Maximum DC blocking voltage	V_{DC}	50	100	200	400	600	800	1000	V
Maximum average forward rectified current lead length at $T_C = 75^\circ\text{C}$ (Note 2)	$I_{F(AV)}$	1.0							A
Peak forward surge current 8.3ms single half sine-wave superimposed on rated load (JEDEC Method)	I_{FSM}	30							A
Typical reverse recovery time (Note 1)	trr	150				250	500		ns
Typical thermal resistance (Note 2)	$R\theta_{JA}$	75							°C/W
Operating junction temperature range	T_J	-55 to +150							°C
storage temperature range	T_{STG}	-65 to +175							°C

Electrical Characteristics Ratings at 25°C ambient temperature unless otherwise specified.

Parameter Symbol	symbol	SOD F101-SH	SOD F102-SH	SOD F103-SH	SOD F104-SH	SOD F105-SH	SOD F106-SH	SOD F107-SH	Unit
Maximum instantaneous forward voltage at 1.0A	V_F	1.3							V
Maximum DC reverse current $T_J = 25^\circ\text{C}$ at rated DC blocking voltage $T_J = 125^\circ\text{C}$	I_R	5.0 100							μ A
Typical junction capacitance at 4.0V, 1MHz (Note 2)	C_J	15.0							PF

NOTES:

1. $I_F = 0.5\text{A}$, $I_R = 1.0\text{A}$, $IRR = 0.25\text{A}$

2. 8.0mm^2 (.013mm thick) land areas

SODF101-SH thru SODF107-SH

2. Characteristic Curves (TA = 25°C unless otherwise noted)

Fig. 1 - Forward Current Derating Curve

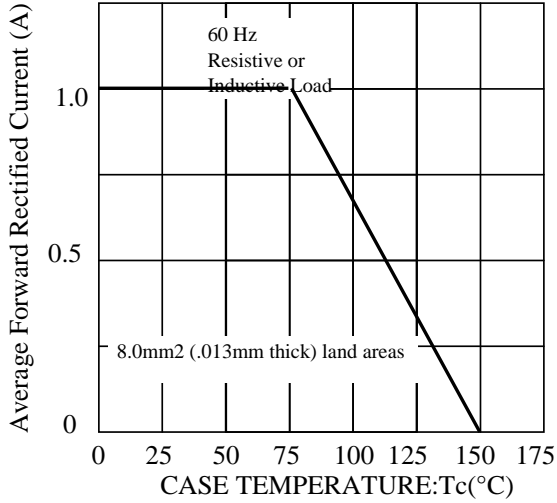

Fig. 2 - Maximum Non-repetitive Peak Forward Surge Current

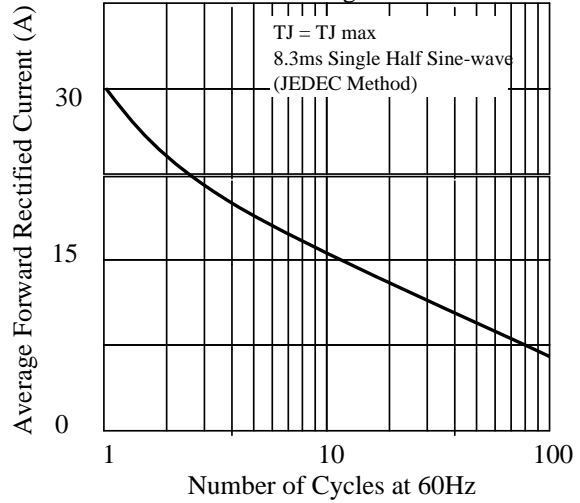

Fig 3. - Typical Instantaneous Forward Characteristics

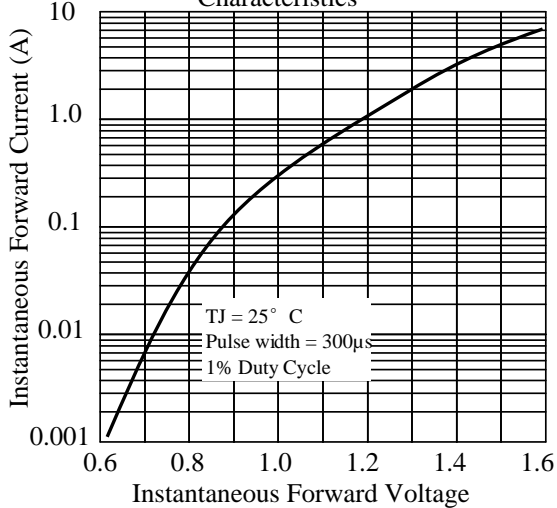

Fig 4. - Typical Reverse Characteristics

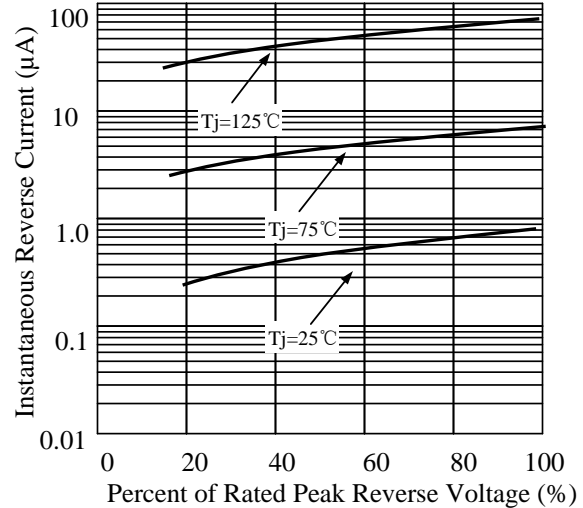

Fig 5. - typical transient thermal impedance

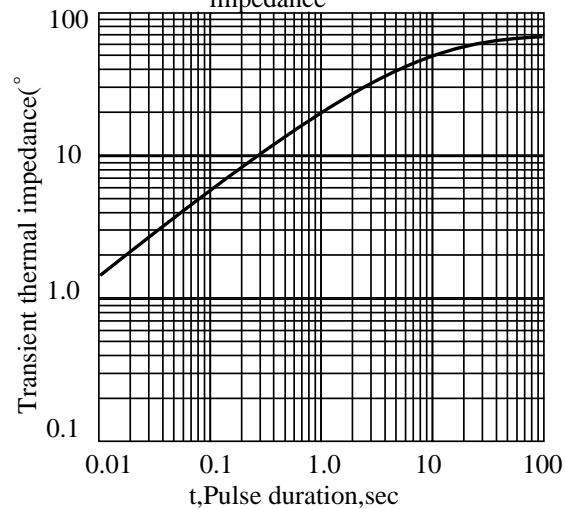
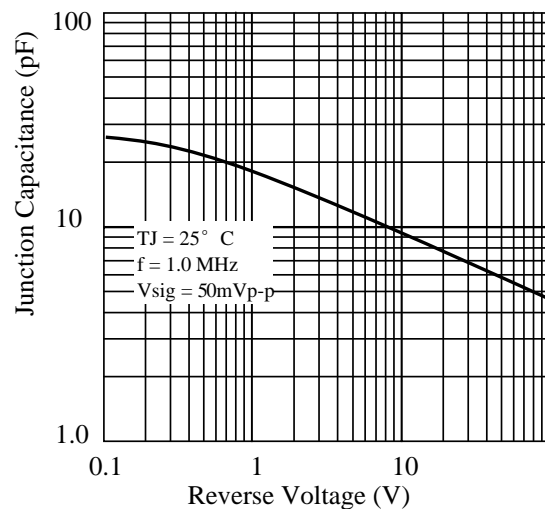

Fig 6. - Typical Junction Capacitance



SODF101-SH thru SODF107-SH

3. dimension:

SOD123-FL

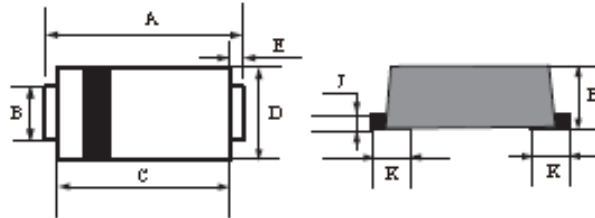

DIM	MILLIMETERS		INCHES	
	MIN	MAX	MIN	MAX
A	3.5	3.9	0.138	0.159
B	0.75	0.95	0.029	0.037
C	2.6	3.0	0.103	0.119
D	1.6	2.0	0.063	0.079
E	0.45Typ		0.018Typ	
H	0.9	1.2	0.036	0.047
J	0.12	0.22	0.005	0.009
K	0.8Typ		0.032Typ	

Suggested solder pad layout

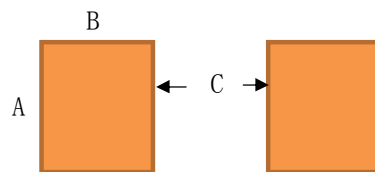

Dimensions in inches and (millimeters)

PACKAGE	A	B	C
SOD123-FL	0.044(1.10)	0.040(1.00)	0.079(2.00)

5.1 、 SMD Packing Reel Spec & Packing Quantity

5.1.1 Reel Packing

A. Reel Spec



unit: mm

SPEC	A	B	C	W	Quantity/Reel
SMA 7" reel	177.0±2.0	54.0±0.5	13.0±0.5	13.2±0.2	2K
SMA13" reel	330.0±2.0	75.0±0.5	13.0±0.5	13.2±0.2	5K
SMA-FL13" reel	330.0±2.0	75.0±0.5	13.0±0.5	13.2±0.2	5K
TO277 13" reel	330.0±2.0	75.0±0.5	13.0±0.5	13.2±0.2	5K
SOD123FL 7" reel	177.0±2.0	50.0±0.5	13.0±0.5	9.4±1.5	3K
SOD323HE 7" reel	177.0±2.0	50.0±0.5	13.0±0.5	9.4±1.5	3K
SMB-FL 13" reel	330.0±2.0	75.0±0.5	13.0±0.5	13.2±0.2	5K

B. 13" reel packing box

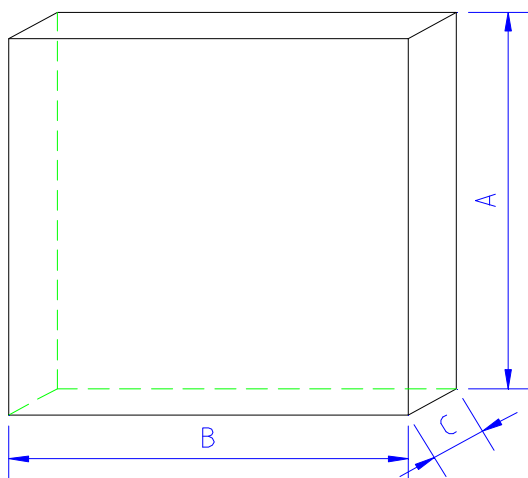

unit: mm

size	A	B	C
	335±5.0	335±2.0	40±1.0

as per above packing

Spec	Q' ty/Box
SMA13" reel	10K
TO277 13" reel	10K
SMB-FL 13" reel	10K

Title:
Power Diode SMD Package Packing Spec

DOC NO.: WI-258

DOC NO.: WI-258

Page: 3

C. 7" reel packing box

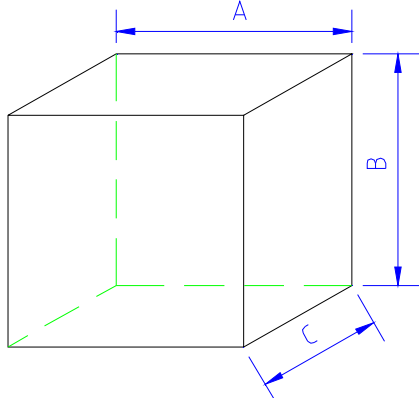

unit: mm

	A	B	C
SMA/SMA-FL	188±2.0	188±2.0	138±2.0
SOD123FL SOD323HE	186±2.0	139±2.0	185±2.0

as per above packing

	Q' ty/Box
SMA/SMA-FL	16K
SOD123FL	30K
SOD323HE	30K

D. reel packing carton

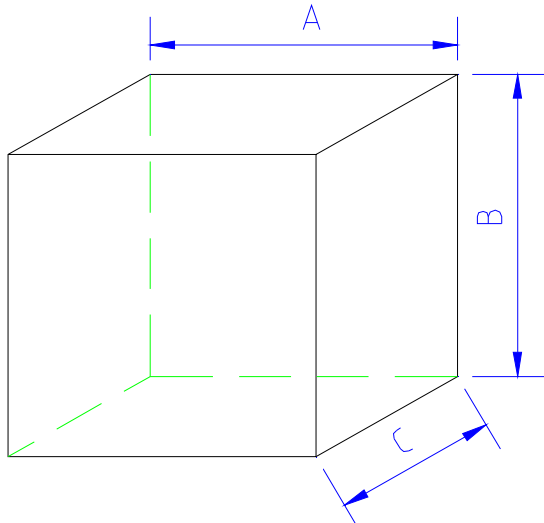

unit: mm

	A	B	C
size	350±2.0	340±2.0	350±2.0

as per above packing

Spec	Q' ty/Carton
SMA/SMA-FL 7" reel	80K
SMA13"reel	80K
SMA-FL13"reel	80K
TO277 13" reel	80K
SMB-FL 13" reel	80K

unit: mm

	A	B	C
SOD123FL SOD323HE	455±2.0	400±2.0	410±2.0

as per above packing

Spec	Q' ty/Carton
SOD123-FL 7" reel	360K
SOD323HE 7" reel	360K

5.1.2 Tape Spec

A. Cover Tape

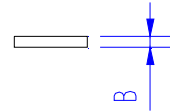

unit: mm

	A	B
SMA /SMA-FL SMB-FL /TO277	9.5±0.10	0.062±0.007
SOD123FL SOD323HE	5.4±0.10	

5.2、SMD Power Diode General Packing Spec

A. 7" reel all labels will be at cathode side of reel ;

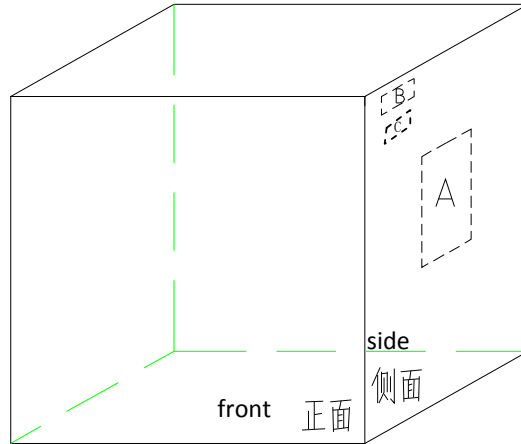

A:LRC label;

B:Environment Label C:Halide free label

B. 13" reel

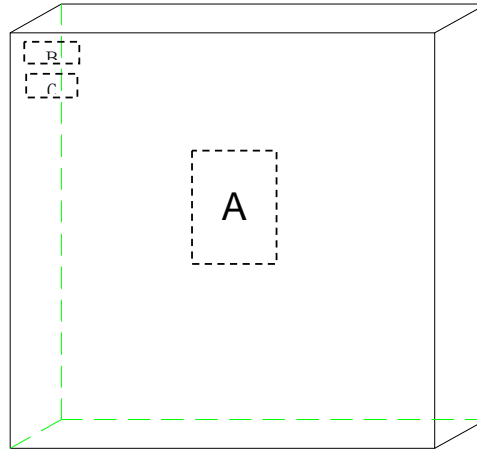
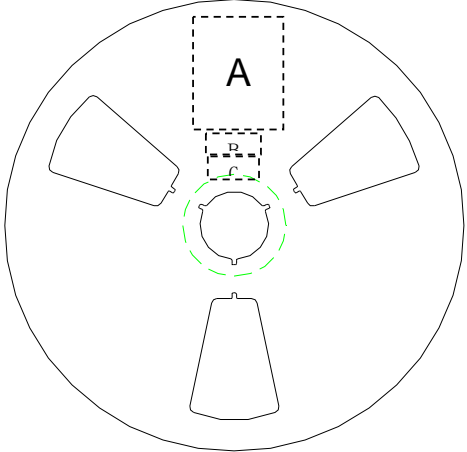

A:LRC label;

B:Environment Labe C:Halide free label

C. Tape lead: face anode side of the reel, upper side is the tape lead position. All labels are at cathode side of the reel.



标题:

Power Diode SMD Package Packing Spec

DOC NO.: WI-258

Version: 5 Modification: 0

Page: 6

C. Label Content :
LRC Label

P/N → (1P) LPN: SM140A
Lot No. → (1T) LOT: 140106049X
Date code → (9D) DTE: 1403
Quantity → (Q) QTY: 10000

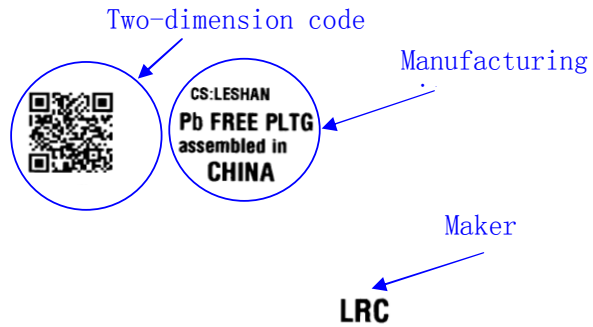

lot: 140106049X: 140106---2014/1/6; 049----lot number:49; X: product code

Environment Label



Halide-free Label



SODF101-SH thru SODF107-SH

Reel packing

PACKAGE	REEL SIZE	REEL (PCS)	COMPONENT SPACING (mm)	BOX (pcs)	INNER BOX (mm)	REEL DIA. (mm)	CARTON SIZE (mm)	CARTON (PCS)	APPROX. GROSS WEIGHT (kg)
SOD123-FL	7"	3,000	4.0	30,000	183*183*123	178	382*262*387	240,000	8.7

5.Suggested thermal profile for soldering process

1. Storage environment : Temperature=5~40°C Humidity=55±25%
2. Reflow soldering of surface-mount device

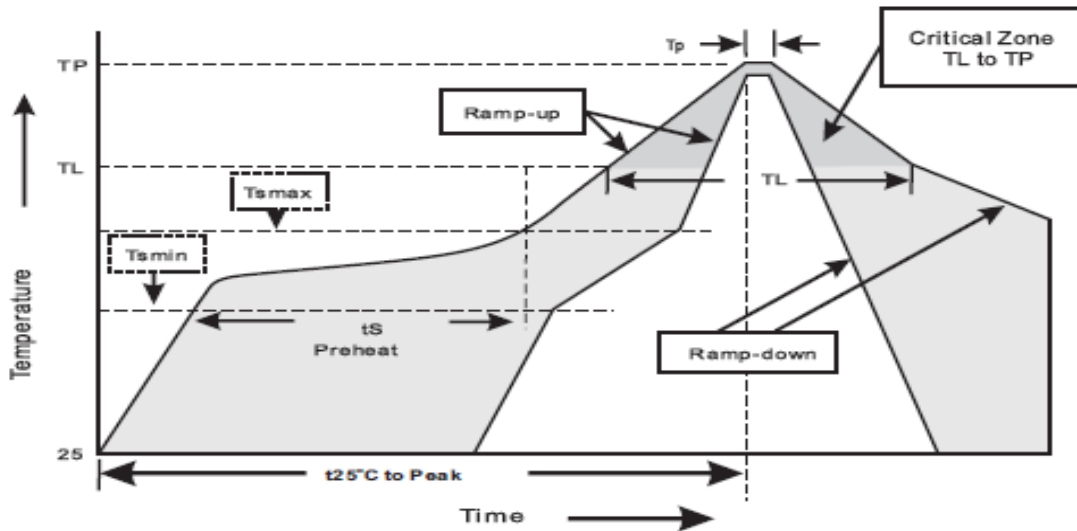

3. Reflow soldering

Profile Feature	Soldering Condition
Average ramp-up rate(T_L to T_P)	<3°C/sec
Preheat	
- Temperature Min(T_{smin})	150°C
- Temperature Max(T_{smax})	200°C
- Time(min to max)(t_s)	60~120sec
T_{smax} to T_L	
- Ramp-up Rate	<3sec
Time maintained above:	
- Temperature (T_L)	217°C
- Time(t_L)	60-260sec
Peak Temperature(T_P)	255 -0/+5°C
Time within 5°C of actual Peak Temperature(T_P)	10~30sec
Ramp-down Rate	<6°C/sec
Time 25°C to Peak Temperature	<6minutes

SODF101-SH thru SODF107-SH

6.High reliability test capabilities

Item Test	Condition	Reference
Solder Resistance	at 260±5°C for 10±2sec immerse body into solder 1/16" ± 1/32"	MIL-STD-750D METHOD-2031
Solderability	at 245±5°C for 5 sec	MIL-STD-202F METHOD-208
High Temperature Reverse Bias	V _R =80% rate at T _J =150°C for 168hrs	MIL-STD-750D METHOD-1038
Forward Operation Life	Rated average rectifier current T _A =25°C for 500hrs	MIL-STD-750D METHOD-1027
Intermittent Operation Life	T _A =25°C , I _F =I _o On state:power on for 5 min. Off state:power off for 5 min. on and off for 500 cycles	MIL-STD-750D METHOD-1036
Pressure Cooker	15P _{SIG} at T _A =121°C for 4hrs	JESD22-A102
Temperature Cycling	-55°C to +125°C dwelled for 30 min. and transferred for 5min. Total 10 cycles	MIL-STD-750D METHOD-1051
Thermal Shock	0°C for 5min. Rise to 100°C for 5min. Total 10 cycles	MIL-STD-750D METHOD-1056
Forward Surge	8.3ms single half sine-wave superimposed on rated load,one surge	MIL-STD-750D METHOD-4066-2
Humidity	at T _A =85°C , RH=85% for 1000hrs	MIL-STD-750D METHOD-1021
High Temperature Storage Life	at 175°C for 1000hrs	MIL-STD-750D METHOD-1031

SODF101-SH thru SODF107-SH

7. Update Record

版次	更新记录	更新作者	更新日期
1	第一版	周杰	2012.06.11
2	管体高度由0.8~1.0mm修正为0.8~1.2mm; 引脚厚度由0.18~0.22mm调整为0.12~0.22mm;	周杰	2012.12.05
3	因为所有SOD123系列均为无卤塑料, 所以取消印字下划线	周杰	2013.01.04
4	将封装SOD-123S修正为SOD123-FL	周杰	2013.03.20