

SP1053 8.5pF 8kV 01005 DFN Plastic Unidirectional Discrete TVS **HF** **RoHS** **GREEN**

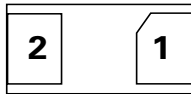

**Pinout**



Note: Drawing not to scale

**Functional Block Diagram**



Life Support Note:

**Not Intended for Use in Life Support or Life Saving Applications**

The products shown herein are not designed for use in life sustaining or life saving applications unless otherwise expressly indicated.

**Description**

Avalanche breakdown diodes fabricated in a proprietary silicon avalanche technology protect each I/O pin to provide a high level of protection for electronic equipment that may experience destructive electrostatic discharges (ESD). These robust diodes can safely absorb repetitive ESD strikes at  $\pm 8\text{kV}$  (contact discharge, IEC 61000-4-2) without performance degradation. Additionally, each diode can safely withstand 1.0A surge (8/20 waveshape as defined in IEC 61000-4-5 2nd edition) at a very low clamping voltage.

**Features**

- ESD, IEC 61000-4-2,  $\pm 8\text{kV}$  contact,  $\pm 15\text{kV}$  air
- EFT, IEC 61000-4-4, 40A (5/50ns)
- Lightning, 1.0A (8/20 as defined in IEC 61000-4-5 2<sup>nd</sup> edition)
- Low capacitance of 8.5 pF (@  $V_R=0\text{V}$ )
- Low leakage current of 0.02 $\mu\text{A}$  (TYP) at 5V
- Unidirectional solutions presents half the dynamic resistance of a bidirectional device protects faster and better
- Industry's smallest ESD footprint available (01005 DFN plastic)
- Halogen free, Lead free and RoHS compliant
- Moisture Sensitivity Level(MSL -1)
- AEC-Q101 qualified

**Applications**

- Mobile Phones
- Smart Phones
- Camcorders
- Portable Medical
- Digital Cameras
- Wearable Technology
- Portable Navigation Components
- Tablets
- Point of Sale Terminals
- Identification Modules

**Application Example**

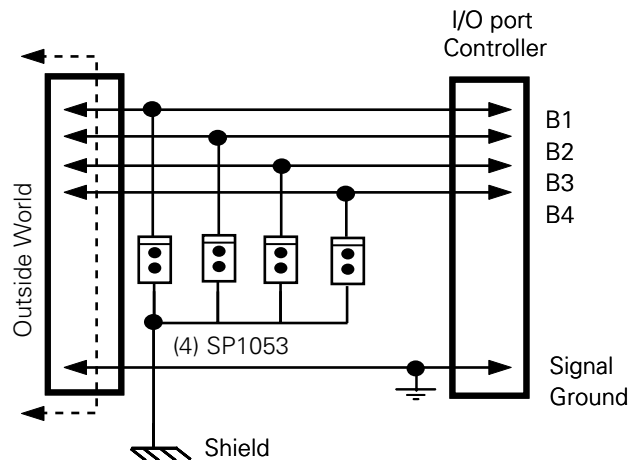

### Absolute Maximum Ratings

Symbol	Parameter	Value	Units
$I_{PP}$	Peak Current ( $t_p=8/20\mu s$ )	1.0 <sup>1</sup>	A
$T_{OP}$	Operating Temperature	-40 to 125	°C
$T_{STOR}$	Storage Temperature	-55 to 150	°C

Notes:

1. CAUTION: Stresses above those listed in "Absolute Maximum Ratings" may cause permanent damage to the component. This is a stress only rating and operation of the component at these or any other conditions above those indicated in the operational sections of this specification is not implied.

### Electrical Characteristics ( $T_{OP}=25^\circ C$ )

Parameter	Symbol	Test Conditions	Min	Typ	Max	Units
Reverse Standoff Voltage	$V_{RWM}$				6.0	V
Breakdown Voltage	$V_{BR}$	$I_R=1mA$ ,	6.5	7.0		V
Leakage Current	$I_{LEAK}$	$V_R=5V$ with 1 pin at GND		0.02	0.5	$\mu A$
Clamp Voltage <sup>1</sup>	$V_C$	$I_{PP}=1A$ , $t_p=8/20\mu s$ , Fwd		9	12	V
Dynamic Resistance <sup>2</sup>	$R_{DYN}$	TLP, $t_p=100ns$ , I/O to GND		0.47		$\Omega$
ESD Withstand Voltage <sup>1</sup>	$V_{ESD}$	IEC 61000-4-2 (Contact Discharge)	$\pm 8$			kV
		IEC 61000-4-2 (Air Discharge)	$\pm 15$			kV
Diode Capacitance <sup>1</sup>	$C_D$	Reverse Bias=0V		8.5		pF

Note:

1 Parameter is guaranteed by design and/or component characterization.

2. Transmission Line Pulse (TLP) with 100ns width, 2ns rise time, and average window  $t_1=70ns$  to  $t_2=90ns$

### Capacitance vs. Reverse Bias

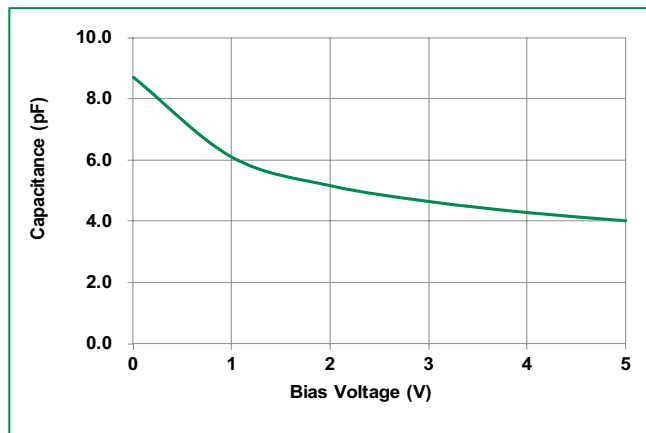

### 8/20 $\mu s$ Pulse Waveform

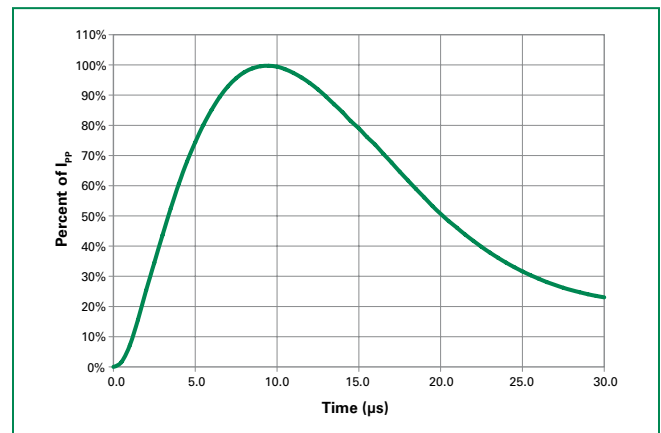

**IEC 61000-4-2 +8 kV Contact ESD Clamping Voltage**

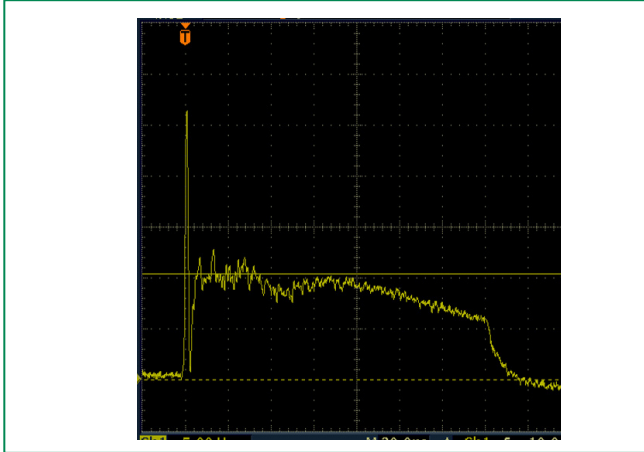

**IEC 61000-4-2 -8 kV Contact ESD Clamping Voltage**

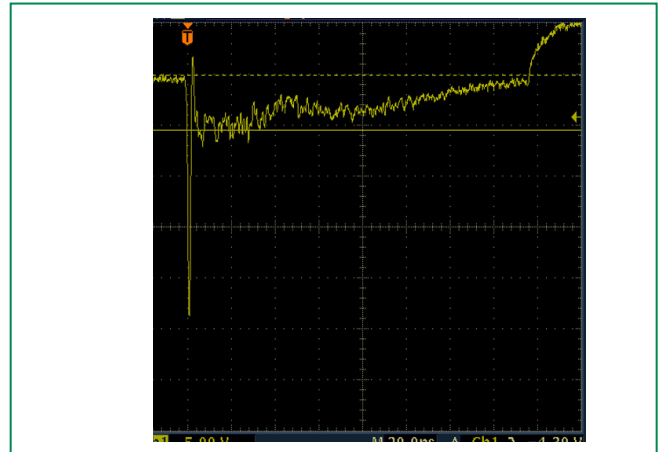

**Positive Transmission Line Pulsing (TLP) Plot**

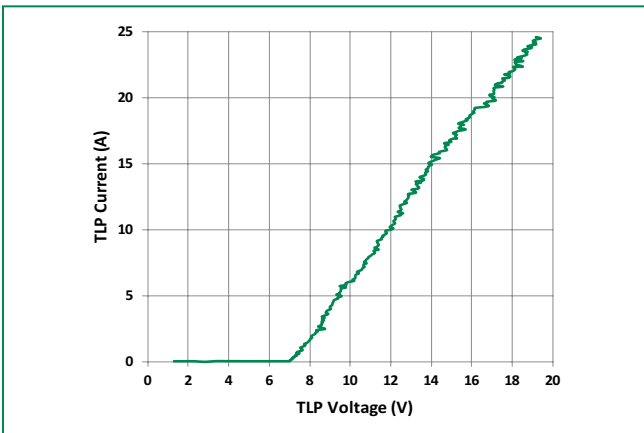

**Negative Transmission Line Pulsing (TLP) Plot**

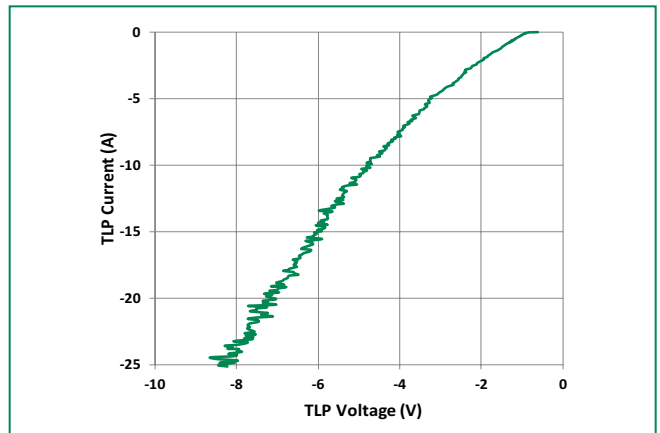

**Soldering Parameters**

Reflow Condition		Pb – Free assembly
Pre Heat	- Temperature Min ( $T_{s(min)}$ )	150°C
	- Temperature Max ( $T_{s(max)}$ )	200°C
	- Time (min to max) ( $t_s$ )	60 – 180 secs
Average ramp up rate (Liquidus) Temp ( $T_L$ ) to peak		3°C/second max
$T_{s(max)}$ to $T_L$ - Ramp-up Rate		3°C/second max
Reflow	- Temperature ( $T_L$ ) (Liquidus)	217°C
	- Temperature ( $t_L$ )	60 – 150 seconds
Peak Temperature ( $T_p$ )		260 <sup>+0/-5</sup> °C
Time within 5°C of actual peak Temperature ( $t_p$ )		20 – 40 seconds
Ramp-down Rate		6°C/second max
Time 25°C to peak Temperature ( $T_p$ )		8 minutes Max.
Do not exceed		260°C

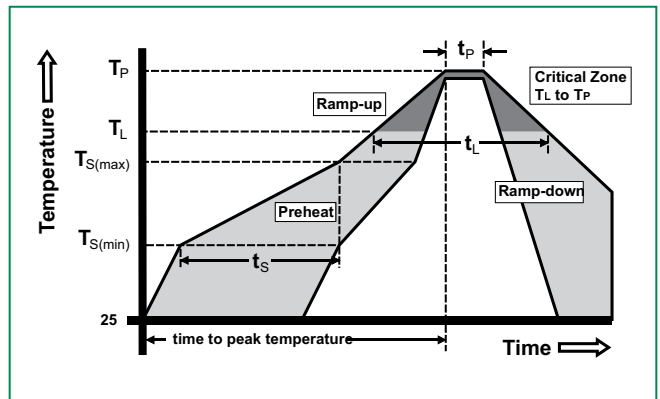

**Product Characteristics**

<b>Lead Plating</b>	Pre-Plated Frame
<b>Lead Material</b>	Copper Alloy
<b>Substrate material</b>	Silicon
<b>Body Material</b>	Molded Compound
<b>Flammability</b>	UL Recognized compound meeting flammability rating V-0.

Notes :  
1. All dimensions are in millimeters  
2. Dimensions include solder plating.  
3. Dimensions are exclusive of mold flash & metal burr.

**Part Numbering System**

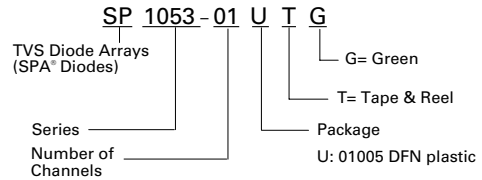

**Part Marking System**

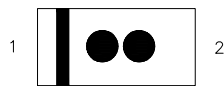

**Ordering Information**

Part Number	Package	Min. Order Qty.
SP1053-01UTG	01005 DFN plastic	20000

**Package Dimensions — 01005 DFN plastic**

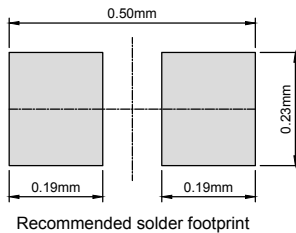
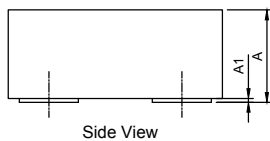
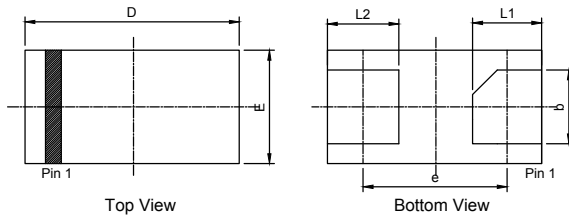

Symbol	01005 DFN					
	Millimeters			Inches		
	Min	Typ	Max	Min	Typ	Max
<b>A</b>	0.235	0.250	0.265	0.0093	0.0098	0.0104
<b>A1</b>	-	0.015	0.020	-	0.0006	0.0008
<b>b</b>	0.100	0.150	0.200	0.0039	0.0059	0.0079
<b>D</b>	0.385	0.435	0.485	0.0152	0.0171	0.0191
<b>E</b>	0.200	0.250	0.300	0.0079	0.0098	0.0118
<b>e</b>	0.293			0.0115		
<b>L1</b>	0.090	0.140	0.190	0.0035	0.0055	0.0075
<b>L2</b>	0.095	0.145	0.195	0.0037	0.0057	0.0077

**Embossed Carrier Tape & Reel Specification – 01005 DFN plastic**

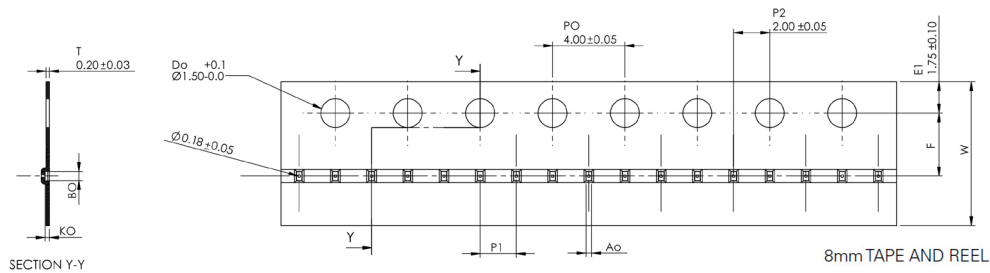

Symbol	Millimeters
<b>A0</b>	0.29 +0.02/-0.03
<b>B0</b>	0.505 +/-0.03
<b>K0</b>	0.275 +0.03/-0.10
<b>F</b>	3.5 +/- 0.05
<b>P1</b>	2.00 +/-0.05
<b>W</b>	8.00 +/-0.10

SECTION Y-Y

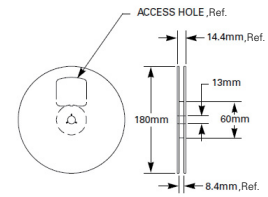
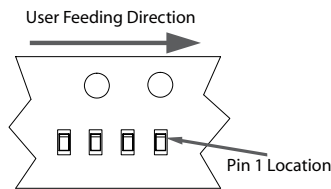

**Disclaimer Notice - Information furnished is believed to be accurate and reliable. However, users should independently evaluate the suitability of and test each product selected for their own applications. Littelfuse products are not designed for, and may not be used in, all applications. Read complete Disclaimer Notice at <http://www.littelfuse.com/disclaimer-electronics>.**