

**SP3422 0.2pF 22kV Diode Array**

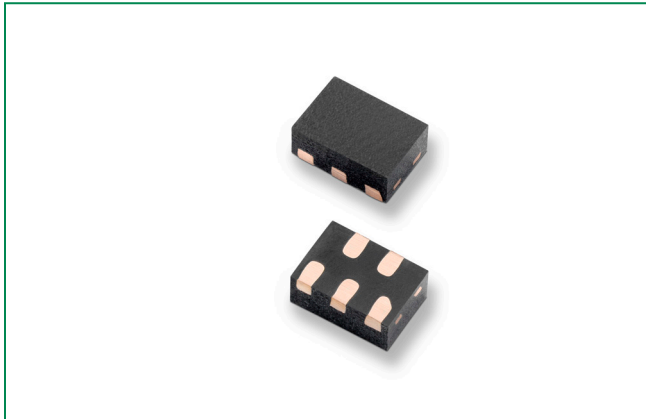

**Pinout**

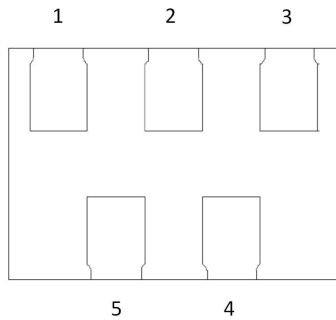

**Functional Block Diagram**

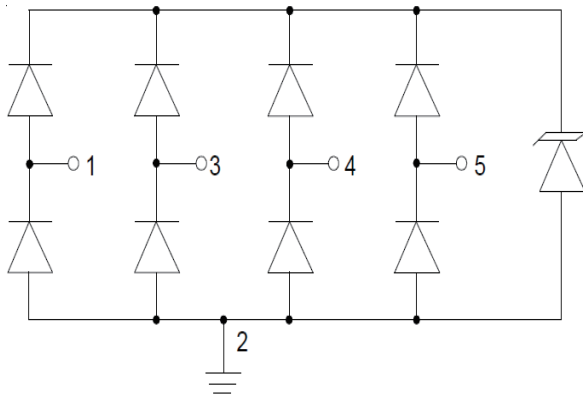

**Description**

The SP3422 integrates 4 channels of ultra low capacitance rail-to-rail diodes and an additional zener diode to provide protection for electronic equipment that may experience destructive electrostatic discharges (ESD). This robust component can safely absorb repetitive ESD strikes above the maximum level specified in the IEC 61000-4-2 international standard ( $\pm 8\text{kV}$  contact discharge) without performance degradation. The extremely low loading capacitance also makes it ideal for protecting high speed signal pins such as V-by-One®, USB3.0, USB2.0, and IEEE 1394.

**Features**

- ESD, IEC 61000-4-2, +22/-10kV contact, +22/-10kV air
- EFT, IEC 61000-4-4, 40A ( $t_p=5/50\text{ns}$ )
- Lightning, IEC 61000-4-5 2<sup>nd</sup> edition, 2A ( $t_p=8/20\mu\text{s}$ )
- Low capacitance of 0.2pF (TYP) at 3GHz
- Low leakage current of 20nA (TYP) at 5V
- Halogen free, Lead free and RoHS compliant
- Moisture Sensitivity Level(MSL -1)

**Applications**

- V-by-One®
- Embedded DisplayPort
- USB 2.0/3.0 Ports
- MIPI Camera and Display
- Serial bus interfaces such as IEEE 1394
- Flat Panel Displays
- LCD/LED TVs
- Smartphones
- Mobile Computing

Life Support Note:

**Not Intended for Use in Life Support or Life Saving Applications**

The products shown herein are not designed for use in life sustaining or life saving applications unless otherwise expressly indicated.

**Absolute Maximum Ratings**

Symbol	Parameter	Value	Units
$I_{PP}$	Peak Current ( $t_p=8/20\mu s$ )	2.0	A
$T_{OP}$	Operating Temperature	-40 to 125	°C
$T_{STOR}$	Storage Temperature	-55 to 150	°C

CAUTION: Stresses above those listed in "Absolute Maximum Ratings" may cause permanent damage to the component. This is a stress only rating and operation of the component at these or any other conditions above those indicated in the operational sections of this specification is not implied.

**Electrical Characteristics ( $T_{OP}=25^\circ C$ )**

Parameter	Symbol	Test Conditions	Min	Typ	Max	Units
Reverse Standoff Voltage	$V_{RWM}$	$I_R \leq 1\mu A$			5.0	V
Reverse Leakage Current	$I_{LEAK}$	$V_R=5V$ , Any I/O to GND		0.02	1.00	$\mu A$
Clamp Voltage <sup>1</sup>	$V_C$	$I_{PP}=1A$ , $t_p=8/20\mu s$ , Fwd		12.9		V
		$I_{PP}=2A$ , $t_p=8/20\mu s$ , Fwd		16.7		V
Dynamic Resistance <sup>2</sup>	$R_{DYN}$	TLP, $t_p=100ns$ , I/O to GND		1.8		$\Omega$
ESD Withstand Voltage <sup>1</sup>	$V_{ESD}$	IEC 61000-4-2 (Contact)	+22/-10			kV
		IEC 61000-4-2 (Air)	+22/-10			kV
Diode Capacitance <sup>1</sup>	$C_{I/O-GND}$	Reverse Bias=0V, f=3 GHz		0.2		pF

Note: <sup>1</sup> Parameter is guaranteed by design and/or component characterization.

<sup>2</sup> Transmission Line Pulse (TLP) with 100ns width, 2ns rise time, and average window  $t_1=70ns$  to  $t_2=90ns$

**Positive Transmission Line Pulsing (TLP) Plot**

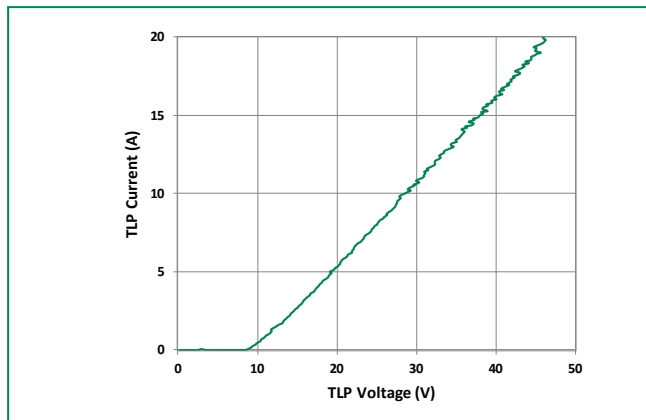

**Negative Transmission Line Pulsing (TLP) Plot**

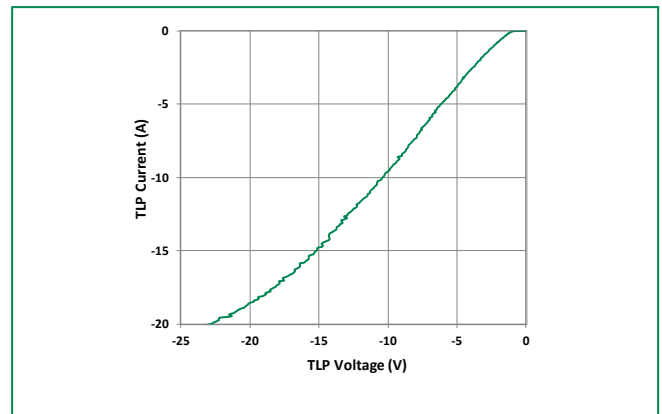

**IEC 61000-4-2 +8 kV Contact ESD Clamping Voltage**

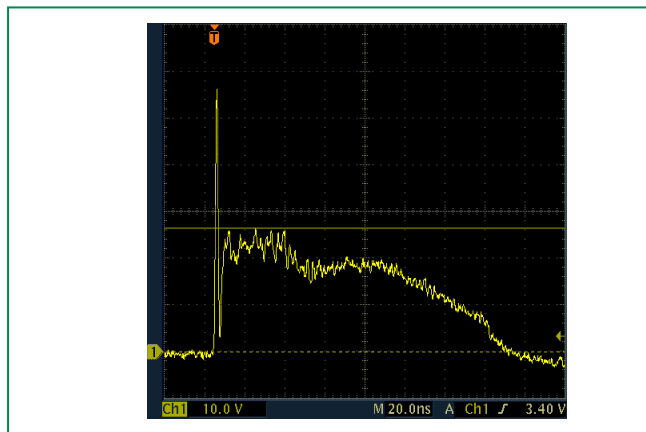

**IEC 61000-4-2 -8 kV Contact ESD Clamping Voltage**

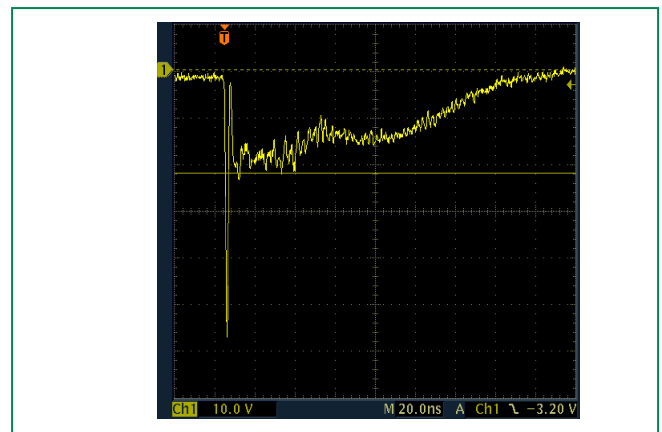

**8/20µs Pulse Waveform**

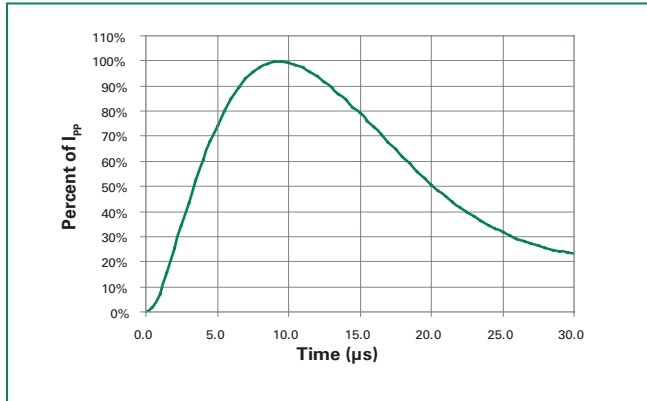

**Clamping Voltage vs I\_PP**

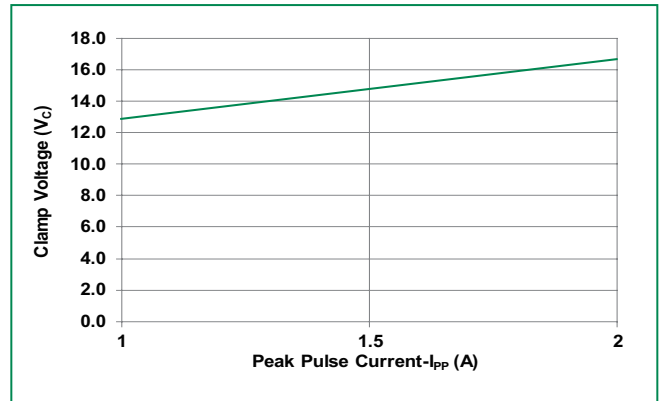

**Soldering Parameters**

Reflow Condition		Pb – Free assembly
Pre Heat	- Temperature Min ( $T_{s(min)}$ )	150°C
	- Temperature Max ( $T_{s(max)}$ )	200°C
	- Time (min to max) ( $t_s$ )	60 – 180 secs
Average ramp up rate (Liquidus) Temp ( $T_L$ ) to peak		3°C/second max
$T_{s(max)}$ to $T_L$ - Ramp-up Rate		3°C/second max
Reflow	- Temperature ( $T_L$ ) (Liquidus)	217°C
	- Temperature ( $t_L$ )	60 – 150 seconds
Peak Temperature ( $T_p$ )		260 <sup>+0/-5</sup> °C
Time within 5°C of actual peak Temperature ( $t_p$ )		20 – 40 seconds
Ramp-down Rate		6°C/second max
Time 25°C to peak Temperature ( $T_p$ )		8 minutes Max.
Do not exceed		260°C

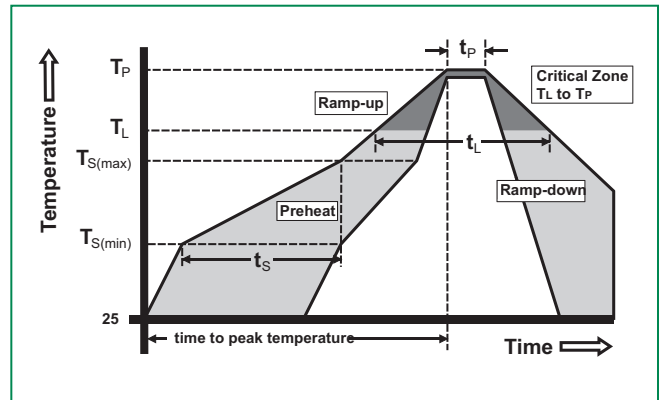

**Part Numbering System**

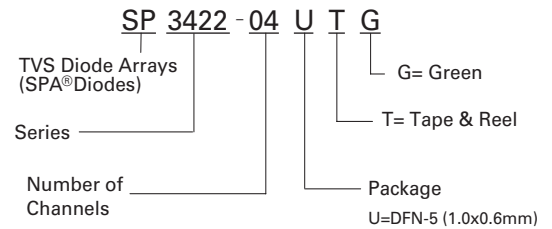

**Ordering Information**

Part Number	Package	Marking	Min. Order Qty.
SP3422-04UTG	µDFN-5	B*	3000

**Part Marking System**

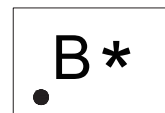

B = Part code = SP3422-04UTG  
\* = Date code

**Package Dimensions**

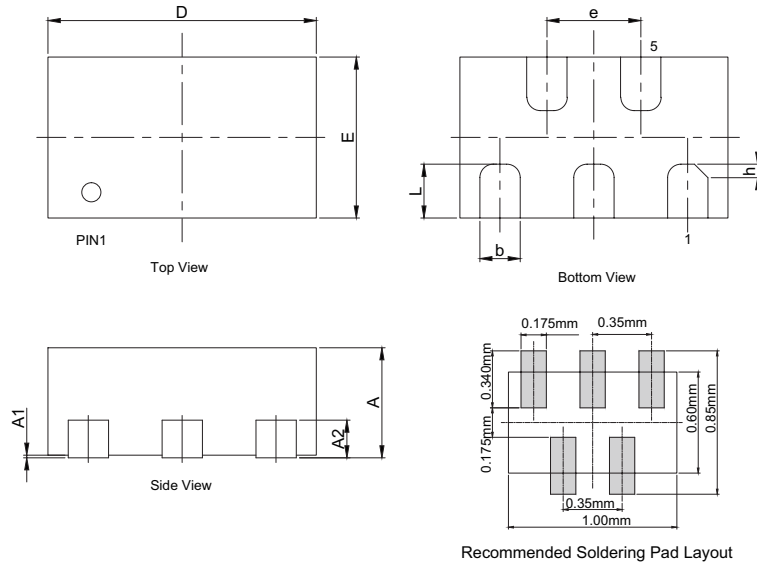

Symbol	1.0x0.6mm DFN		
	Millimeters		
	Min	Nor	Max
<b>A</b>	0.40	0.45	0.50
<b>A1</b>	0.00	0.02	0.05
<b>A2</b>	0.127 REF		
<b>b</b>	0.10	0.15	0.20
<b>D</b>	0.90	1.00	1.10
<b>E</b>	0.50	0.60	0.70
<b>e</b>	0.35 BSC		
<b>L</b>	0.125	0.225	0.325
<b>h</b>	0.05 (x 45°)		

**Embossed Carrier Tape & Reel Specification**

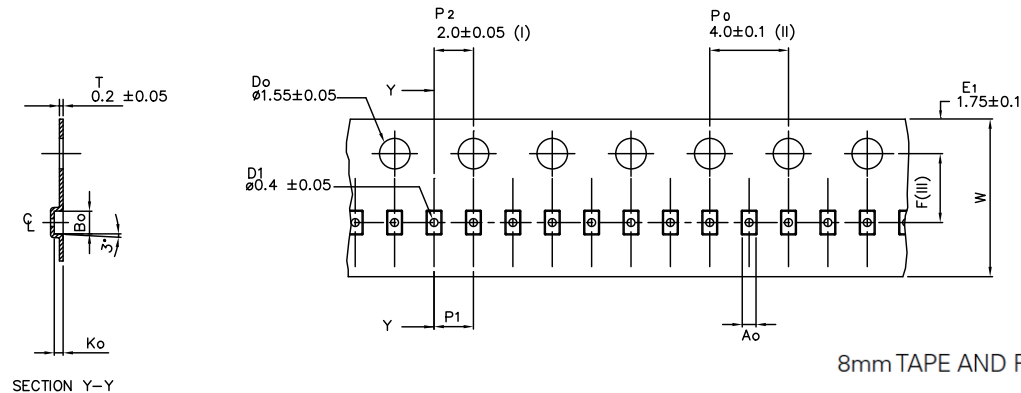

Symbol	Millimeters
<b>A0</b>	0.70 +/- 0.05
<b>B0</b>	1.15 +/- 0.05
<b>K0</b>	0.47 +/- 0.05
<b>F</b>	3.50 +/- 0.05
<b>P1</b>	2.00 +/- 0.10
<b>W</b>	8.00 +/- 0.10

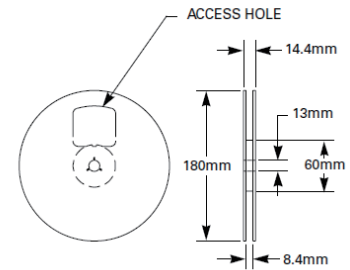
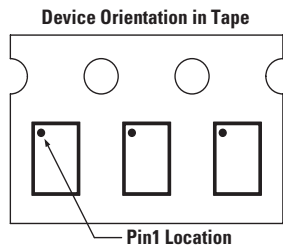

**Disclaimer Notice - Information furnished is believed to be accurate and reliable. However, users should independently evaluate the suitability of and test each product selected for their own applications. Littelfuse products are not designed for, and may not be used in, all applications. Read complete Disclaimer Notice at [www.littelfuse.com/disclaimer-electronics](http://www.littelfuse.com/disclaimer-electronics).**