



SP6852

Green-Mode Power Switch

DESCRIPTION

The SP6852 is a low cost, low startup current, current mode PWM controller with green-mode power-saving operation. Built-in 700V MOSFET provides simple design for adapter. The integrated functions include the leading-edge blanking of the current sensing, internal slope compensation. It would provide the users a superior AC/DC power application of higher efficiency, low external component counts, and lower cost solution for applications.

The SP6852 features more protections or functions for the following characteristics :

※Add OLP (Over Load Protection) function to provide better protection performance for fault conditions like short circuit or over load.

※Modify the OVP (Over Voltage Protection) mechanism from the cycle-by-cycle mode to the hiccup mode.

SP6852 is available in DIP-8P package.

FEATURES

- High-Voltage BiCMOS Process
- Very Low Startup Current (<math><20\mu\text{A}</math>)
- Under Voltage Lockout (UVLO)
- Current Mode Control
- Non-audible-noise Green Mode Control
- Current Limiting
- OLP (Over Load Protection)
- OVP (Over Voltage Protection) on Vcc Pin
- Leading-Edge Blanking
- Programmable Switching Frequency
- Internal Slope Compensation
- Green-Mode Control for Power Saving
- Building in 650V MOSFET

APPLICATIONS

- AC/DC Switching Power Adaptor
- Battery Charger
- PC 5V Standby Power.
- Open-Frame Switching Power Supply

PIN CONFIGURATION

DIP-8P

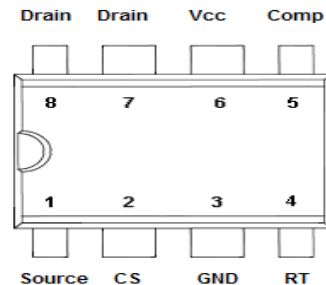

PART MARKING

DIP-8P

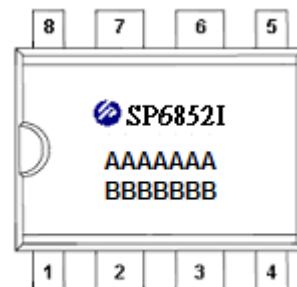

A : Lot Code
B : Date Code



SP6852 Green-Mode Power Switch

TYPICAL APPLICATION CIRCUIT

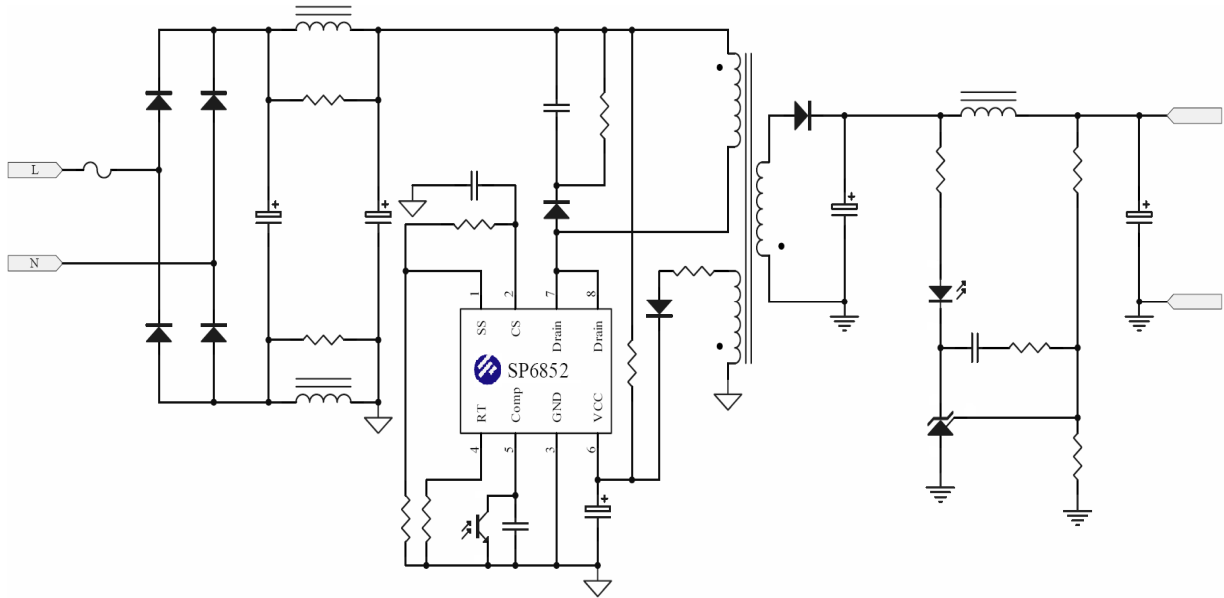

TYPICAL APPLICATION CIRCUIT for HIGH EFFICIENCY SMPS

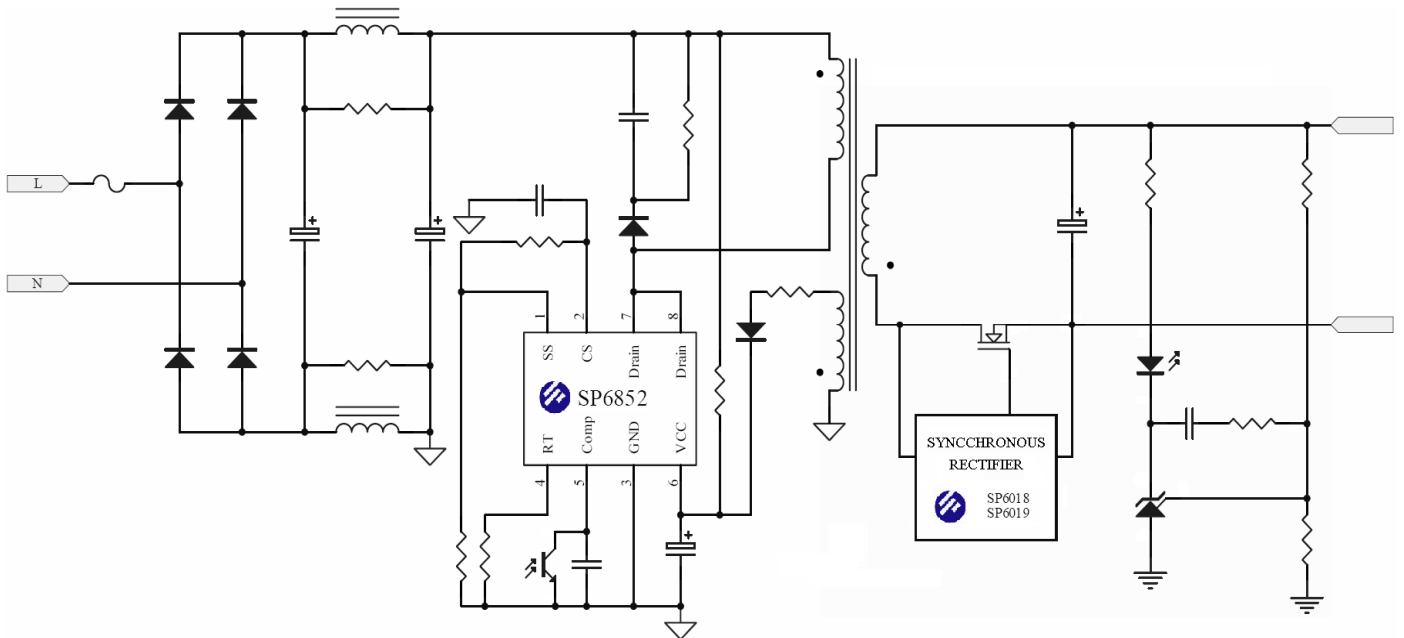



SP6852

Green-Mode Power Switch

PIN DESCRIPTION

Pin	Symbol	Description
1	Source	Power MOSFET Source
2	CS	Current sense. This pin senses the voltage across a resistor, to control PWM output. This pin also provides current amplitude information for current-mode control.
3	GND	Ground
4	RT	This current is used to charge an internal capacitor, to determine the switching frequency.
5	COMP	Voltage feedback. The pin provides the output voltage regulation signal, it provides feedback to the internal PWM comparator, so that the PWM comparator can control the duty cycle.
6	VCC	Supply Voltage in
7	Drain	Power MOSFET Drain
8	Drain	Power MOSFET Drain

BLOCK DIAGRAM

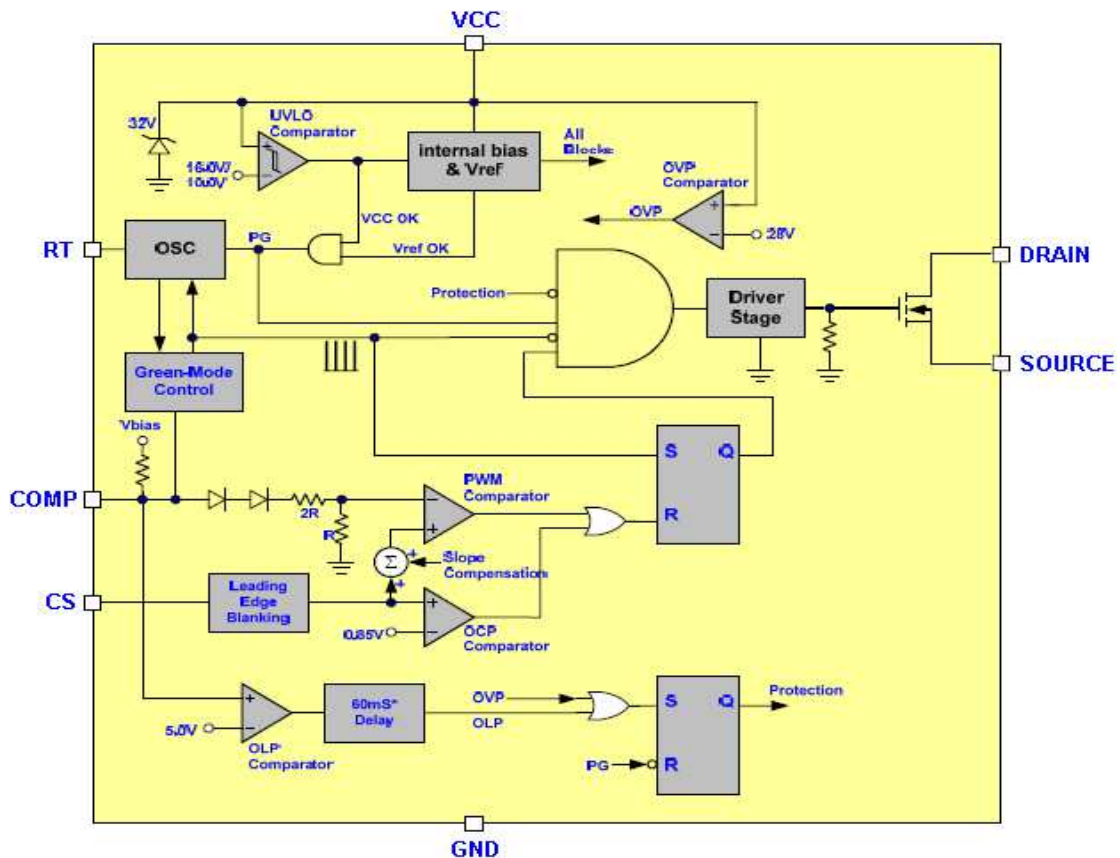



SP6852

Green-Mode Power Switch

ORDERING INFORMATION

Part Number	Package	Part Marking
SP6852D8TG	DIP-8P	SP6852I

※ SP6852D8TG : Tube ; Pb – Free

ABSOLUTE MAXIMUM RATINGS (T_A=25°C, unless otherwise specified.)

The following ratings designate persistent limits beyond which damage to the device may occur.

Symbol	Parameter	Value	Unit
V _{CC}	DC Supply Voltage	36	V
V _{COMP/RT/CS}	COMP / RT / CS Voltage	-0.3 ~ 7.0	V
V _{DS}	MOSFET Breakdown Voltage	700	V
P _D	Power Dissipation @ T _A =85°C (*)	0.3	W
ESD	Human Body Model	4	KV
	Machine Model	300	V
EAS	Single Pulse Avalanche Energy	49	mJ
T _{ope}	Operating Ambient Temperature	-40 ~ 85	°C
T _J	Operating Junction Temperature Range	-40 ~ 150	°C
T _{STG}	Storage Temperature Range	-40 ~ 150	°C
R _{θJC}	Thermal Resistance Junction – Case (*)	95	°C/W

(*) The power dissipation and thermal resistance are evaluated under copper board mounted with free air conditions.



SP6852

Green-Mode Power Switch

ELECTRICAL CHARACTERISTICS

(T_A=25°C, V_{CC}=15V, unless otherwise specified.)

Symbol	Parameter	Conditions	Min.	Typ.	Max.	Unit
Supply Voltage (Vcc Pin)						
I _{stt}	Startup Current			10	20	uA
I _{op}	Operating Current	V _{COMP} = 0V		2.7	4	mA
		V _{COMP} = 3V		2.4		mA
		Protection tripped (OLP, OVP)		1.0		mA
UVLO (off)	Min. Operating Voltage		9.0	10.0	11.0	V
UVLO (on)	Start Threshold Voltage		15.0	16.0	17.0	V
OVP Level	Over Voltage Protection		26	27	29.5	V
Voltage Feedback (Comp Pin)						
I _{sc}	Short Circuit Current			1.25	2.2	mA
V _{op}	Open Loop Voltage			6		V
V _{TH(GM)}	Green Mode Threshold V _{COMP}			2.35		V
Oscillator (RT Pin)						
F _{osc}	Frequency	R _T =100KΩ	60.0	68.0	70.0	KHz
F _{osc(GM)}	Green Mode Frequency	F _s =65.0KHz		22		KHz
F _{dt}	Frequency Variation versus Temp. Deviation	(-40°C ~105°C)			3	%
F _{dv}	Frequency Variation versus V _{CC} Deviation	(V _{CC} =11V-22V)			1	%
Current Sensing (CS Pin)						
V _{cs(off)}	Maximum Input Voltage		0.8	0.85	0.9	V
T _{LEDD}	Leading Edge Blanking Time			280		nS
Z _{cs}	Input impedance		1			MΩ
T _{PD}	Delay to Output			100		nS
MOSFET						
DC (Max)	Maximum Duty Cycle		70	75	80	%
DC (Min)	Minimum Duty Cycle			0		%
V _{DSS}	Drain-Source Breakdown Voltage	V _{GS} =0V, I _D =250uA	700			V
I _{DSS}	Drain-Source Leakage Current	V _{GS} =0V, V _{DS} =600V			10	uA
R _{DS(ON)}	On-State Resistance	V _{GS} =10V, I _D =0.6A			8	Ω
V _{SD}	Forward On Voltage	V _{GS} =0V, I _S =1.4A			1.5	V
C _o	Output capacitance	V _{GS} =0V, V _{DS} =25V, f=1.0MHz		27		pF
T _r	Rising Time			50	200	nS
T _f	Falling Time			30	120	nS
OLP (Over Load Protection)						
T _{LLOLP}	OLP Trip Level			5.0		V
T _{DLOLP}	OLP Delay Time (note)			60		mS

Note: The OLP delay time is proportional to the period of switching cycle. So that, the lower RT value will set the higher switching frequency and the shorter OLP delay time.



SP6852 Green-Mode Power Switch

PERFORMANCE CHARACTERISTICS ($T_A=25^\circ\text{C}$, unless otherwise specified.)

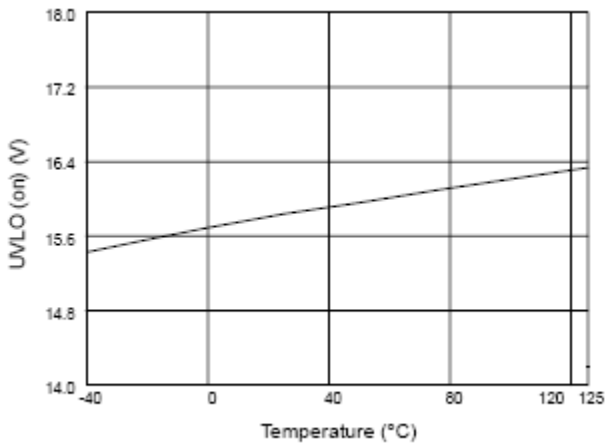

Fig. 1 UVLO (on) vs. Temperature

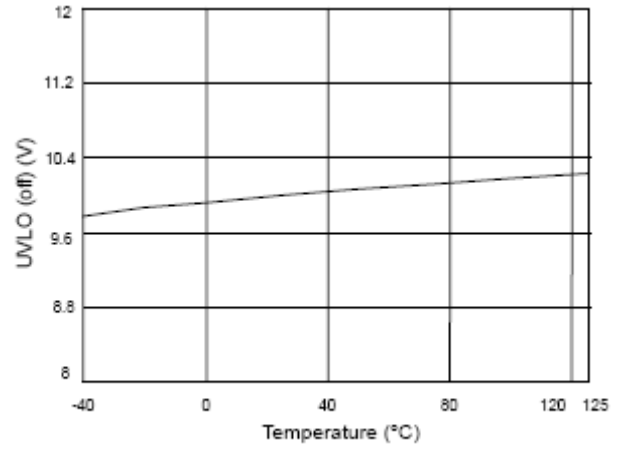

Fig. 2 UVLO (off) vs. Temperature

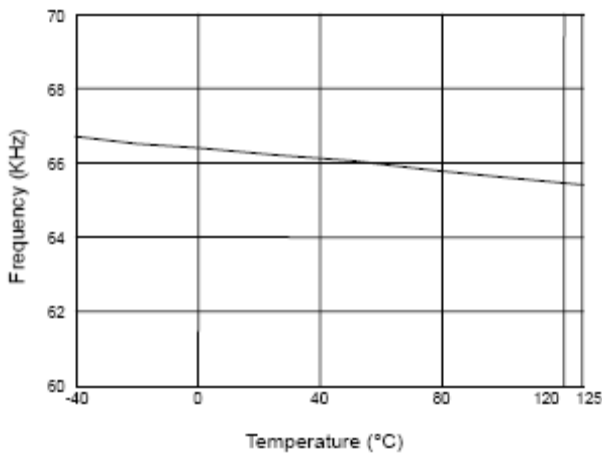

Fig. 3 Frequency vs. Temperature

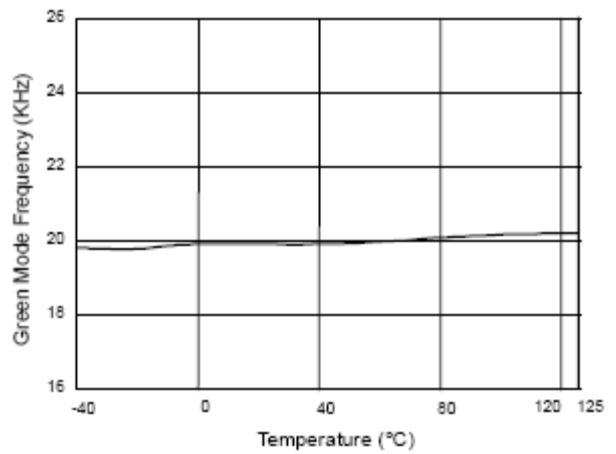

Fig. 4 Green Mode Frequency vs. Temperature

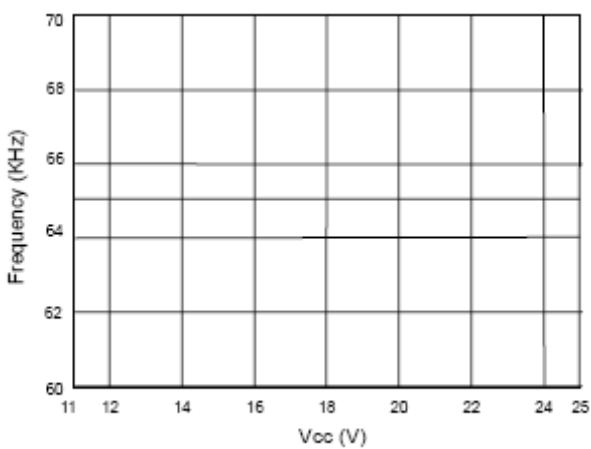

Fig. 5 Frequency vs. Vcc

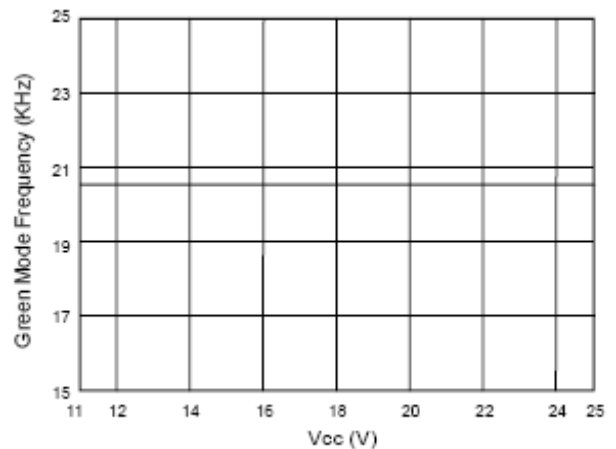

Fig. 6 Green Mode Frequency vs. Vcc



SP6852 Green-Mode Power Switch

PERFORMANCE CHARACTERISTICS ($T_A=25^\circ\text{C}$, unless otherwise specified.)

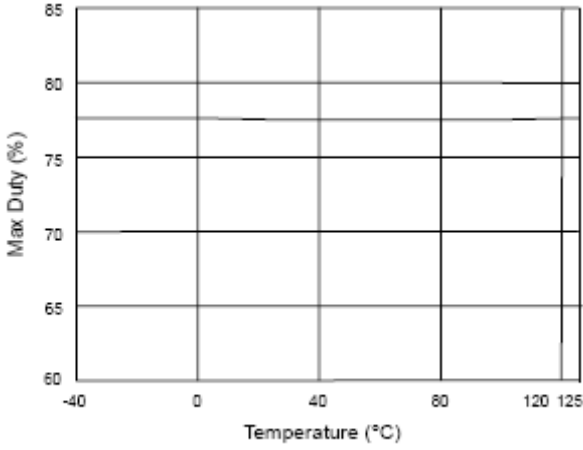

Fig. 7 Max Duty vs. Temperature

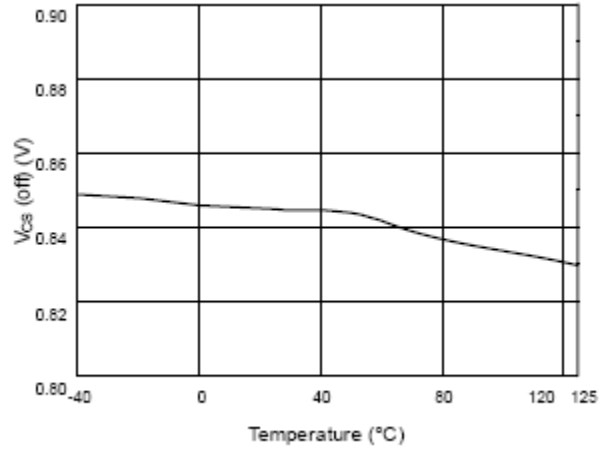

Fig. 8 $V_{CS(off)}$ vs. Temperature

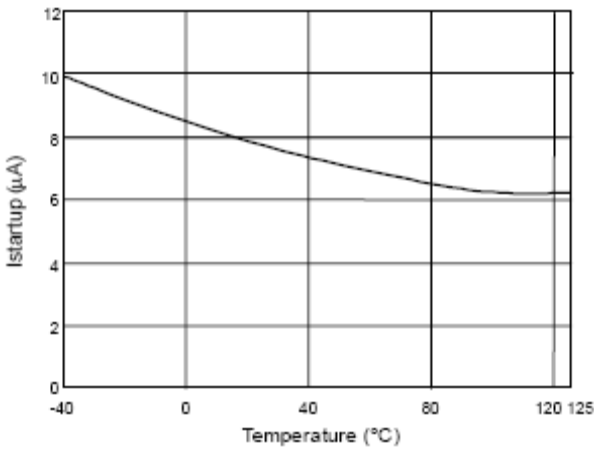

Fig. 9 Startup Current ($I_{start-up}$) vs. Temperature

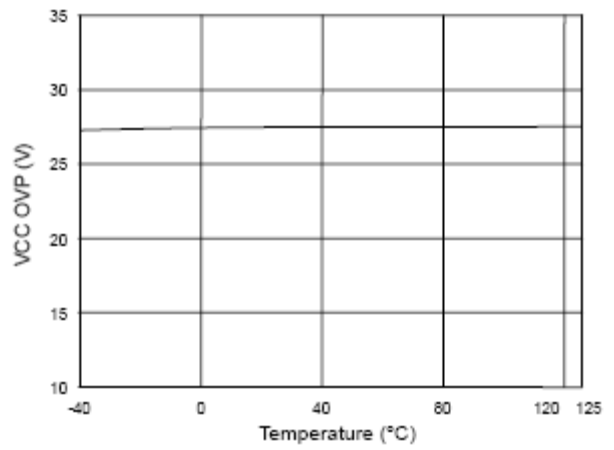

Fig. 10 VCC OVP vs. Temperature

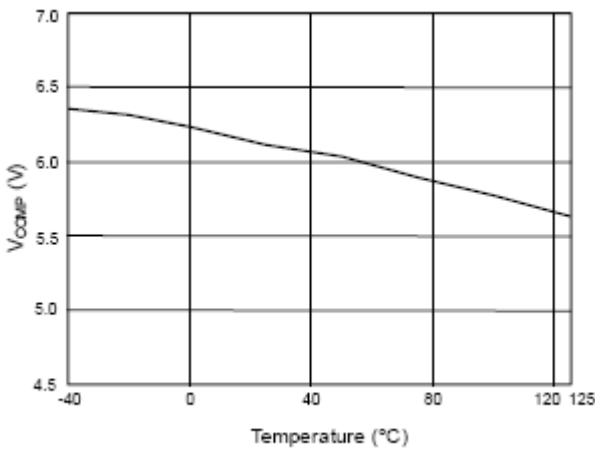

Fig. 11 V_{comp} open loop voltage vs. Temperature

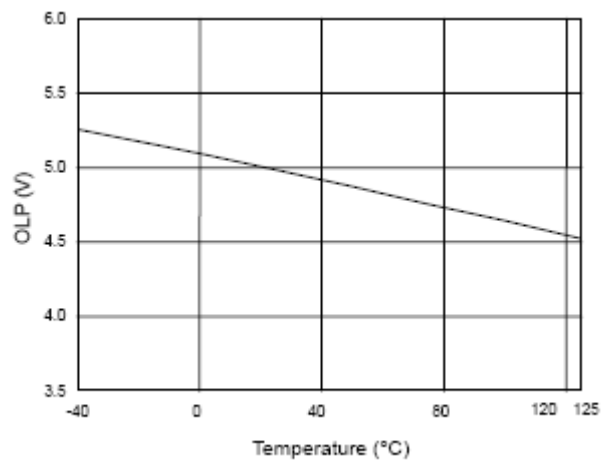
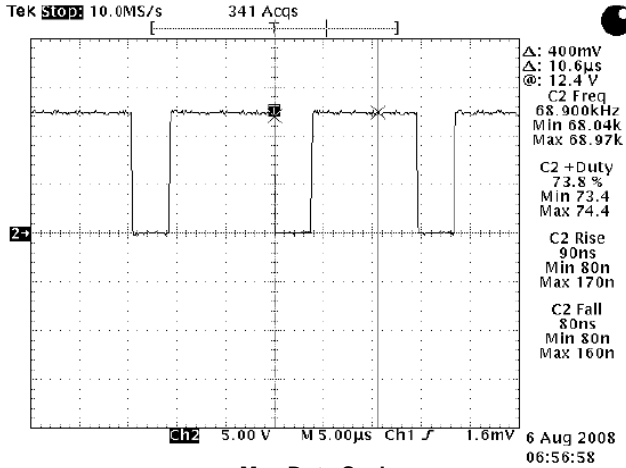

Fig. 12 OLP-Trip Level vs. Temperature



SP6852 Green-Mode Power Switch

PERFORMANCE CHARACTERISTICS ($T_A=25^{\circ}\text{C}$, unless otherwise specified.)



Max Duty Cycle

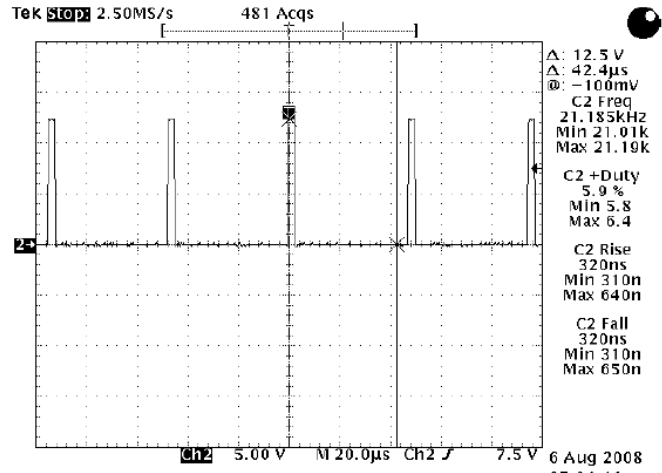

Min Duty Cycle

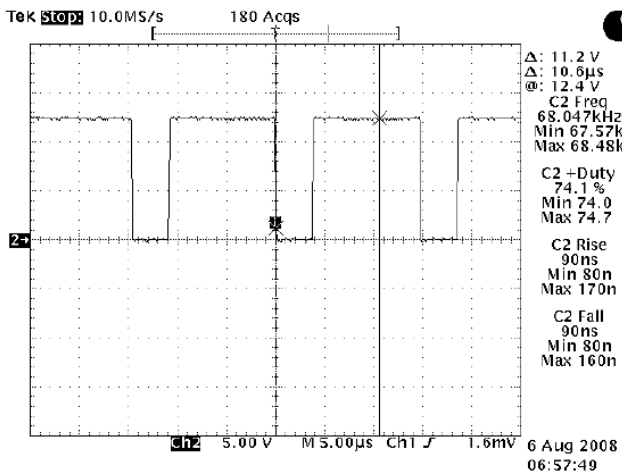

Max Duty Cycle

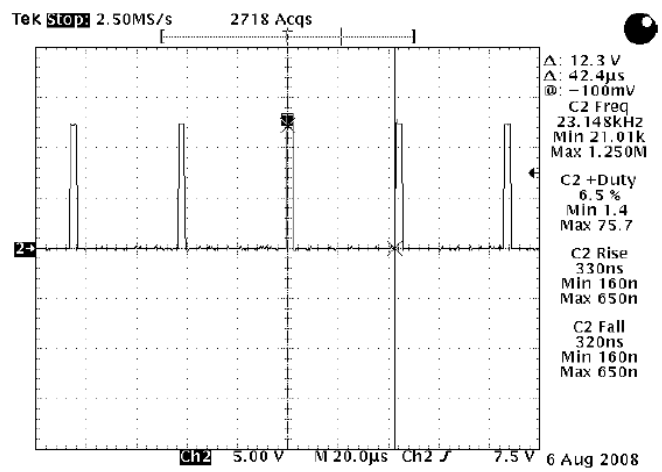

Min Duty Cycle

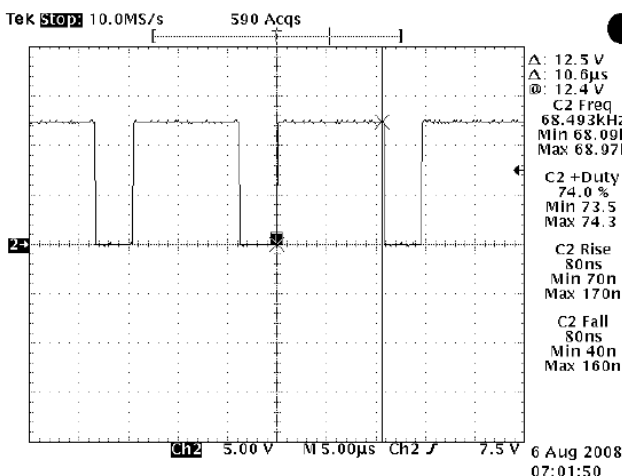

Max Duty Cycle

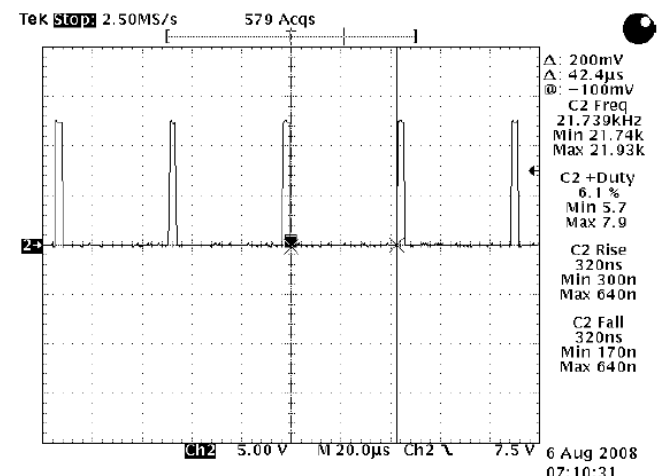

Min Duty Cycle



SP6852 Green-Mode Power Switch

PERFORMANCE CHARACTERISTICS ($T_A=25^{\circ}\text{C}$, unless otherwise specified.)

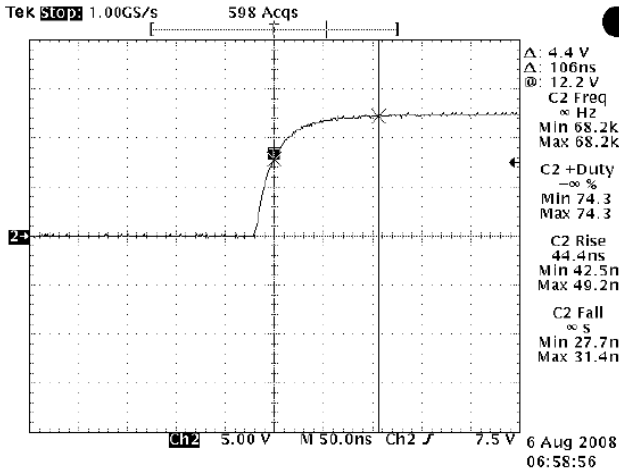

Rising Time Load

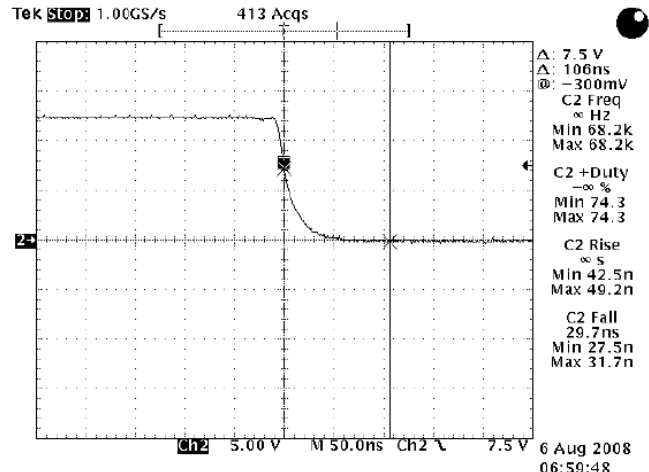

Falling Time Load

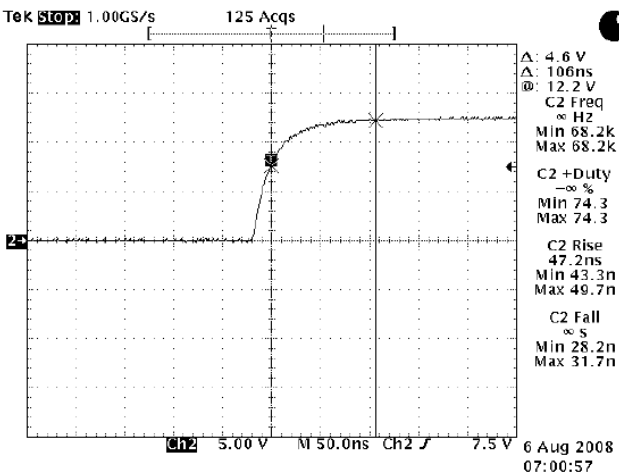

Rising Time Load

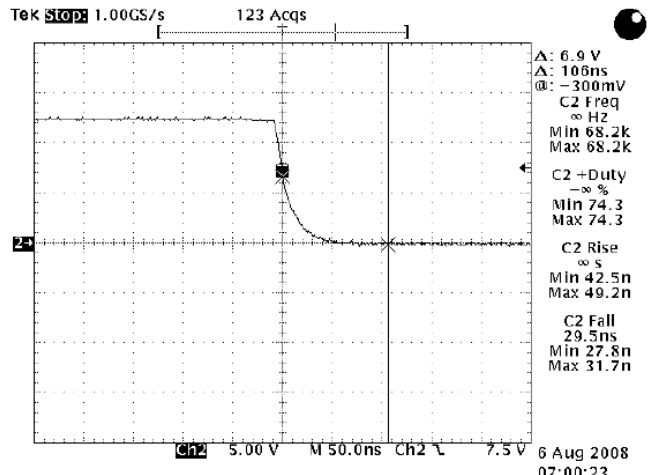

Falling Time Load

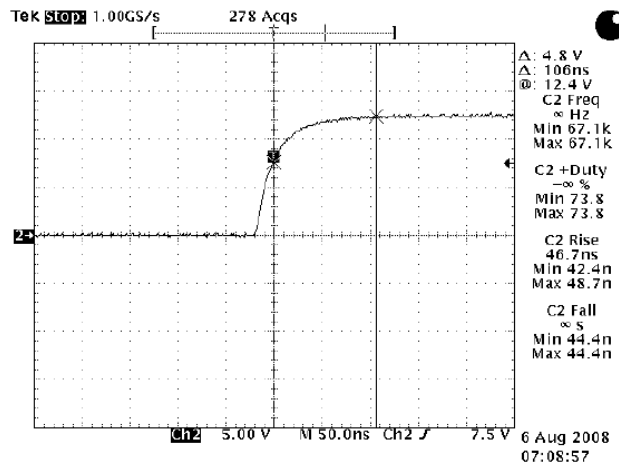

Rising Time Load

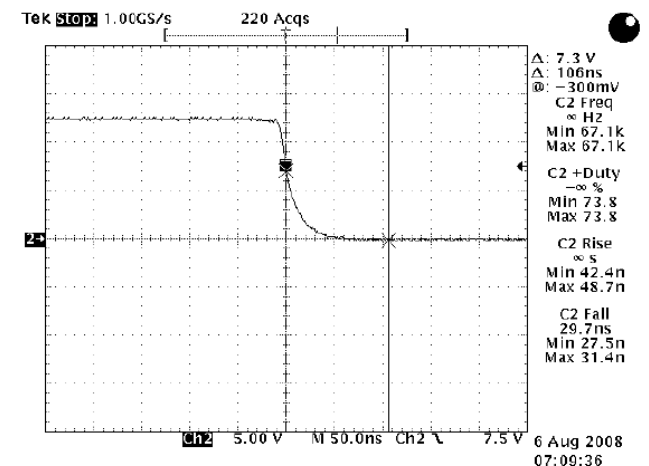

Falling Time Load



SP6852 Green-Mode Power Switch

PERFORMANCE CHARACTERISTICS ($T_A=25^{\circ}\text{C}$, unless otherwise specified.)

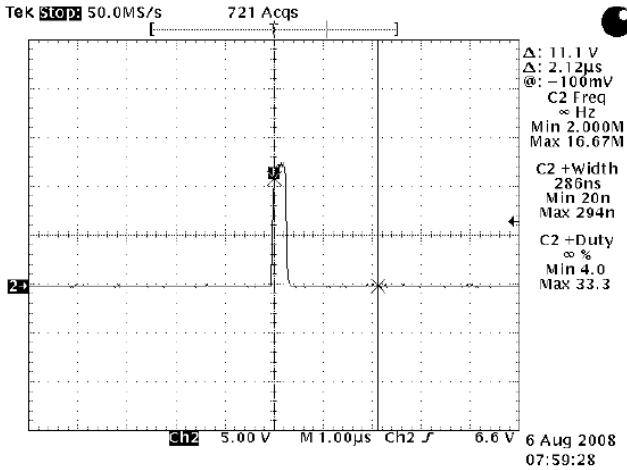

Leading Edge Blanking Time

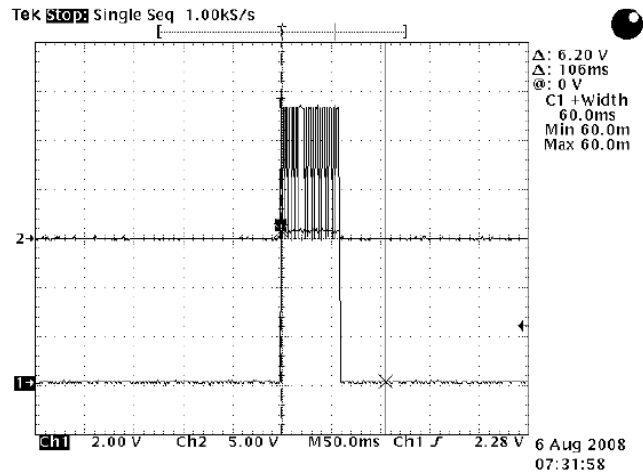

OLP Delay Time

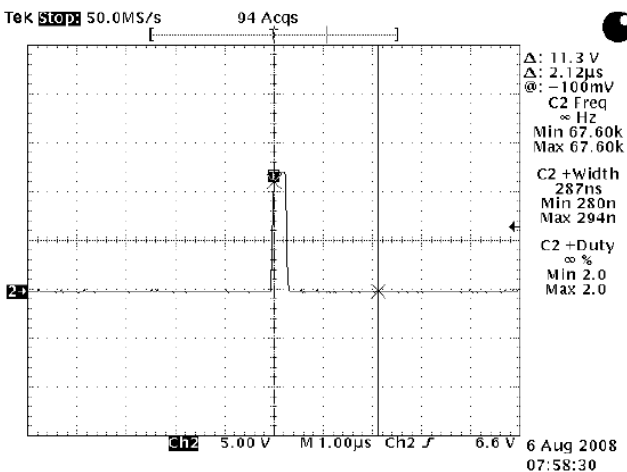

Leading Edge Blanking Time

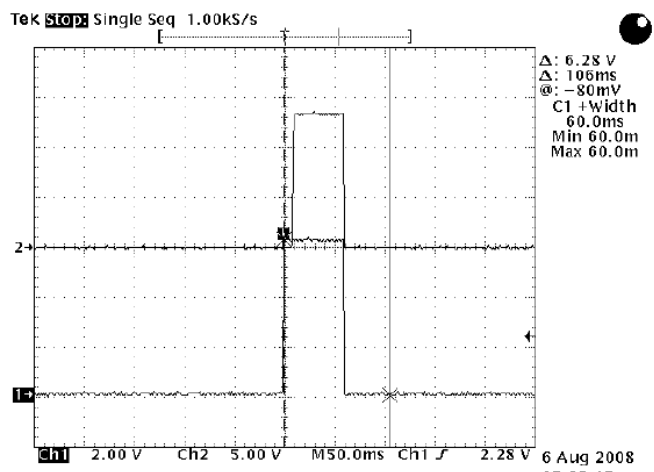

OLP Delay Time

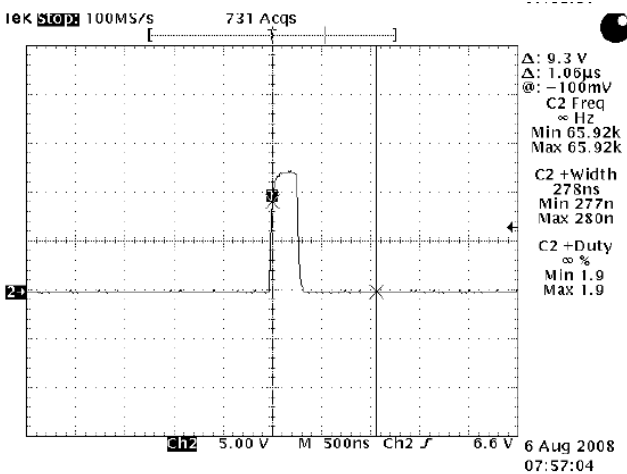

Leading Edge Blanking Time

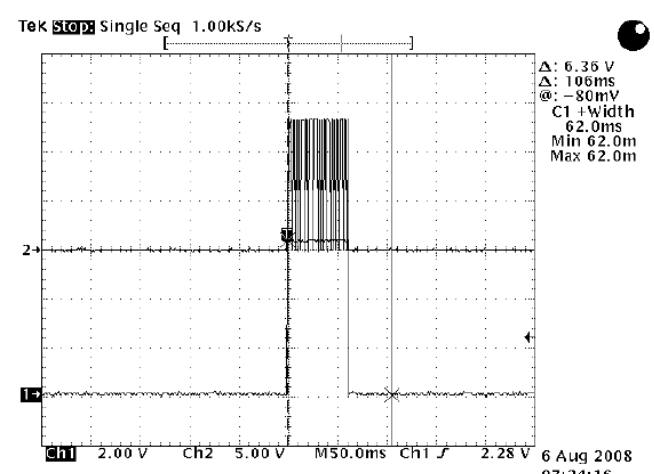

OLP Delay Time



SP6852

Green-Mode Power Switch

DIP- 8P PACKAGE OUTLINE

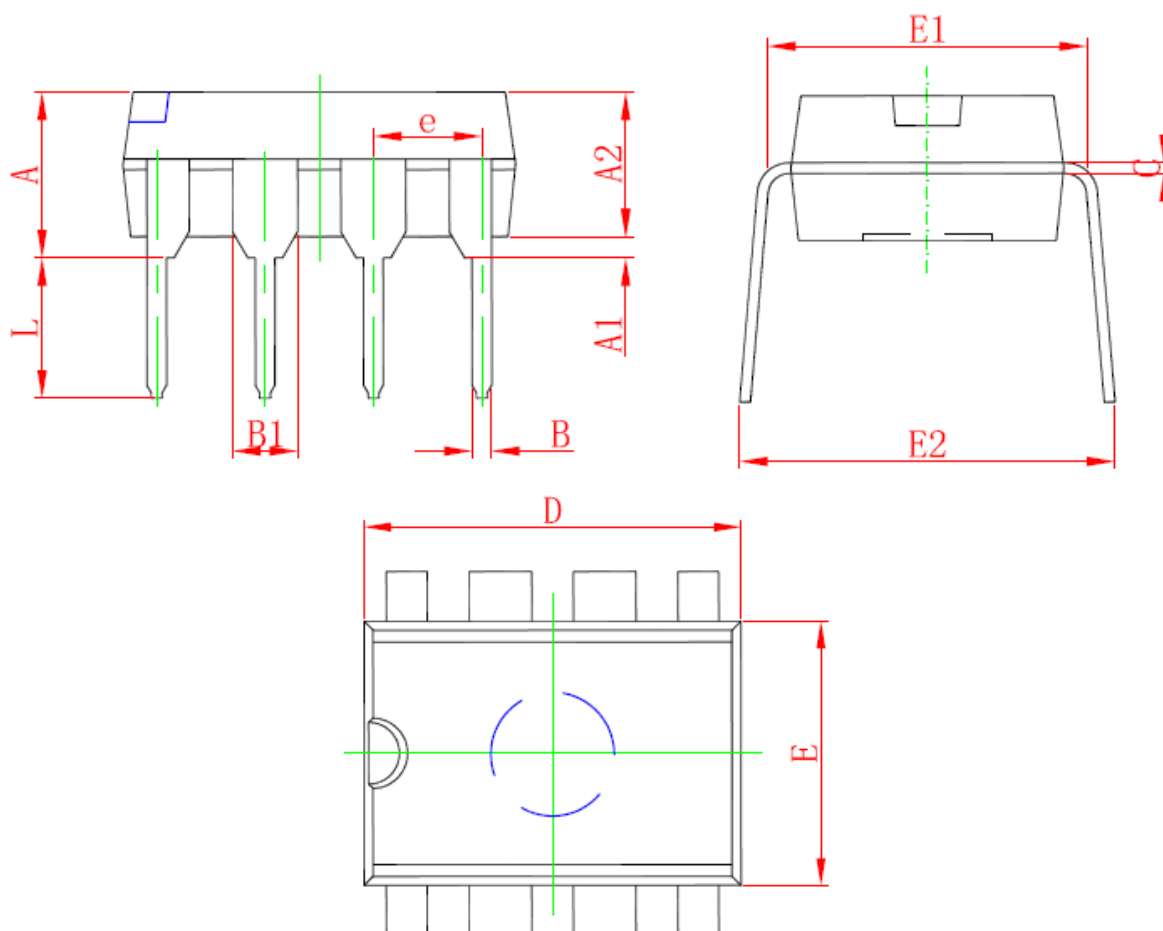

Symbol	Dimensions In Millimeters		Dimensions In Inches	
	Min	Max	Min	Max
A	3.710	4.310	0.146	0.170
A1	0.510		0.020	
A2	3.200	3.600	0.126	0.142
B	0.380	0.570	0.015	0.022
B1	1.524 (BSC)		0.060 (BSC)	
C	0.204	0.360	0.008	0.014
D	9.000	9.400	0.354	0.370
E	6.200	6.600	0.244	0.260
E1	7.320	7.920	0.288	0.312
e	2.540 (BSC)		0.100 (BSC)	
L	3.000	3.600	0.118	0.142
E2	8.400	9.000	0.331	0.354



SP6852

Green-Mode Power Switch

Information provided is alleged to be exact and consistent. SYNC Power Corporation presumes no responsibility for the penalties of use of such information or for any violation of patents or other rights of third parties that may result from its use. No license is granted by allegation or otherwise under any patent or patent rights of SYNC Power Corporation. Conditions mentioned in this publication are subject to change without notice. This publication surpasses and replaces all information previously supplied. SYNC Power Corporation products are not authorized for use as critical components in life support devices or systems without express written approval of SYNC Power Corporation.

©The SYNC Power logo is a registered trademark of SYNC Power Corporation

©2004 SYNC Power Corporation – Printed in Taiwan – All Rights Reserved

SYNC Power Corporation

7F-2, No.3-1, Park Street

NanKang District (NKSP), Taipei, Taiwan, 115, R.O.C

Phone: 886-2-2655-8178

Fax: 886-2-2655-8468

<http://www.syncpower.com>